

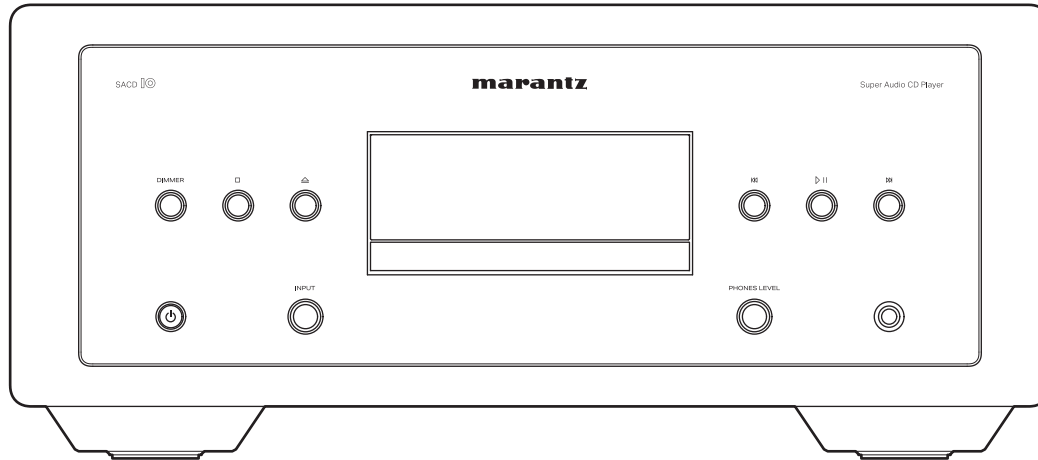

marantz



SACD |  | Super Audio CD Player

Owner's Manual

Accessories	5
Inserting the batteries	6
Operating range of the remote control unit	6
Part names and functions	7
Front panel	7
Rear panel	10
Remote control unit	12

Connections

Connecting an amplifier	19
Connecting to a device with digital audio input connectors	21
Connecting to a device with digital audio output connectors	22
Connecting a PC or Mac	23
Connecting a USB flash drive to the USB port	24
Connecting an external control device	25
FLASHER IR IN jack	25
REMOTE CONTROL connectors	26
Connecting the power cord	28

Playback

Basic operation	30
Turning the power on	30
Switching the power to standby	30
Selecting the input source	31
Switching the display's brightness	31
Turning the illumination and display on/off	32
Playing CDs/Super Audio CDs	33
Playing CDs and Super Audio CDs	33
Setting the top priority playback layer for Super Audio CDs	36
Playing Data CDs and Data DVDs	37
Playing files	38
Playing a USB flash drive	40
Playing files stored on USB flash drives	41
Using as a D/A converter	43
Connecting and playing back from a computer (USB-DAC)	44
Connecting and playing back from a digital device (Coaxial/Optical 1/Optical 2)	52



Settings

Menu map	53
Menu operation	54
Audio	55
Filter	55
Dither	55
Noise Shaper	56
Digital Out	56
HP Amplifier Gain	57
Resume Play	57
General	58
Illumination	58
Auto-Standby	58
Disabling amplifier/streaming preamplifier operating mode on remote control	59
Disabling amplifier operating mode	60
Disabling streaming preamplifier operating mode	60
Setting the device to be operated by the volume buttons on the remote control	61
Setting the device to be operated by the volume buttons in SACD player operating mode	62

Tips

Tips	64
Troubleshooting	66
Power does not turn on / Power is turned off	67
Operations cannot be performed through the remote control unit	68
Display on this unit shows nothing	69
No sound comes out	69
Sound is interrupted or noise occurs	70
Desired sound does not come out	70
USB flash drives cannot be played back	71
Cannot playback Discs	72
There is a delay before the disc tray starts to open	72
Music files on PC or Mac cannot be played back (USB-DAC)	73
Audio from digital devices cannot be played back (Coaxial/Optical)	73



Appendix



Playing back Discs	74
Playing back a USB flash drives	77
Playback order of music files	79
About discs and files	79
Cautions on using media	80
Loading discs	80
How to handle media	81
Cleaning discs	81
Digital input	82
Explanation of terms	83
Specifications	85
Index	88



Thank you for purchasing this Marantz product. To ensure proper operation, please read this owner's manual carefully before using the product. After reading this manual, be sure to keep it for future reference.

Accessories

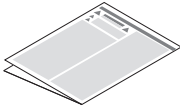
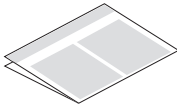
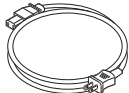
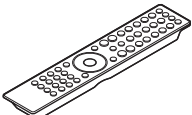
Check that the following parts are supplied with the product.

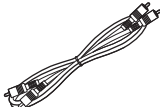
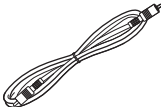
 Quick Start Guide	 Safety Instructions	 Warranty (for North America model only)	 Power cord
 Remote control unit (RC004PMND)	 2x R03/AAA batteries	 Audio cable	 Remote connector cable



Inserting the batteries

- 1 Remove the rear lid in the direction of the arrow and remove it.

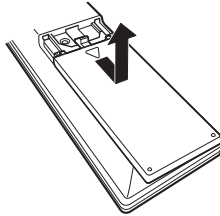

- 2 Insert two batteries correctly into the battery compartment as indicated.

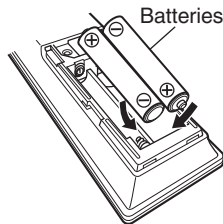

- 3 Put the rear lid back on.

NOTE

- To prevent damage or leakage of battery fluid:
 - Do not use a new battery together with an old one.
 - Do not use two different types of batteries.
- Remove the batteries from the remote control unit if it will not be in use for long periods.
- If the battery fluid should leak, carefully wipe the fluid off the inside of the battery compartment and insert new batteries.

Operating range of the remote control unit

Point the remote control unit at the remote sensor when operating it.

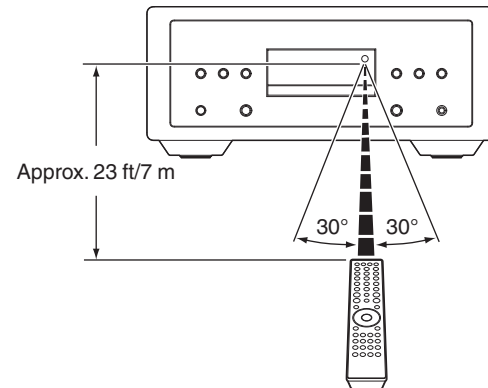

Part names and functions

Front panel

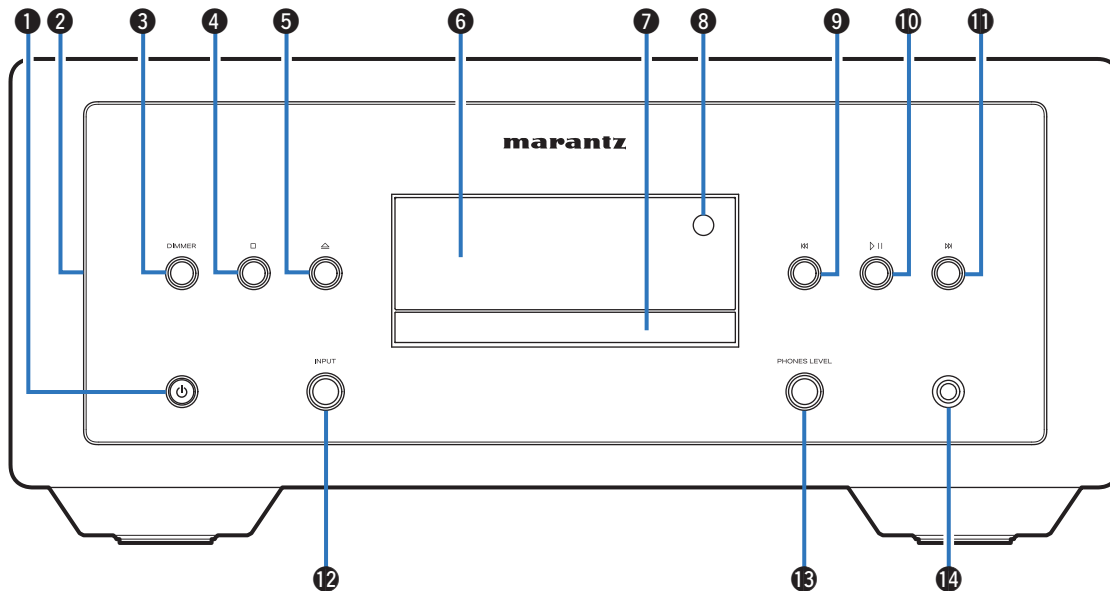

For details, see the next page.



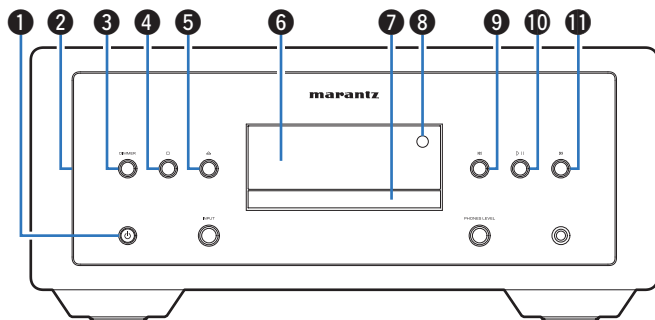

1 Power (⏻) button/indicator

- This turns the power on/off (standby). (👉 p. 30)
- This is lit as follows according to the power status:
 - Power on : White
 - Standby : Off
 - When the protection circuit is activated : Orange (blinking)

2 Illumination

This illuminates when the power is turned on. Brightness can be changed and lighting turned off.

- "Turning the illumination and display on/off" (👉 p. 32)
- "Illumination" (👉 p. 58)

3 DIMMER button

This switches the brightness of the display. (👉 p. 31)

4 Stop button (□)

Press this button to stop during playback.

5 Disc tray open/close button (⏏)

Opens and closes the disc tray. (👉 p. 33)

6 Display

Various information is displayed here.

7 Disc tray

Used to insert a disc.

8 Remote control sensor

This receives signals from the remote control unit. (👉 p. 6)

9 Reverse-skip button (⏮)

Press this button during playback to restart the current track or play the previous track.

10 Play/Pause button (⏮)

Press this button to pause during playback. If pressed while paused or stopped, resumes playback.

11 Forward-skip button (⏭)

Press this button during playback to play the next track.

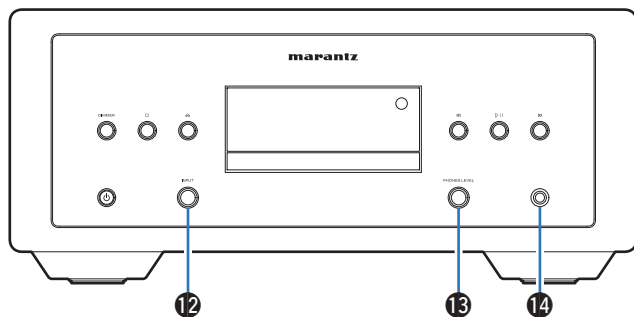

**12 INPUT selector knob**

This selects the input source. (👉 p. 31)

13 Headphone volume control knob (PHONES LEVEL)

Adjusts the headphone volume.

14 Headphones jack

Used to connect headphones.

NOTE

- To prevent hearing loss, do not raise the volume level excessively when using headphones.



Rear panel

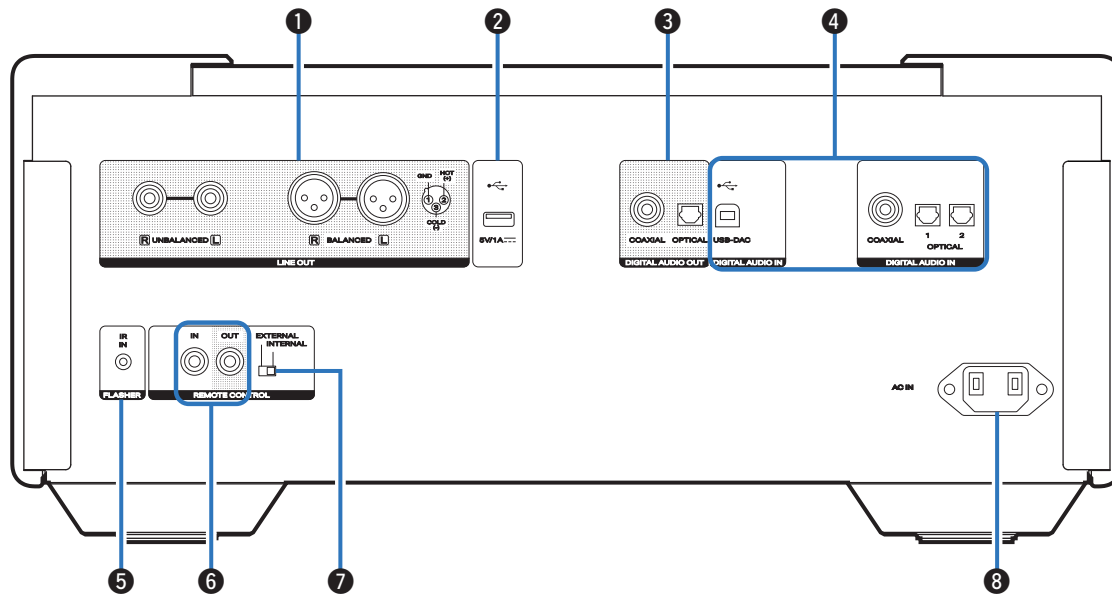

For details, see the next page.



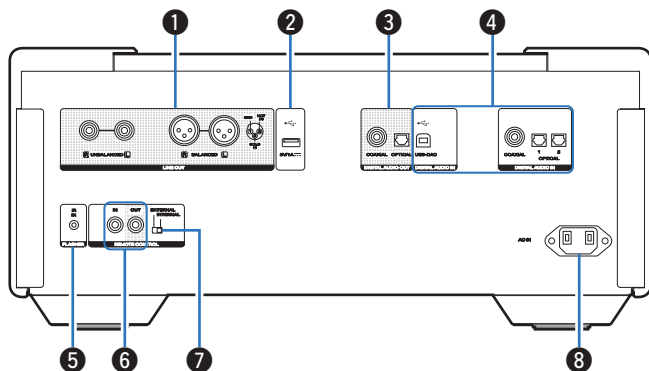

1 LINE OUT connectors

Used to connect devices equipped with analog audio inputs connectors or an external amplifier. (☞ p. 19)

2 USB port (☞)

This is used to connect USB storages (such as USB flash drives). (☞ p. 24)

3 DIGITAL AUDIO OUT connectors (COAXIAL/OPTICAL)

Used to connect an amplifier or D/A converter that has a digital input connectors. (☞ p. 21)

4 DIGITAL AUDIO IN connectors

- Used to connect devices equipped with digital audio output connectors. (☞ p. 22)
- Used to connect a computer. (☞ p. 23)

5 FLASHER IR IN jack

Used to connect a control box, etc. (☞ p. 25)

6 Remote control input/output connectors (REMOTE CONTROL)

Used to connect to a Marantz audio device that is compatible with the remote control function. (☞ p. 26)

7 EXTERNAL/INTERNAL switch

Turn this switch to “EXTERNAL” to operate the unit by pointing the remote control at the amplifier connected to this unit using the remote control connection. (☞ p. 26)

8 AC inlet (AC IN)

Used to connect the power cord. (☞ p. 28)



Remote control unit

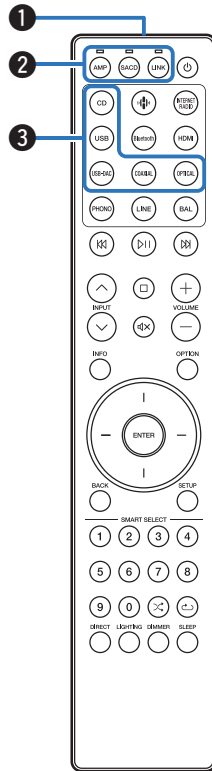

The remote control provided with this unit can control a Marantz amplifier and streaming preamplifier.

- “Amplifier operations” (📖 p. 15)
- “Streaming preamplifier operations” (📖 p. 16)

■ Operating this unit

To operate this unit, press SACD button to switch the remote control operating mode to this unit.

① Remote control signal transmitter

This transmits signals from the remote control unit. (📖 p. 6)

② Remote mode select buttons/indicators (AMP/SACD/LINK)

- These switch the remote control operating mode (AMP/SACD/LINK).
- The indicator will light up according to the device being operated.

③ Input source select buttons (CD/USB/USB-DAC/COAXIAL/OPTICAL)

This selects the input source. (📖 p. 31)



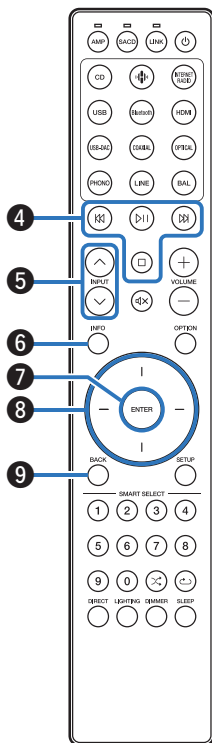

4 System buttons

These perform playback related operations.

- Play/Pause button (⏮⏭)
Press this button to pause during playback. If pressed while paused or stopped, resumes playback.
- Forward-skip button (⏭)
Press this button during playback to play the next track.
- Reverse-skip button (⏮)
Press this button during playback to restart the current track or play the previous track.
- Stop button (⏹)
Press this button to stop during playback.

5 INPUT buttons (^ v)

This selects the input source. (👉 p. 31)

6 Information button (INFO)

This switches the track information shown in the display during playback.

7 ENTER button

This determines the selection.

8 Cursor buttons

These select items.

9 BACK button

Returns to the previous item.



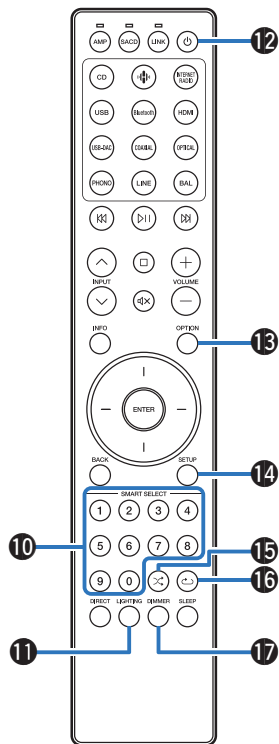

10 Number buttons (0 – 9)

These enter numbers into the unit.

11 LIGHTING button

This turns the illumination and display on/off. (☞ p. 32)

12 Power (⏻) button

This turns the power on/off (standby). (☞ p. 30)

13 OPTION button

- Selects the top priority playback layer for Super Audio CDs. (☞ p. 36)
- Selects the playback range of the data CD/DVD. (☞ p. 39)
- Selects the playback range of the USB flash drive. (☞ p. 42)

14 SETUP button

The setting menu is displayed on the display. (☞ p. 54)

15 Random button (✂)

Switches the random playback.

16 Repeat button (↺)

Switches to the repeat playback.

17 DIMMER button

Adjust the display brightness of this unit. (☞ p. 31)



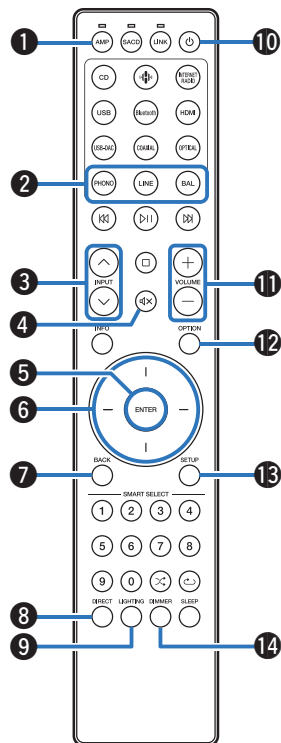

■ Amplifier operations

A Marantz amplifier can be operated.

To operate amplifier, press AMP button to switch the remote control to the amplifier operation mode.

- 1 Remote mode select button (AMP)
- 2 Input source select buttons (PHONO/LINE/BAL)
- 3 INPUT buttons (^/∨)
- 4 Mute button (M)
- 5 ENTER button
- 6 Cursor buttons
- 7 BACK button
- 8 DIRECT button
- 9 LIGHTING button
- 10 Power (P) button
- 11 VOLUME buttons (+/-)
- 12 OPTION button
- 13 SETUP button
- 14 DIMMER button



- The remote control may not operate some products.



■ Streaming preamplifier operations

A Marantz streaming preamplifier can be operated.

To operate streaming preamplifier, press LINK button to switch the remote control to the streaming preamplifier operation mode.

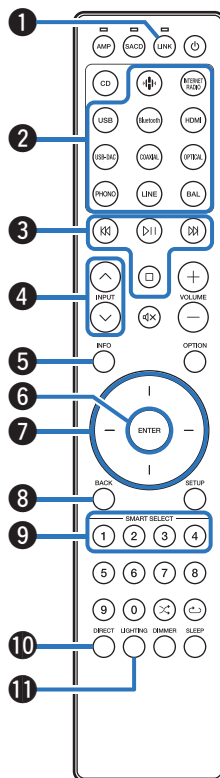

- ❶ Remote mode select button (LINK)
- ❷ Input source select buttons
- ❸ System buttons
- ❹ INPUT buttons (^ v)
- ❺ Information button (INFO)
- ❻ ENTER button
- ❼ Cursor buttons
- ❽ BACK button
- ❾ SMART SELECT 1 - 4 buttons
- ❿ DIRECT button
- ⓫ LIGHTING button



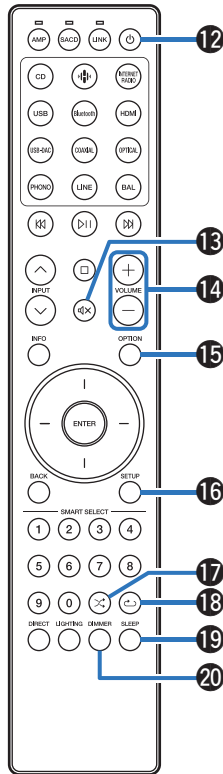

- 12 Power (⏻) button
- 13 Mute button (🔇)
- 14 VOLUME buttons (+/-)
- 15 OPTION button
- 16 SETUP button
- 17 Random button (🔀)
- 18 Repeat button (↺)
- 19 SLEEP button
- 20 DIMMER button



- The remote control may not operate some products.



■ Contents







Connecting an amplifier	19
Connecting to a device with digital audio input connectors	21
Connecting to a device with digital audio output connectors	22
Connecting a PC or Mac	23
Connecting a USB flash drive to the USB port	24
Connecting an external control device	25
Connecting the power cord	28

NOTE

- Do not plug in the power cord until all connections have been completed.
- Do not bundle power cords together with connection cables. Doing so can result in humming or noise.

■ Cables used for connections

Provide necessary cables according to the devices you want to connect.

Audio cable (included)	
Balance cable (not included)	
Remote connector cable (included)	
Optical cable (not included)	
Coaxial digital cable (not included)	
USB cable (not included)	
Monaural mini-plug cable (not included)	



Connecting an amplifier

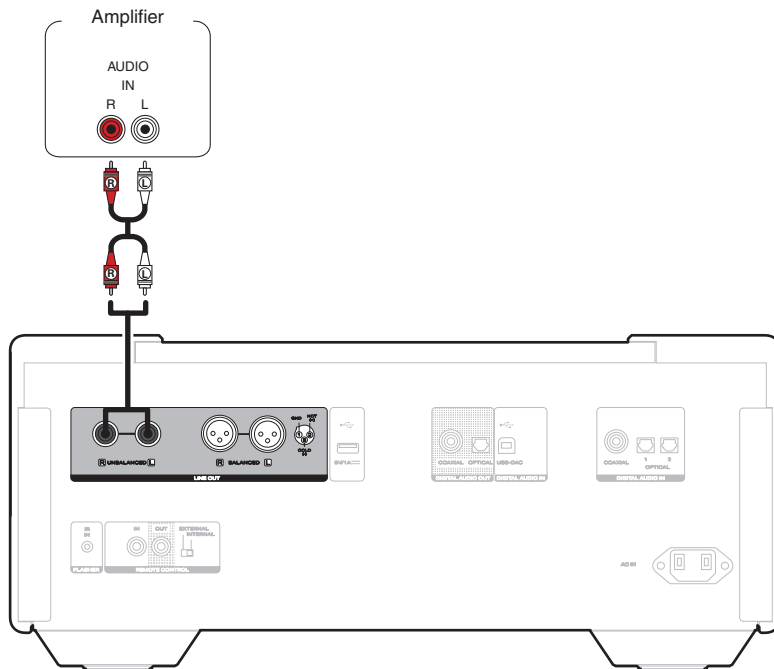

■ About balanced connectors

This unit has both unbalanced and balanced connectors. The balanced connectors have three pins, making it possible to transmit audio signals as a balanced signal, reducing the effect of external noise. They also have a removable lock mechanism, which reduces shaking in the connector area, making the connection highly reliable.



- The balanced connection is an all-stage balanced configuration.

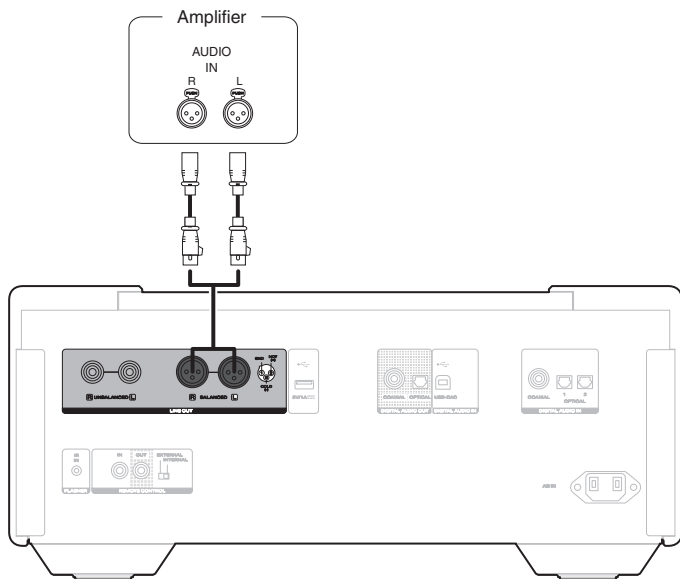

■ Phases of the balanced connectors

The XLR connector is internally wired in either of the following two systems. This unit employs the European system.

- European system (② PIN=HOT / ③ PIN=COLD)

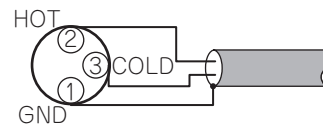

- USA system (② PIN=COLD / ③ PIN=HOT)

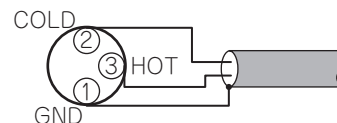

If a product that employs the USA system is connected with this unit via a balanced cable, the output signal may be phase-inverted. To correct the inversion, connect the one side XLR connector reversing the ② PIN and ③ PIN.



Connecting to a device with digital audio input connectors

You can enjoy digital audio playback by connecting an amplifier or D/A converter that has a digital audio connector to this unit.

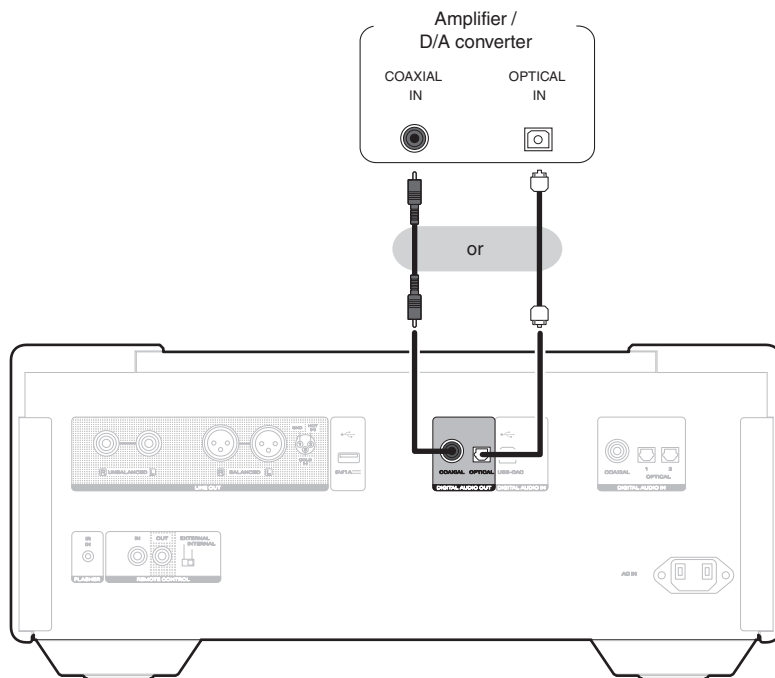

NOTE

- Digital audio output stops during playback of the DSD signals and linear PCM signals with a sampling frequency of 352.8/384 kHz using this unit's USB-DAC.
- Digital audio output stops during playback of the DSD files via USB flash drive, Data CDs and Data DVDs.
- Digital audio output stops during playback of the HD layer of Super Audio CDs.
- Digital audio output can be set on/off using "Digital Out" in the setup menu. (☞ p. 56)
- To connect recorder that has a digital audio connector isn't recommended.



Connecting to a device with digital audio output connectors

Use this connection to input digital audio signals to this unit, and convert the signals for playback using the D/A converter of this unit. (🔍 p. 43)

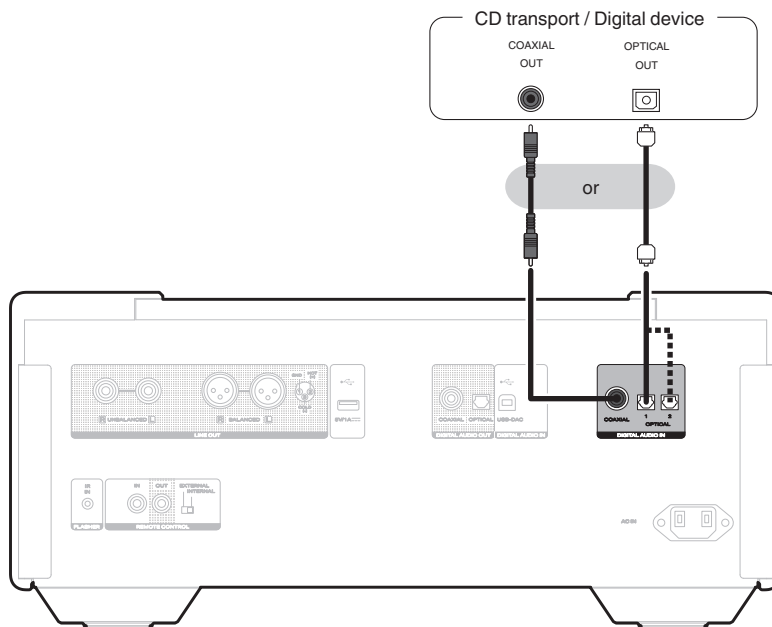

■ Specifications of supported audio formats

See “Digital input” (🔍 p. 82).



Connecting a PC or Mac

By connecting a computer to the USB-DAC port on the rear panel of this unit using a commercially available USB connecting cable, this unit can be used as a D/A converter. (🔗 p. 43)

NOTE

- Before USB connecting this unit to your computer, install the driver software in your computer. (🔗 p. 44)
- Download the driver software from the SACD 10 page of the Marantz website.
- Use a cable that is 10 ft (3 m) or less to connect to the computer.

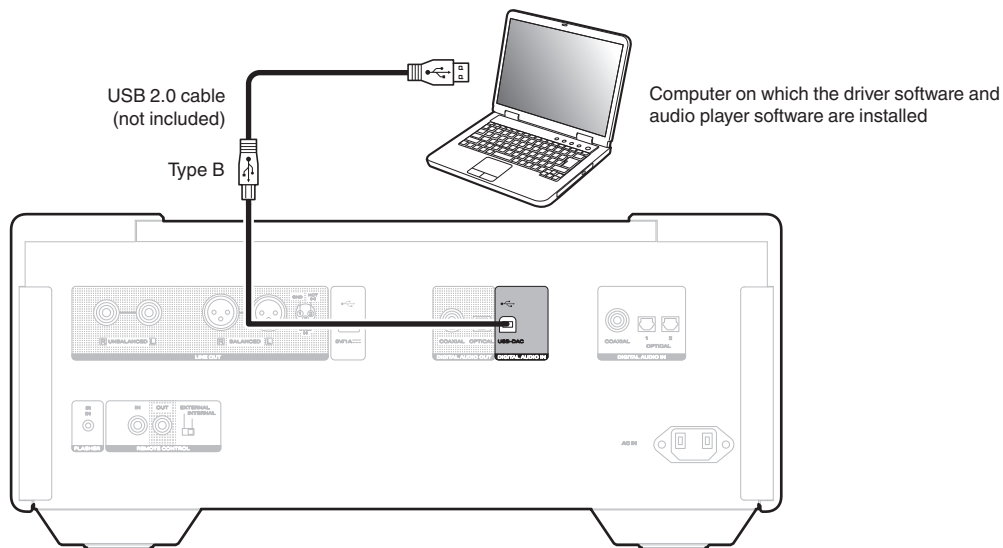

Connecting a USB flash drive to the USB port

For operating instructions see “Playing a USB flash drive”. (📖 p. 40)

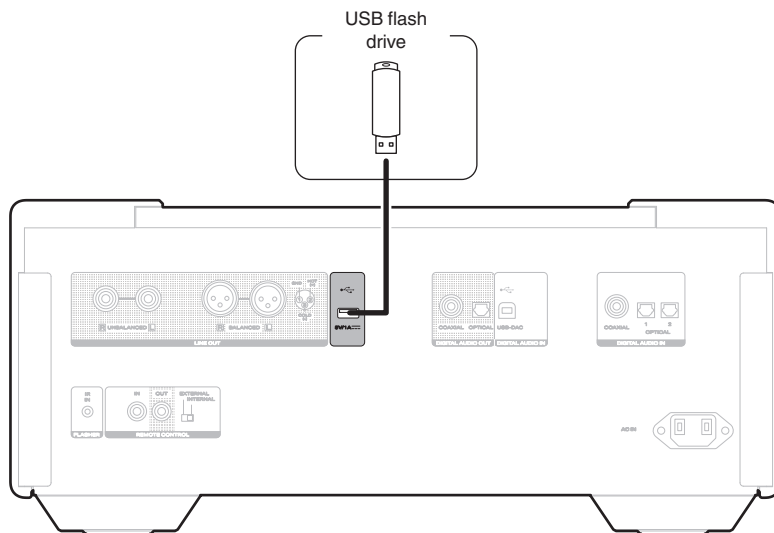

- Marantz does not guarantee that all USB flash drives will operate or receive power. When using a portable USB hard disk drive (HDD) which came with an AC adapter, use that device's supplied AC adapter.

NOTE

- USB flash drives will not work via a USB hub.
- It is not possible to use this unit by connecting the rear panel's USB port to a PC via a USB cable. Connection to a computer is possible via the digital input USB-DAC port (Type B) on the rear panel.
- Do not use an extension cable when connecting a USB flash drive. This may cause radio interference with other devices.



Connecting an external control device

FLASHER IR IN jack

This unit can be controlled by connecting a control box or other control device to this unit.

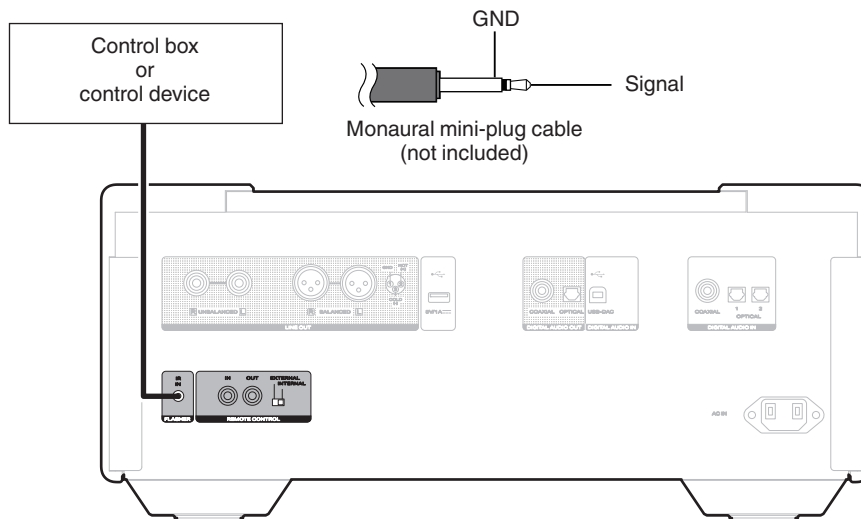

- To use the FLASHER IR IN jack, set the EXTERNAL/INTERNAL switch to "INTERNAL".



REMOTE CONTROL connectors

When this unit is connected in combination with MODEL 10 and LINK 10n, the following functions will be available.

- A function that transmits remote control signals received by the MODEL 10 or LINK 10n to this unit
- Synchronizing the power operations of this unit, MODEL 10 and LINK 10n
 - When this unit is turned on, MODEL 10 and LINK 10n will also be turned on.
 - When this unit power is set to standby, MODEL 10 and LINK 10n power will also be set to standby.

Next, configure the “Connection” and “Setting”.

■ Connection

Use the included remote connector cable to connect the REMOTE CONTROL IN connector of this unit to REMOTE CONTROL OUT connector of MODEL 10 or LINK 10n.

■ Setting

1. Turn the EXTERNAL/INTERNAL switch on this unit to “EXTERNAL”.
 - This setting will disable remote sensor reception of this unit.
2. Turn the EXTERNAL/INTERNAL switch on MODEL 10 or LINK 10n to “INTERNAL”.
 - To operate the unit, point the remote control at the remote sensor of MODEL 10 or LINK 10n.



- To use this unit by itself without connecting an amplifier, turn the switch to “INTERNAL”.



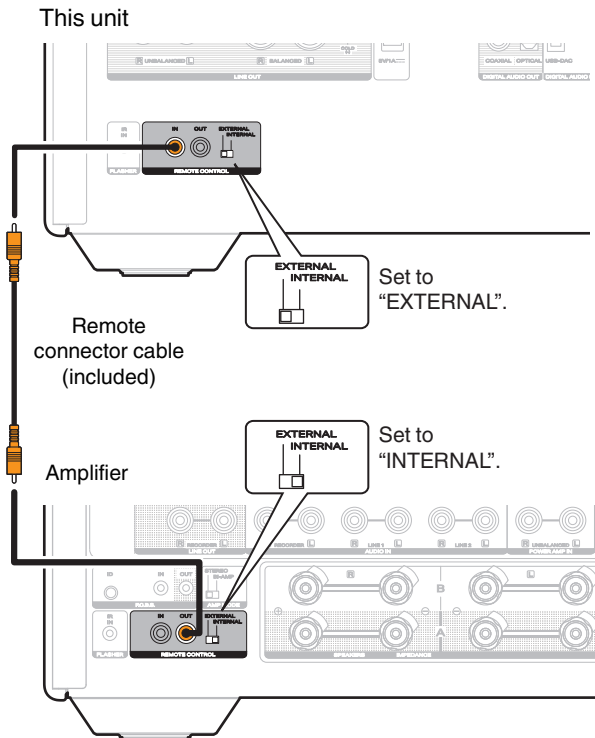

Connecting the power cord

After completing all the connections, insert the power plug into the power outlet.

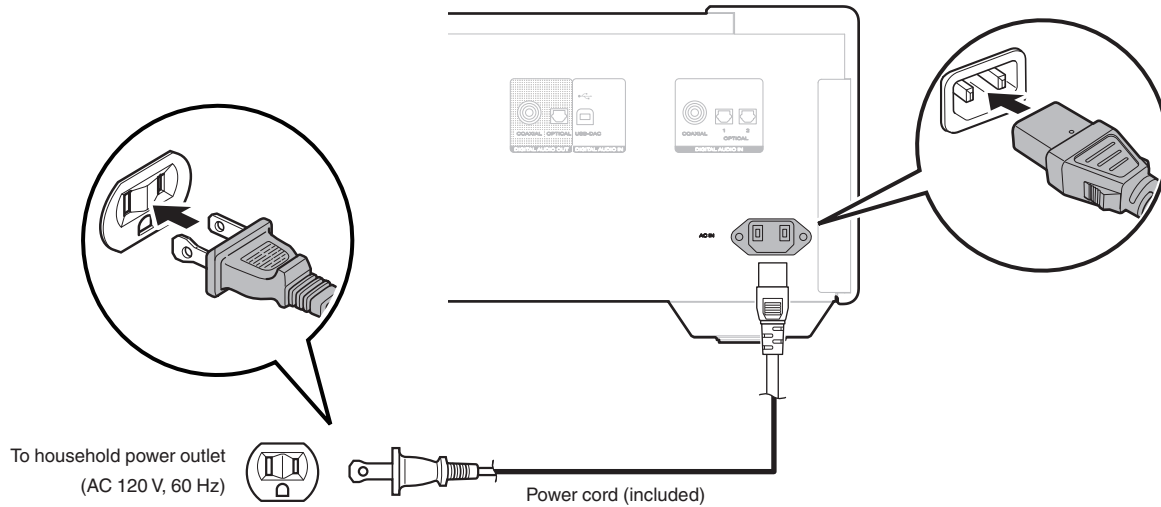

■ Contents

Basic operation	30
Playing CDs/Super Audio CDs	33
Playing Data CDs and Data DVDs	37
Playing a USB flash drive	40
Using as a D/A converter	43



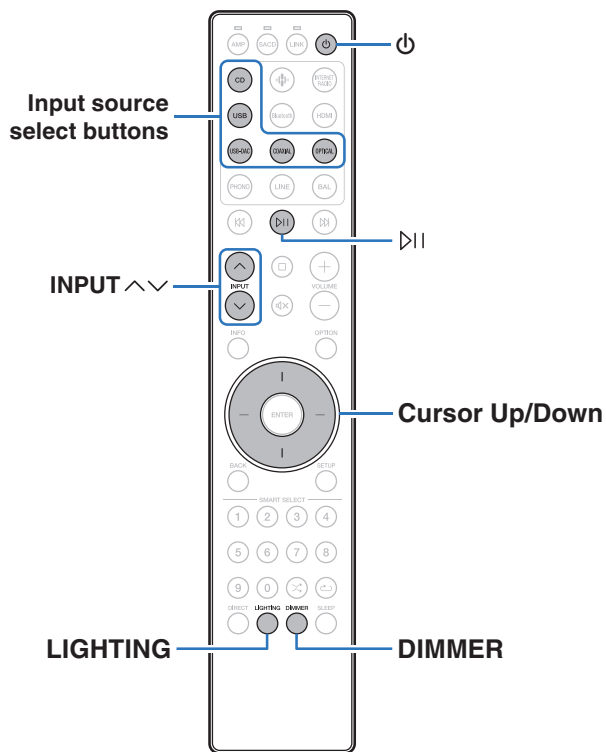

Basic operation



Turning the power on

1 Press  to turn on power to the unit.



- You can also press  on the main unit to turn on power from standby mode.
- You can also press  to turn on power from standby mode.

Switching the power to standby

1 Press .

The unit switches to standby mode.



- You can also switch the power to standby by pressing  on the main unit.

NOTE

- Power continues to be supplied to some of the circuitry even when the power is in the standby mode. When leaving home for long periods of time or when going on vacation, unplug the power cord from the power outlet.



Selecting the input source

1 Press input source select buttons (CD/USB/USB-DAC/COAXIAL/OPTICAL) to be played back.

The selected input source appears on the display.



- You can also select the input source by turning INPUT selector on the main unit.
- This unit switches between Optical 1 and Optical 2 each time OPTICAL is pressed.
- You can also select the input source by using INPUT \wedge \vee .

Switching the display's brightness

The display brightness can be adjusted from 100 % to Off (0 %) in steps of 5 %. Switching the display off reduces a source of noise that affects sound quality, enabling higher sound quality playback.

1 Press DIMMER.

The dimmer menu screen is displayed on the display.

2 Use Cursor Up/Down buttons to adjust the brightness of the display.

- You can also adjust the brightness by pressing DIMMER.



- The display brightness is set to 100 % by default.
- If buttons are operated when the display is off, information is temporarily displayed at 100 %.
- The display brightness setting is synchronized with the "Illumination" - "Display" setting in the settings menu. (☞ p. 58)
- DIMMER does not work when LIGHTING is pressed and turned off.



Turning the illumination and display on/off

Turn on/off the illumination and display. Switching the illumination and display off reduces a source of noise that affects sound quality, enabling higher sound quality playback.

1 Press LIGHTING.

- Each time the button is pressed, the illumination and display are turned on/off.



- In the Settings menu, "Illumination" allows you to set the brightness of the illumination and display. (🔍 p. 58)
- When LIGHTING is pressed and lit, the illumination and display light up to the brightness set in "Illumination" in the Settings menu. (🔍 p. 58)



Playing CDs/Super Audio CDs

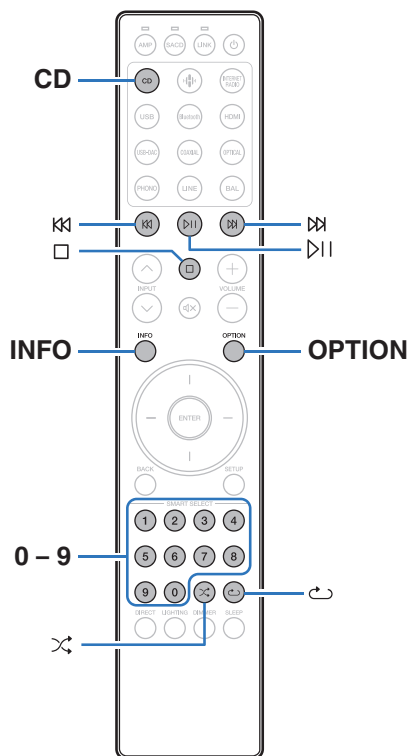

Playing CDs and Super Audio CDs

- 1 Press **CD** to switch the input source to “CD”.
- 2 Press **△** on the main unit to insert a disc.



- You can also close the disc tray by pressing **▷||**. This automatically starts playback.

- 3 When playing back a Super Audio CD, press **OPTION** to set the playback layer.

STEREO (Default):	Plays back the 2-channel area of the Super Audio CD.
MULTI:	Plays back the multi-channel area of the Super Audio CD. The analog output of this unit outputs a down-mixed 2-channel signal.
CD:	Plays back the CD layer of the Super Audio CD.



- If this operation is not performed, reading begins automatically based on the top priority playback layer setting. (ⓘ p. 36)



4 Press ▶II.

The ▶ indicator lights on the display. Playback starts.

NOTE

- Do not place any foreign objects in the disc tray. Doing so could damage the unit.
- Do not push the disc tray in by hand when the power is turned off. Doing so could damage the unit.

Operation buttons	Function
▶II	Playback / Pause
□	Stop
⏮ ⏭	Skip to previous track / Skip to next track (Press and hold) Fast-reverse / Fast-forward
0 - 9	Select the track
⌘	Random playback
↺	Repeat playback <ul style="list-style-type: none"> • Switching between All-track repeat and Single-track repeat.
INFO	Time display switching <ul style="list-style-type: none"> • Switching between elapsed time of the current track, remaining time of the current track and remaining time of all tracks. • Text information recorded on the Super Audio CD appears in the display.
OPTION	Switching the playback layer of the Super Audio CD



■ Switching the display

Press INFO.

Displays text and time information stored on media.

- The text information is only displayed for Super Audio CD.
- Any characters that cannot be displayed are replaced with “.” (period).

■ Discs that can be played back

- See “Playing back Discs” (📖 p. 74).

■ Playing a specific track (Direct searching)

1 Use 0 – 9 to select the tracks.

[Example]

Track 4 :

Press number 4 to select track 4.

Track 12 :

Press numbers 1 and 2 consecutively to select track 12.

- The number you enter is set about 1.5 seconds after you press the number buttons. To enter a two-digit number, be sure to press the two number buttons, one immediately after the other.



Setting the top priority playback layer for Super Audio CDs

The layer that is played with priority when the disc is loaded can be set.

1 Press CD to switch the input source to “CD”.

2 Check that no disc is loaded.

- If the layer is switched while the disc is being loaded, the playback layer switches for that disc, but the top priority playback layer setting itself does not change.

3 Press OPTION and switch to the layer you want to set.

STEREO (Default):	Plays back the 2-channel area of the Super Audio CD.
MULTI:	Plays back the multi-channel area of the Super Audio CD. The analog output of this unit outputs a down-mixed 2-channel signal.
CD:	Plays back the CD layer of the Super Audio CD.



- When a disc is loaded after the setting has been made, the contents recorded on the set layer are displayed.
- If a disc that does not contain the layer set for top priority playback is loaded, the contents recorded on another layer are displayed automatically.
- This setting is stored in the memory and is not cleared even when the disc holder is opened or closed or the power is turned off. To change the setting, repeat the procedure above.
- The priority playback layer cannot be set when a disc is inserted or “Open” is shown on the display.
- If the area and layer have not been set for a disc, the priority playback order is as follows:
 - ① STEREO
 - ② MULTI
 - ③ CD



Playing Data CDs and Data DVDs

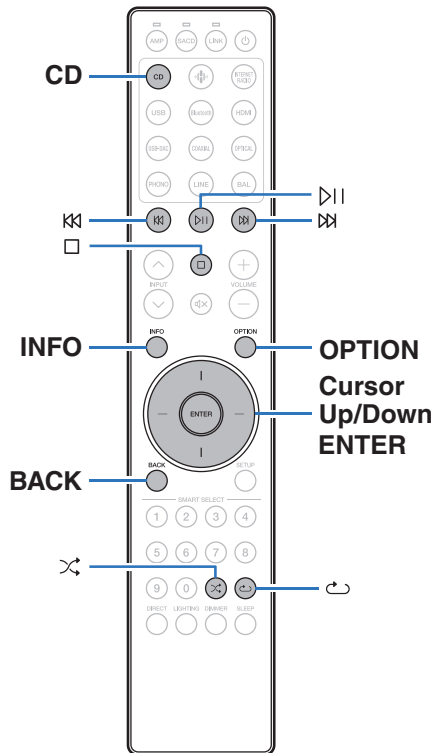

- This section explains how to playback music files that are recorded onto a CD-R/-RW or DVD-R/-RW/+R/+RW.
- There are many music distribution sites on the Internet allowing you to download music files. The music (files) downloaded from such sites can be stored on CD-R/-RW or DVD-R/-RW/+R/+RW discs and played on this unit.
- The audio format types and specifications supported by this unit for playback are as follows.
See “Playable files” for details. (p. 75)

- **MP3**
- **WMA**
- **AAC**
- **WAV**
- **FLAC**
- **Apple Lossless**
- **AIFF**
- **DSD**

NOTE







- Copyright-protected files cannot be played.
- Note that depending on the software used for burning and other conditions, some files may not play or display correctly.

“Windows Media” and “Windows” are the trademarks or registered trademarks of Microsoft Corporation in the United States and other countries.



Playing files

- 1 Press **CD** to switch the input source to “CD”.
- 2 Press \triangle on the main unit to insert a CD-R/-RW or DVD-R/-RW/+R/+RW disc containing music files.
- 3 Use **Cursor Up/Down** and **BACK** buttons to select the folder to be played, then press **ENTER**.
- 4 Use **Cursor Up/Down** buttons to select the file to be played, then press **ENTER**.
Playback starts.

Operation buttons	Function
	Playback / Pause
	Stop
	Skip to previous track / Skip to next track
	(Press and hold) Fast-reverse / Fast-forward
BACK	Moving up a level in the hierarchy
Cursor Up/Down	Select the item
ENTER	Enter the selected item / Playback
OPTION	Select the playback range
	Random playback
	Repeat playback <ul style="list-style-type: none"> • Switching between All-track repeat and Single-track repeat.
INFO	Switch the display between the album name and the file format



- To start playing another file during playback of a CD-R/-RW or DVD-R/-RW/+R/+RW, first press **BACK** to display the file tree. Next, use **Cursor Up/Down** buttons to select the file to be played and press **ENTER**.



■ Switching the display

During playback, press INFO.

- Switch the display between the album name and the file format.
- If a file does not support text information or no track information is recorded, the file name is displayed.
- Any characters that cannot be displayed are replaced with “.” (period).

■ Files that can be played back

- See “Playable files”. (📖 p. 75)

■ Switching the playback range

In the stop mode, press OPTION.

- The playback range of a track can be set.

Folder playback mode: All the files in the selected folder are played. 📁 is displayed on the display at this time.

All playback mode: All the files in the disc are played.



- The folder hierarchy is not displayed when “All playback mode” is set as the playback range.



Playing a USB flash drive

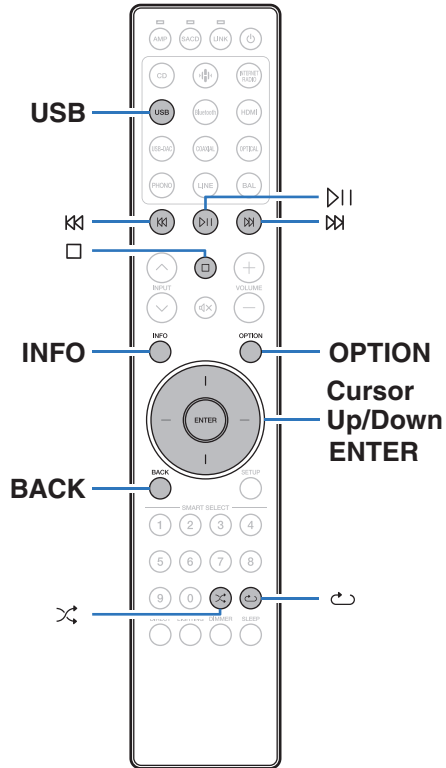

- Playing back music files stored on a USB flash drive.
- Only USB flash drives conforming to mass storage class standards can be played on this unit.
- This unit is compatible with USB flash drives in “FAT16” or “FAT32” format.
- The audio format types and specifications supported by this unit for playback are as follows.
For details, see “Playing back a USB flash drives” (👉 p. 77).

- **WMA**
- **MP3**
- **WAV**
- **MPEG-4 AAC**
- **FLAC**
- **Apple Lossless**
- **AIFF**
- **DSD**



Playing files stored on USB flash drives

1 Connect the USB flash drive to the USB port.
( p. 24)

2 Press **USB** to switch the input source to “USB”.



- When the setup menu's “Resume Play” ( p. 57) is on, playback starts automatically.

3 Press **BACK** button.

The file/folder list appears in the display of this unit.









- The file/folder list can also be displayed by pressing  to stop the playback.

4 Use **Cursor Up/Down** buttons to select the folder to be played, then press **ENTER**.

5 Use **Cursor Up/Down** buttons to select the file to be played, then press **ENTER**.

Playback starts.

Operation buttons	Function
	Playback / Pause
	Stop
	Skip to previous track / Skip to next track
	(Press and hold) Fast-reverse / Fast-forward
BACK	Moving up a level in the folder tree
Cursor Up/Down	Select the item
ENTER	Enter the selected item / Playback
OPTION	Select the playback range
	Random playback
	Repeat playback
	<ul style="list-style-type: none"> • Switching between All-track repeat and Single-track repeat.
INFO	Switch the display between the album name and the file format



- To start playing another file during playback of a USB flash drive, first press **BACK** to display the file tree. Next, use **Cursor Up/Down** buttons to select the file to be played and press **ENTER**.



NOTE

- Note that Marantz will accept no responsibility whatsoever for any problems arising with the data on a USB flash drive when using this unit in conjunction with the USB flash drive.
- When a USB flash drive is connected to this unit, the unit loads all of the files on the USB flash drive. Loading may take a while if the USB flash drive contains a large number of folders and/or files.

Switching the playback range

Press OPTION.

- The playback range of a track can be set.

Folder playback mode:	All the files in the selected folder are played.  is displayed on the display at this time.
All playback mode:	All the files in the USB flash drive are played.



Using as a D/A converter

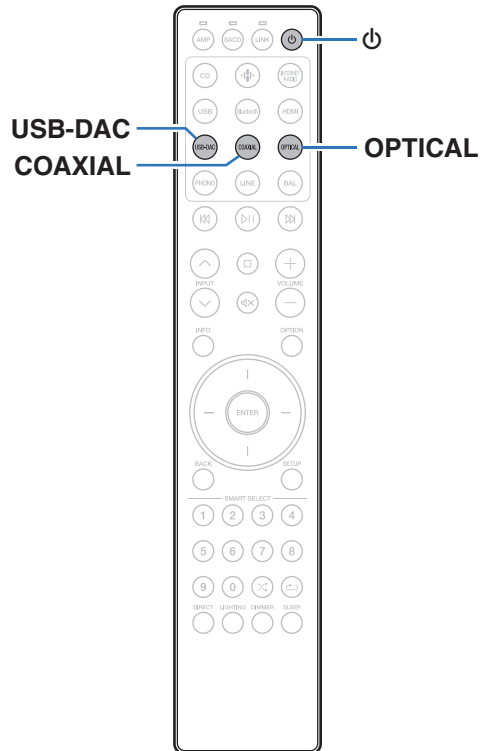

Digital audio signals input from an external device or computer into this unit can be converted and output as analog signals using this unit's D/A converter. (D/A converter function)

- DSD is a registered trademark.
- Microsoft, Windows 10 and Windows 11 are either registered trademarks or trademarks of Microsoft Corporation in the United States and/or other countries.
- ASIO is a trademark and software of Steinberg Media Technologies GmbH.
- Apple, Macintosh and macOS are trademarks of Apple Inc., registered in the U.S. and other countries.



Connecting and playing back from a computer (USB-DAC)

You can enjoy high-quality audio playback from the D/A converter built in to this unit by inputting music files into this unit from a computer via USB connection.

- Before USB connecting this unit to your computer, install the driver software in your computer.
- Drivers do not need to be installed for macOS.
- Also, you can use whichever commercially available or downloadable player software you like to playback files on your computer.

■ Computer (system requirements)

OS

- Windows 10 or Windows 11
- macOS 13 or 14

USB

- USB 2.0: USB High speed/USB Audio Class Ver. 2.0

NOTE

- This unit was checked the operation using the system requirements by us, but it does not guarantee the operation of all systems.

Windows OS

Installing the dedicated driver (🔗 p. 44)

macOS

Audio Device Settings (🔗 p. 50)

■ Installing the dedicated driver (Windows OS only)

□ Installing the driver software

- 1 Disconnect the USB cable between your PC and the unit.**
 - The driver software cannot be installed correctly if your PC is connected to the unit by a USB cable.
 - If the unit and your computer are connected by a USB cable and the computer is switched on before installation, disconnect the USB and restart the computer.
- 2 Download the dedicated driver from the “Download” section of the SACD 10 page of the Marantz website onto your PC.**
- 3 Unzip the downloaded file, and double-click the exe file.**



4 Install the driver.

- 1 Select the language to use for the installation.
- 2 Click “OK”.

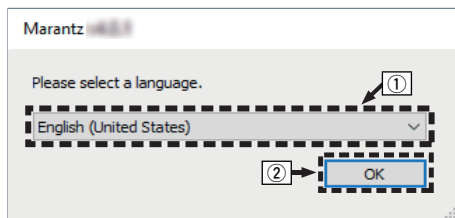

- 3 The wizard menu is displayed. Click “Next”.



- ④ Read the Software Licensing Agreement, and click “I accept the terms in the License Agreement.”.
- ⑤ Click “Next”.

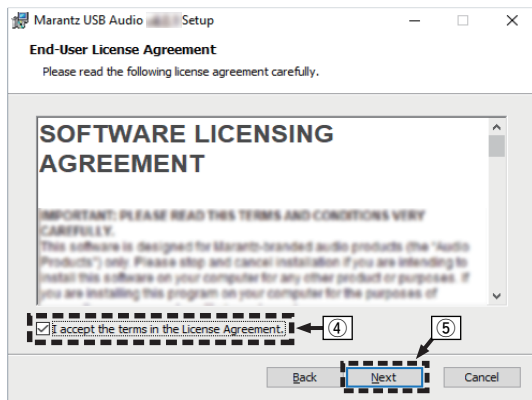

- ⑥ Select the installation destination and click “Next”.

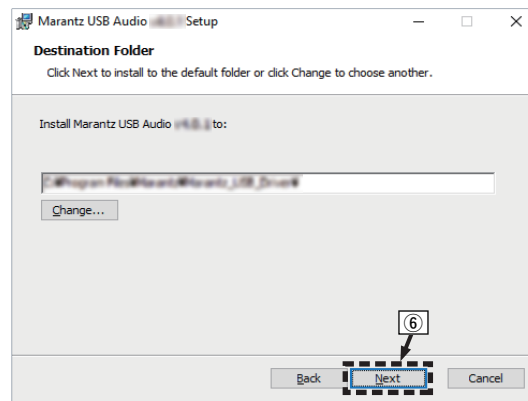

- ⑦ Click “Install” on the installation start dialog.
- The installation starts. Do not perform any operation on the PC until the installation is completed.

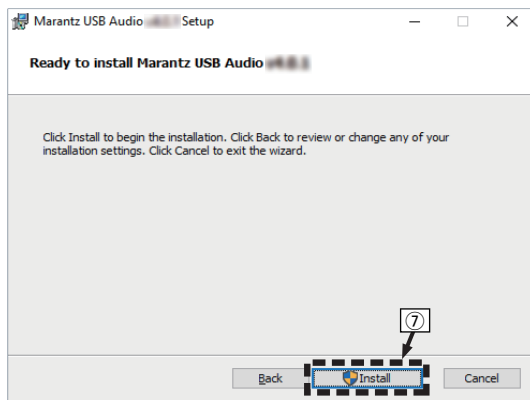

- ⑧ When the installation is completed, click “Finish”.

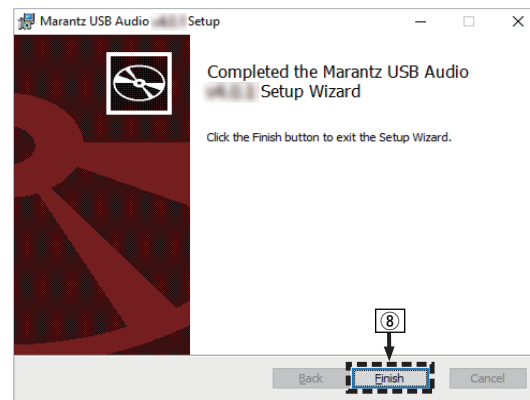

5 With the unit power off, connect the unit and PC using a USB cable (not included).

- For the connection procedure, refer to the “Connecting a PC or Mac” section. (📖 p. 23)



6 Press ϕ .

- When the unit power is turned on, the PC automatically finds and connects to the unit.

7 Press USB-DAC to switch the input source to “USB-DAC”.

8 Checking the installed driver.

- ① Open the “Control Panel” on the PC.
 - The control panel setting list is displayed.
- ② Click “Sound”.
 - The sound menu window is displayed.
- ③ Check that there is a checkmark next to “Default Device” under in “SACD 10” of the “Playback” tab.
 - When there is a checkmark for a different device, click “SACD 10” and “Set Default”.

9 Checking audio output.

Outputs a TEST signal from the PC and checks the audio output from the USB-DAC function.

- ① Select “SACD 10” and click “Properties”.
 - The Properties window is displayed.

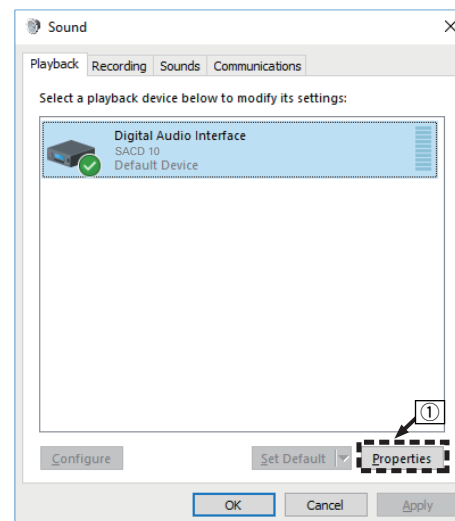

- ② Click the “Advanced” tab.
 - ③ Select the sampling rate and bit rate to be applied to the D/A converter.
 - It is recommended that “2 channel, 32 bit, 192000 Hz (Studio Quality)” is selected.
 - ④ Click “Apply”.
 - ⑤ Click “Test”.
- Check that audio from this unit is output from the PC.

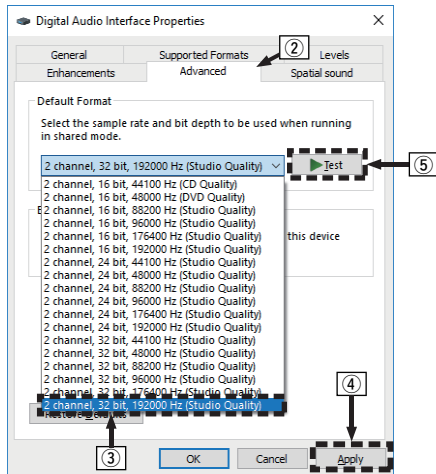

NOTE

- The dedicated driver must be installed in the PC before this unit is connected to a PC. Operation will not occur correctly if connected to the PC before the dedicated driver has been installed.
- Player software supporting the Audio Stream Input Output (ASIO) driver is required to play files with a sampling frequency of 352.8 kHz/384 kHz without downsampling. Check your player software before playing files with the ASIO driver.
- Operation may fail in some PC hardware and software configurations.
- Please see the FAQ at www.marantz.com if you experience any issues getting audio to play from your computer through the this unit. You may also want to check the support pages for your audio player application.



■ Audio device settings (macOS only)

- ① With the unit power off, connect the unit and Mac using a USB cable (not included).
 - For the connection procedure, refer to the “Connecting a PC or Mac” section. (👉 p. 23)
- ② Press ϕ .
- ③ Press USB-DAC to switch the input source to “USB-DAC”.
- ④ Move the cursor to “Go” on the computer screen, and then click “Utilities”.
 - The utility list is displayed.
- ⑤ Double-click “Audio MIDI Setup”.
 - The “Audio Devices” window is displayed.
- ⑥ Secondary click on “SACD 10”, and then check that “Use This Device For Sound Output” is checked.
 - If a different device is checked, select and “secondary click” on “SACD 10”, and then select “Use This Device For Sound Output”.

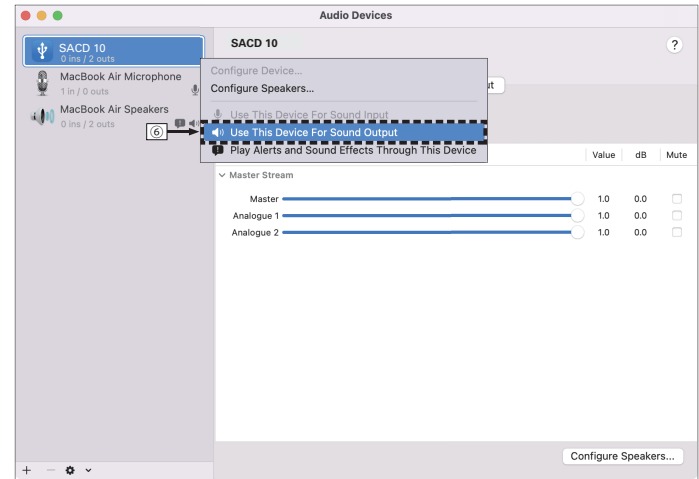

- ⑦ Select the “SACD 10” format.
- It is normally recommended to set the format to “2 ch 32-bit Integer 384.0 kHz”.

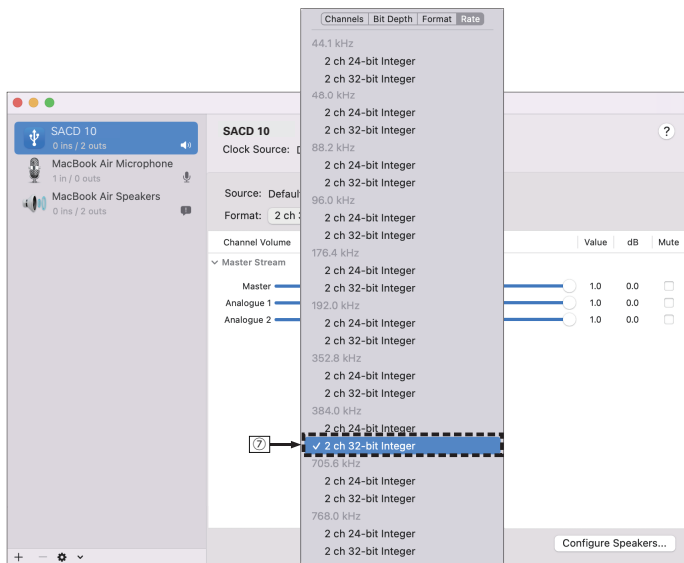

- ⑧ Quit Audio MIDI Setup.

■ Playback

Install the desired player software on your computer beforehand.
Use the rear panel USB-DAC port to connect this unit to a computer.
(p. 23)

1 Press USB-DAC to switch the input source to “USB-DAC”.

Start playback on the computer’s player software.

- If the sampling frequency cannot be detected, “Signal Unlock” will be displayed.
- “Unsupported” is displayed when audio signals that are not supported by this unit are input.

■ Specifications of supported audio formats

See “Digital input” (p. 82).



NOTE

- Perform operations such as playback and pause on the computer. At this time, you cannot perform operations with buttons on this unit or the remote control.
- When this unit is functioning as a D/A converter, sound is not output from the computer's speakers.
- If the computer is disconnected from this unit while the computer music playback software is running, the playback software may freeze. Always exit the playback software before disconnecting the computer.
- When an error occurs on the computer, disconnect the USB cable and restart the computer.
- The sampling frequency of the music playback software and sampling frequency displayed on this unit may differ.
- Use a cable that is 10 ft (3 m) or less to connect to the computer.

Connecting and playing back from a digital device (Coaxial/Optical 1/Optical 2)

- 1 Connect digital device to this unit.** (🔧 p. 22)
- 2 Press COAXIAL or OPTICAL to switch the input source to “Coaxial”, “Optical 1” or “Optical 2”.**
 - Pressing OPTICAL changes the input source to “Optical 1” or “Optical 2”.
- 3 Play the component connected to this unit.**
 - If the sampling frequency cannot be detected, “Signal Unlock” will be displayed.
 - “Unsupported” is displayed when audio signals that are not supported by this unit are input.

■ Specifications of supported audio formats

See “Digital input” (🔧 p. 82).

NOTE

- Do not input non-PCM signals, such as Dolby Digital, DTS and AAC. This causes noise and could damage the speakers.



Menu map

For menu operations, see the following page.

By default, this unit has recommended settings defined. You can customize this unit based on your existing system and your preferences.

Setting items	Detailed items	Description	Page
Audio	Filter	This unit is equipped with a sound quality adjusting function which allows users to enjoy the desired playback sound quality.	55
	Dither	This function adds audio data to minimize quantization error. Audio data to be added can be set on this unit. The sound quality changes. Set as desired.	55
	Noise Shaper	Improves linearity and noise characteristics in the audible range using digital feedback. The measurements are the same but the sound quality changes. Set as desired.	56
	Digital Out	Stopping digital audio output reduces a source of noise that affects sound quality, enabling higher sound quality playback.	56
	HP Amplifier Gain	Set the gain of the headphone amplifier.	57
	Resume Play	When the input source is switched, the USB flash drive is disconnected and then connected, or the power is turned off and then back on during USB flash drive playback, the unit memorizes the point where playback stopped so that playback can resume from the beginning of that track.	57
General	Illumination	This function adjusts the illumination of the front panel and the brightness of the display. It also enables linkage of the front panel illumination to the brightness of the display. When the brightness is turned "Off", the noise source affecting the sound quality is suppressed, and high-quality sound playback is possible.	58
	Auto-Standby	Sets whether to automatically switch the unit to the standby mode when there is no audio input and no operations are performed for more than 15 minutes.	58



Menu operation

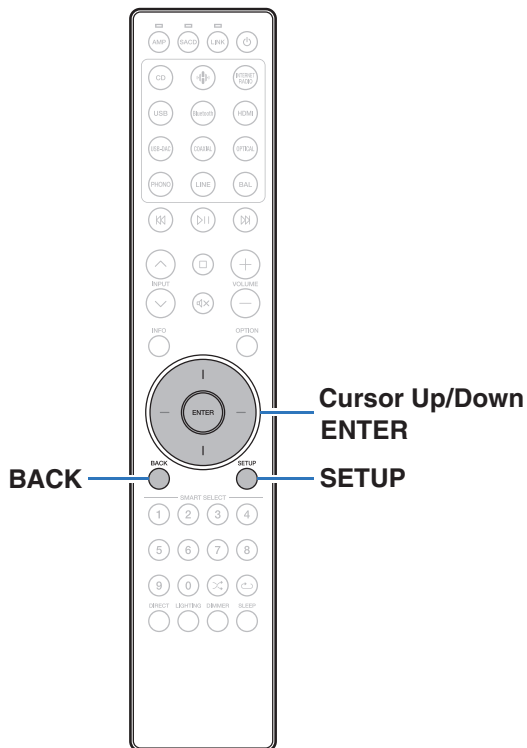

- 1 Press SETUP.**
The setup menu is displayed on the display.
- 2 Use Cursor Up/Down buttons to select the menu to be set or operated, then press ENTER.**
- 3 Use Cursor Up/Down buttons to change to desired setting.**
- 4 Press ENTER to enter the setting.**
 - To return to the previous item, press BACK.
 - Exiting the Menu, press SETUP while the setup menu is displayed. The display returns to the normal display.



Audio

Filter

This unit is equipped with a sound quality adjusting function which allows users to enjoy the desired playback sound quality. The unit supports PCM signal.

Filter 1 (Default):

Offers a short impulse response for both pre-echo and post-echo. Large amount of audio information clearly reproduces deep stereo imaging and the relative position of the sound source.

Filter 2:

This characteristic is known as asymmetrical impulse response. The post echo is slightly longer than the pre-echo. The sound characteristics is more analog like.

Dither

Dither is used to avoid artifacts of digital signal processing. Side effect of dither is that Signal/Noise ratio is slightly reduced or artifacts do not completely disappear. Set as desired.

Dither 1 (Default):

This is a Marantz developed dither that reduces digital artifacts while reducing SNR only very little.

Dither 2:

Classic dither that reduces all artifacts but also reduces SNR.

Off:

Highest SNR but digital artifacts may slightly influence soundstage or colorate the sound.

NOTE

- The Dither function does not work when playing a Super Audio CD or DSD audio source.



Noise Shaper

Improves linearity and noise characteristics in the audible range using digital feedback. The following degrees and methods can be set. The measurements are the same but the sound quality changes. Set as desired.

Balanced (Default):	This is the best compromise between highest signal to noise ratio and most open and detailed sound stage.
Natural:	This gives high SNR for natural instruments but may reduce some resolution.
Dynamic Music:	This improves the SNR but this cost resolution in sound stage. Highest possible dynamics for wideband music content in this setting.
Dynamic Voice:	Even higher SNR but only up to 5 kHz. This gives highest possible dynamics for natural instruments and voices.

NOTE

- The Noise Shaper function does not work when playing a Super Audio CD or DSD audio source.

Digital Out

Stopping digital audio output reduces a source of noise that affects sound quality, enabling higher sound quality playback.

On (Default):	Use the digital audio output connector.
Off:	Do not use the digital audio output connector.



HP Amplifier Gain

Set the gain of the headphone amplifier. Set this according to the impedance of the connected headphones. It is recommended that this is set on the “Low” side if the headphones have low impedance and on the “High” side if they have high impedance.

High:	Set the gain of the headphone amplifier to “High”. Set this if the volume is too low at the factory default setting.
Mid (Default):	Set the gain of the headphone amplifier to “Mid”.
Low:	Set the gain of the headphone amplifier to “Low”. Set this if the volume is too high at the factory default setting.

NOTE

- The headphone volume varies depending on the “HP Amplifier Gain” setting. Decrease the volume or mute the audio first if changing this setting while listening to audio.

Resume Play

When the input source is switched, the USB flash drive is disconnected and then connected, or the power is turned off and then back on during USB flash drive playback, the unit memorizes the point where playback stopped (resume information) so that playback can resume from after that point.

On (Default):	Resume playback is set.
Off:	Resume playback is not set.

NOTE

- Resume playback works even if the USB flash drive is disconnected and then reconnected. However, if a different USB flash drive is connected, the resume information for the previous USB flash drive is deleted.
- The resume information may be deleted when the USB flash drive is removed and files are added or deleted.
- Press  while playback is stopped to delete the resume information. “Resume Off” is displayed.



General

Illumination

This function adjusts the illumination of the front panel and the brightness of the display. It also enables linkage of the front panel illumination to the brightness of the display. When the brightness is turned "Off", the noise source affecting the sound quality is suppressed, and high-quality sound playback is possible.

■ Display

100 – 5 (Default: 100)

Off



- The display brightness setting is synchronized with the Dimmer menu setting. (🔗 p. 31)

■ Front Panel

Sync (Default): The brightness of the illumination is linked to the brightness of the display.

100 – 5

Off

Auto-Standby

Sets whether to automatically switch the unit to the standby mode when the unit remains in the stop mode for more than 15 minutes.

Off (Default): Disable Auto Standby mode.

On: Enable Auto Standby mode.



Disabling amplifier/streaming preamplifier operating mode on remote control

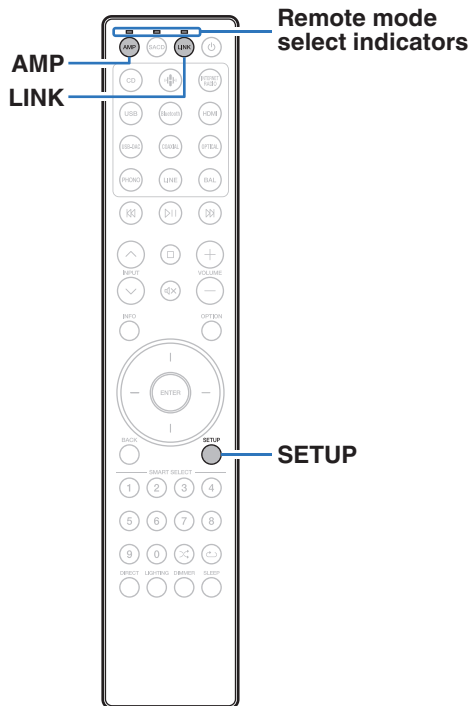

If you do not want to use this unit in combination with MODEL 10 or LINK 10n, you can disable the remote control operating mode of the device that you are not using. By default, all remote control operating modes are enabled.



- When remote control operating mode is enabled, be sure to check the operation of your device.



Disabling amplifier operating mode

- 1 Press and hold AMP and SETUP simultaneously until the remote mode select indicators flash green.**
 - Each time you perform Step 1, the amplifier operating mode is toggled between enabled/disabled.

Disabling streaming preamplifier operating mode

- 1 Press and hold LINK and SETUP simultaneously until the remote mode select indicators flash green.**
 - Each time you perform Step 1, the streaming preamplifier operating mode is toggled between enabled/disabled.



Setting the device to be operated by the volume buttons on the remote control

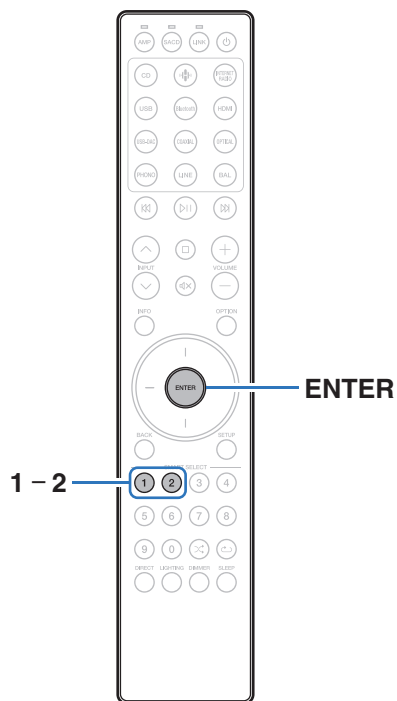

If you use this unit in combination with a Marantz amplifier or streaming preamplifier, you can specify the device to be operated by the volume buttons so that you can adjust the volume of the Marantz amplifier or streaming preamplifier while the included remote control remains in SACD player operating mode.



- After setting the device to be operated by the volume buttons on the remote control, be sure to check the operation of your device.
- Switching the device to be operated affects the VOLUME + and VOLUME - buttons on the remote control.



Setting the device to be operated by the volume buttons in SACD player operating mode

If you use a Marantz amplifier or streaming preamplifier in combination with this unit, you can switch the device to be operated by the volume buttons while the included remote control is set to SACD player operating mode.

By default, the device to be operated is set to “Amplifier”.

■ Set the device to be operated by the volume buttons to the amplifier

1 Press and hold ENTER and 1 on the remote control simultaneously for 5 seconds or more.

The AMP indicator will flash green.

■ Set the device to be operated by the volume buttons to the streaming preamplifier

1 Press and hold ENTER and 2 on the remote control simultaneously for 5 seconds or more.

The LINK indicator will flash green.



■ Contents

Tips

I want to switch the filter to change the desired sound quality	64
I want to enjoy analog output audio at higher quality	64
I want to display Super Audio CD text	64
I want to play the multi-channel area of a Super Audio CD is played	64
I want to playback just the specified folder	64
I want to randomly play back all tracks on a DVD-R/-RW/+R/+RW or CD-R/-RW	64
I want to playback high resolution music files	64
I want to stop the USB flash drive from automatically starting playback	65
Simple operations in the power off state	65
I want to operate a Marantz amplifier and streaming preamplifier using the remote control of this unit	65

Troubleshooting

Power does not turn on / Power is turned off	67
Operations cannot be performed through the remote control unit	68
Display on this unit shows nothing	69
No sound comes out	69
Sound is interrupted or noise occurs	70
Desired sound does not come out	70
USB flash drives cannot be played back	71
Cannot playback Discs	72
There is a delay before the disc tray starts to open	72
Music files on PC or Mac cannot be played back (USB-DAC)	73
Audio from digital devices cannot be played back (Coaxial/Optical)	73



Tips

I want to switch the filter to change the desired sound quality

- Switch the filter characteristics. (👉 p. 55)

I want to enjoy analog output audio at higher quality

- Set “Digital Out” on the setup menu to “Off”. (👉 p. 56)
- Press the DIMMER button to turn the display off. (👉 p. 31)
- Press the LIGHTING button to turn the display and lighting LED on the front panel off. (👉 p. 32)

I want to display Super Audio CD text

- This unit supports Super Audio CD text. Press the INFO button to switch the display information. (👉 p. 33)

I want to play the multi-channel area of a Super Audio CD is played

- This unit can play multi-channel audio by downmixing to two channels. Press the OPTION button and set “MULTI”. (👉 p. 36)

I want to playback just the specified folder

- Press the OPTION button to set the playback mode to folder playback mode. (👉 p. 39)

I want to randomly play back all tracks on a DVD-R/-RW/+R/+RW or CD-R/-RW

- Before playback, press the OPTION button to set the playback mode to “All playback mode”, then press the ⌘ button for random playback. (👉 p. 39)

I want to playback high resolution music files

- This unit can playback high resolution music files that are stored on a USB flash drive. (👉 p. 77)



I want to stop the USB flash drive from automatically starting playback

- Set “Off” to the “Resume Play”. (🔍 p. 57)

Simple operations in the power off state

- Press the ⏮ button to automatically turn the unit’s power supply on and start playback of the last selected input source.

I want to operate a Marantz amplifier and streaming preamplifier using the remote control of this unit

- Marantz amplifier and streaming preamplifier can also be operated with the remote control of this unit. Also refer to the amplifier and streaming preamplifier instruction manuals for those players. (🔍 p. 15)



Troubleshooting

If a problem should arise, first check the following:

1. Are the connections correct?
2. Is the set being operated as described in the owner's manual?
3. Are the other devices operating properly?



- If steps 1 to 3 above do not improve the problem, restarting the device may improve the problem.
Continue pressing the  button on the unit until "Restart" appears in the display, or remove and re-insert the power cord of the unit.

If this unit does not operate properly, check the corresponding symptoms in this section.

If the symptoms do not match any of those described here, consult your dealer as it could be due to a fault in this unit. In this case, disconnect the power immediately and contact the store where you purchased this unit.



Power does not turn on / Power is turned off

Power is not turned on.

- Check whether the power plug is correctly inserted into the power outlet. (👉 p. 28)
- This unit is in standby mode. Press the ⏻ button on the main unit or the ⏻ button on the remote control. (👉 p. 30)

Power automatically turns off.

- The auto standby mode setting is on. The auto standby mode automatically switches the unit to standby if there are no operations for more than 15 minutes. To disable the Auto Standby mode, set "Auto-Standby" on the menu to "Off". (👉 p. 58)

When the power is turned on, the power indicator flashes in orange.

- The protection circuit has been activated due to an error in the internal power supply. Unplug the power cord and contact our customer service center.



Operations cannot be performed through the remote control unit

Operations cannot be performed through the remote control unit.

- Batteries are worn out. Replace with new batteries. (👉 p. 6)
- Operate the remote control unit within a distance of about 23 ft/7 m from this unit and at an angle of within 30°. (👉 p. 6)
- Remove any obstacle between this unit and the remote control unit.
- Insert the batteries in the proper direction, checking the ⊕ and ⊖ marks. (👉 p. 6)
- The unit's remote control sensor is exposed to strong light (direct sunlight, inverter type fluorescent bulb light, etc.). Move the set to a place in which the remote control sensor will not be exposed to strong light.
- When using a 3D video device, the remote control unit of this unit may not function due to effects of infrared communications between units (such as TV and glasses for 3D viewing). In this case, adjust the direction of units with the 3D communications function and their distance to ensure they do not affect operations from the remote control unit of this unit.
- Press the SACD button to switch the remote control operating mode to SACD player operating mode. (👉 p. 12)
- Remote control SACD player operating mode is disabled. Press and hold the SACD and SETUP buttons simultaneously for 3 seconds or more to enable SACD player operating mode.
- The device to be operated by the VOLUME + and 🔊 buttons is a Marantz streaming preamplifier. If the remote control is set to SACD player operation mode and the volume of the Marantz amplifier connected to this unit cannot be adjusted, switch the operating device to the amplifier. (👉 p. 61)
- The device to be operated by the VOLUME + and 🔊 buttons is a Marantz amplifier. If the remote control is set to SACD player operation mode and the volume of the Marantz streaming preamplifier connected to this unit cannot be adjusted, switch the operating device to the streaming preamplifier. (👉 p. 61)
- When using this unit independently, set the switch to "INTERNAL". (👉 p. 26)



Display on this unit shows nothing

Display is off.

- Press the DIMMER button, and change the setting to anything other than off. (👉 p. 31)
- Set “Illumination” - “Display” on the setup menu to something other than “Off”. (👉 p. 58)
- Press the LIGHTING button to turn on the lighting. (👉 p. 32)

No sound comes out

No sound is produced. Or sound is distorted.

- Check the connections for all devices. (👉 p. 18)
- Insert connection cables all the way in.
- Check that input connectors and output connectors are not reversely connected.
- Check cables for damage.
- Check the amplifier's functions and controls and adjust as necessary.
- When connecting to a device with digital audio input connectors, set “Digital Out” to “On”. (👉 p. 56)
- Digital audio output stops when playing the HD layer of a Super Audio CD or a file with a DSD signal or a linear PCM signal with a sampling frequency of 352.8 kHz or higher.



Sound is interrupted or noise occurs

During playback from the CD-R/-RW or DVD-R/-RW/+R/+RW, sound is occasionally interrupted.

- The sound may skip during playback of a CD-R/-RW containing a high-resolution audio source.
- This may be caused by poor recording conditions, or the disc itself may be of poor quality. Use a correctly recorded disc.

During playback from the USB flash drive, sound is occasionally interrupted.

- When the transfer speed of the USB flash drive is slow, sound may occasionally be interrupted.

Sound is interrupted during playback of tracks saved on a computer.

- Do not start applications other than the player software while playing music on your computer.
- The sound may be interrupted depending on the hardware or software configuration of the computer being used.

Desired sound does not come out

Headphone volume is low.

- Switch “HP Amplifier Gain” to “High” if using headphones with high impedance or low sensitivity. “HP Amplifier Gain” (🔍 p. 57)



USB flash drives cannot be played back

USB flash drive is not recognized.

- Disconnect and reconnect the USB flash drive. (👉 p. 24)
- Mass storage class compatible USB flash drives are supported.
- This unit does not support a connection through a USB hub. Connect the USB flash drive directly to the USB port.
- The USB flash drive must be formatted to FAT16 or FAT32.
- Not all USB flash drives are guaranteed to work. Some USB flash drives are not recognized. When using a type of portable hard disc drive compatible with the USB connection that requires power from an AC adapter, use the AC adapter that came with the drive.

Files on the USB flash drive are not displayed.

- Files of a type not supported by this unit are not displayed. (👉 p. 77)
- This unit can display a file structure with up to 8 levels, up to 1,000 folders and up to 2,000 files in 1 folder. Modify the folder structure of the USB flash drive.
- When multiple partitions exist on the USB flash drive, only files on the first partition are displayed.

iOS and Android devices are not recognized.

- The USB port of this unit does not support playback from iOS and Android devices.

Files on a USB flash drive cannot be played.

- Files are created in a format that is not supported by this unit. Check the formats supported by this unit. (👉 p. 77)
- You are attempting to play a file that is copyright protected. Files that are copyright protected cannot be played on this unit.
- Playback may not be possible if the album art file size exceeds 2 MB.



Cannot playback Discs

Cannot playback when the play button is pressed, or cannot correctly playback a specific part of the disc.

- The disc is dirty or scratched. Either clean the disc, or insert a different disc. (👉 p. 81)

Cannot playback CD-R/-RW or DVD-R/-RW/+R/+RW.

- Discs cannot be played back unless they have been finalized. Use a finalized disc. (👉 p. 74)
- This may be caused by poor recording conditions, or the disc itself may be of poor quality. Use a correctly recorded disc.
- Files are created in a format that is not supported by this unit. Check the formats supported by this unit. (👉 p. 75)

“No Disc” is displayed.

- “No Disc” is displayed if the disc is loaded upside-down, if no disc is loaded, when the inserted disc cannot be read because it is not compatible with this unit or is dirty or scratched.

“System Error” is displayed.

- “System Error” is displayed when an error not caused by disc, format, etc., occurs. Contact our customer service center.

“Wrong Format” is displayed.

- “Wrong Format” is displayed for files created in a format that is not supported by this unit. Check the formats supported by this unit. (👉 p. 75)

There is a delay before the disc tray starts to open

There is a delay before the disc tray starts to open.

- When an input source other than “CD” is selected, the power to the CD drive mechanism is turned off in order to improve the sound quality. This occurs because the power to the mechanism is turned off, it is not a malfunction.



Music files on PC or Mac cannot be played back (USB-DAC)

This unit is not recognized on the computer.

- Reconnect the USB cable to the USB port on your computer. When this unit is still not recognized after reconnection, connect to a different USB port. (👉 p. 23)
- Restart your computer.
- Check the OS of your computer. (👉 p. 44)
- When your computer is running on Windows, a dedicated driver software should be installed. (👉 p. 44)

This unit is not selected as the playback device.

- Select this unit as the playback device in the sound settings on the computer. (👉 p. 44)

“Signal Unlock” is displayed.

- When digital audio signals cannot be detected properly, “Signal Unlock” is displayed. (👉 p. 51)

“Unsupported” is displayed.

- “Unsupported” is displayed when audio signals that are not supported by this unit are input. Check the settings on your computer or player software. (👉 p. 51)
- If the computer you use is macOS, please check if the SACD 10 format is set below 384.0 kHz using the Audio MIDI Setup. (👉 p. 50)

Audio from digital devices cannot be played back (Coaxial/Optical)

“Signal Unlock” is displayed.





- When digital audio signals cannot be detected properly, “Signal Unlock” is displayed. (👉 p. 52)

“Unsupported” is displayed.

- “Unsupported” is displayed when audio signals that are not supported by this unit are input. Check the audio output signal format from your digital device. (👉 p. 52)



Playing back Discs

Playable media	
Super Audio CD	
CD	
CD-R	
CD-RW	
DVD-R/-RW/+R/+RW	

NOTE

- Some discs and some recording formats cannot be played.
- Non-finalized discs cannot be played.

■ Super Audio CD

There are three types of Super Audio CDs:

- ① Single layer disc
Single layer Super Audio CD with just an HD layer.
- ② Dual layer disc
Super Audio CD with two HD layers. Enables long playback at a high audio quality.
- ③ Hybrid disc
Two-layer Super Audio CD with an HD layer and a CD layer.
The signals on the CD layer can be played on a regular CD player.

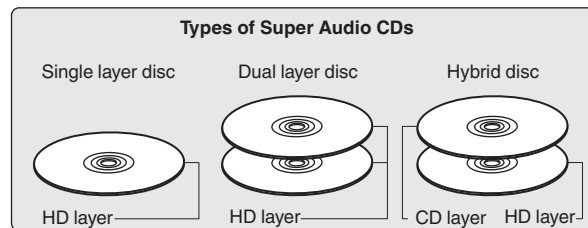

The HD layer is a layer of high density signals for Super Audio CDs. The CD layer is the layer of signals that can be read on a regular CD player.



- When "MULTI" is selected, down-mixed audio is output to the L and R channels.



■ Playable files

	Sampling frequency	Bit rate	Bit length	Playable discs			Extension
				CD-R/-RW	DVD-R/-RW	DVD+R/+RW	
MP3	44.1/48 kHz	32 – 320 kbps	-	✓	✓	✓	.mp3
WMA	44.1/48 kHz	48 – 320 kbps	-	✓	✓	✓	.wma
AAC	44.1/48 kHz	16 – 320 kbps	-	✓	✓	✓	.aac/ .m4a
WAV	44.1/48/88.2/ 96/176.4/192 kHz	-	16/24 bits	✓*2	✓	✓	.wav
FLAC	44.1/48/88.2/ 96/176.4/192 kHz	-	16/24 bits	✓*2	✓	✓	.flac
Apple Lossless*1	44.1/48/ 88.2/96 kHz	-	16/24 bits	✓*2	✓	✓	.m4a
AIFF	44.1/48/88.2/ 96/176.4/192 kHz	-	16/24 bits	✓*2	✓	✓	.aif/ .aiff
DSD	2.8/5.6 MHz	-	1 bit	-	✓	✓	.dsf/ .dff

*1 The Apple Lossless Audio Codec (ALAC) decoder is distributed under the Apache License, Version 2.0 (<http://www.apache.org/licenses/LICENSE-2.0>).

*2 This item can only be used to play files with a sampling frequency of 44.1/48 kHz.

■ Maximum number of playable files and folders

Maximum number of folders : 1,000

Maximum number of files in 1 folder : 2,000



NOTE

- Be sure to give files the extension. Files with any other extensions or files with no extensions cannot be played.
- Recordings you have made should only be used for your personal enjoyment, and as per copyright laws may not be used in other ways without permission of the copyright holder.



- Only music files that are not copyright-protected can be played on this unit.
 - Content downloaded from pay sites on the Internet are copyright protected. Also, files encoded in WMA format when ripped from a CD, etc. on a computer may be copyright protected, depending on the computer's settings.
- The maximum number of files and folders that can be played differs depending on conditions such as the length of the file name or folder name or the number of levels in the folder hierarchy.



Playing back a USB flash drives

■ USB-compatible file systems

FAT16 or FAT32

- If the USB memory device is divided into multiple partitions, only the top drive can be selected.

■ Maximum number of playable files and folders

Maximum number of folders : 1,000

Maximum number of files in 1 folder : 2,000

■ Tag data

ID3-TAG (Ver.1.x and 2.x)

WMA-TAG

(The title, artist, and album tag data are supported)



Compatible formats

	Sampling frequency	Bit rate	Bit length	Extension
MP3	44.1/48 kHz	32 – 320 kbps	–	.mp3
WMA	44.1/48 kHz	48 – 320 kbps	–	.wma
AAC	44.1/48 kHz	16 – 320 kbps	–	.aac/ .m4a
WAV	44.1/48/88.2/96/176.4/192 kHz	–	16/24 bits	.wav
FLAC	44.1/48/88.2/96/176.4/192 kHz	–	16/24 bits	.flac
Apple Lossless *	44.1/48/88.2/96/176.4/192 kHz	–	16/24 bits	.m4a
AIFF	44.1/48/88.2/96/176.4/192 kHz	–	16/24 bits	.aif/ .aiff
DSD	2.8/5.6 MHz	–	1 bit	.dsf/ .dff

* The Apple Lossless Audio Codec (ALAC) decoder is distributed under the Apache License, Version 2.0 (<http://www.apache.org/licenses/LICENSE-2.0>).

NOTE

- Be sure to give files the extension. Files with any other extensions or files with no extensions cannot be played.
- Recordings you have made should only be used for your personal enjoyment, and as per copyright laws may not be used in other ways without permission of the copyright holder.
- It is not compatible with an MP3 player, digital camera, a USB device for a mobile phone, etc.
- The unit does not support a card reader, USB extension cable, or USB hub.



- Only music files that are not copyright-protected can be played on this unit.
 - Content downloaded from pay sites on the Internet are copyright protected. Also, files encoded in WMA format when ripped from a CD, etc. on a computer may be copyright protected, depending on the computer's settings.
- The maximum number of files and folders that can be played differs depending on conditions such as the length of the file name or folder name or the number of levels in the folder hierarchy.



Playback order of music files

When there are multiple folders containing music files, the playback order of folders is automatically set when this unit reads the media. The files in each folder are played back in the order in which the files were recorded on the media, from the oldest date and time.

CD-R/-RW, DVD-R/-RW/+R/+RW and USB flash drive

For playback of files on CD-R/-RW, DVD-R/-RW/+R/+RW or USB flash drive, files in all folders on the first layer are played first, next on the second layer, then next on the third layer, and so on in this order.



- The playback order displayed on a PC may differ from the actual playback order.
- The playback order with a CD-R/-RW and DVD-R/-RW/+R/+RW may differ, depending on the writing software.
- The playback order may differ from the order in which the folders or files were recorded if you delete or add a folder or file on USB. This occurs because of data recording specifications and is not a malfunction.

About discs and files

Music files recorded on CD-R/-RW, DVD-R/-RW/+R/+RW and USB flash drive are divided into large segments (folders) and small segments (files). Files are stored in folders, and folders can be placed for storage in a hierarchy. The unit can recognize up to 8 levels of folders.

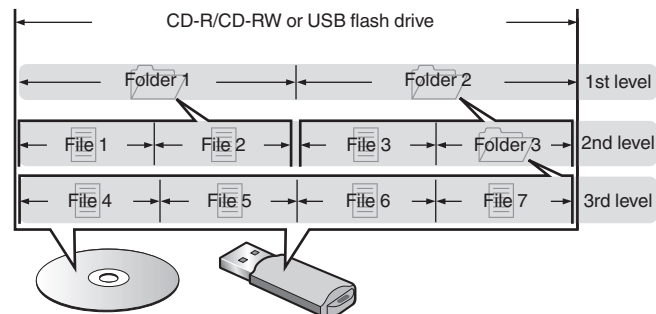

- When writing music files on a CD-R/-RW or DVD-R/-RW/+R/+RW disc, set the writing software's format to "ISO9660". The files may not play properly if they are recorded in other formats. For details, refer to the instructions of your writing software.



Cautions on using media

Loading discs

- Set the disc in the tray label side up.
- Make sure the disc tray is fully open when inserting the disc.
- Place the discs flatly, 5 inch/12 cm discs in the outer tray guide (Figure 1), 3 inch/8 cm discs in the inner tray guide (Figure 2).

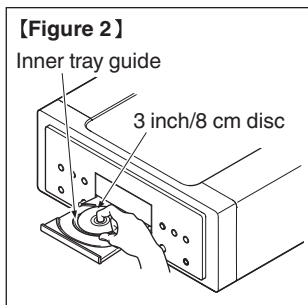
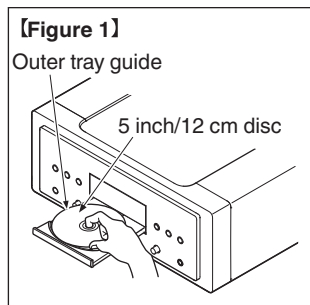

- Place 3 inch/8 cm discs in the inner tray guide without using an adapter.

NOTE

- Only load one disc at a time. Loading two or more discs can damage the unit or scratch the discs.
- Do not use cracked or warped discs or discs that have been repaired with adhesive, etc.
- Do not use discs on which the sticky part of cellophane tape or labels is exposed or on which there are traces of where labels have been removed. Such discs can get caught inside the player and damage it.
- Do not use discs in special shapes, as they may damage the unit.



- Do not push the disc tray in by hand when the power is off. Doing so could damage the unit.
- If the unit is left in a room full of smoke from cigarettes, etc., for long periods of time, the surface of the optical pickup may get dirty, preventing it from receiving signals properly.



How to handle media

- Do not get fingerprints, oil or dirt on discs.
- Take special care not to scratch discs when removing them from their cases.
- Do not bend or heat discs.
- Do not enlarge the hole in the center.
- Do not write on the labeled (printed) surface with ball-point pens, pencils, etc., or stick new labels on discs.
- Condensation may form on discs if they are moved suddenly from a cold place (outdoors for example) to a warm place, but do not try to dry discs with a hairdryer, etc.
- Do not eject a USB flash drive or turn off the unit while a USB flash drive is being played. This may result in malfunction or loss of the USB flash drive's data.
- Do not attempt to open or modify a USB flash drive.
- USB flash drive and files can be damaged by static electricity. Do not touch the metal contacts of a USB flash drive with your fingers.
- Do not use warped USB flash drive.
- After use, be sure to remove any disc or USB flash drive, and store it in its proper case, to avoid dust, scratches and deformation.
- Do not store discs in the following places:
 1. Places exposed to direct sunlight for long periods of time
 2. Dusty or humid places
 3. Places exposed to heat from heaters, etc.

Cleaning discs

- If there are fingerprints or dirt on a disc, wipe them off before using the disc.
- Use a commercially available disc cleaning set or a soft cloth to clean discs.



Gently wipe the disc from the inside towards the outside.

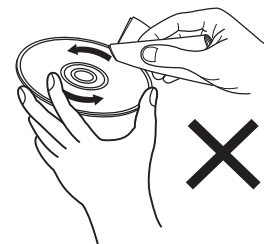

Do not wipe with a circular motion.

NOTE

- Do not use record spray, antistatic agents, benzene, thinner or other solvents.



Digital input

■ Specifications of supported audio formats

□ USB-DAC

	Sampling frequency	Bit length
DSD (2-channel)	2.8/5.6/ 11.2 MHz	1 bit
Linear PCM (2-channel)	44.1/48/88.2/96/ 176.4/192/352.8/ 384 kHz	16/24/32 bits



- Digital audio output stops during playback of the DSD files and linear PCM signals with a sampling frequency of 352.8/384 kHz.

□ Coaxial/Optical

	Sampling frequency	Bit length
Linear PCM (2-channel)	44.1/48/88.2/96/ 176.4/192 kHz	16/24 bits



Explanation of terms

AIFF (Audio Interchange File Format)

This is an uncompressed and lossless format for digital audio. Use AIFF files to burn high-quality audio CDs from imported songs. AIFF files use approximately 10 MB of disk space per minute.

Apple Lossless Audio Codec

This is a codec for lossless audio compression method developed by Apple Inc. This codec can be played back on iTunes, iPod or iPhone. Data compressed to approximately 60 – 70 % can be decompressed to exactly the same original data.

DSD (Direct-Stream Digital)

One of the audio data recording methods, it is the signal aspect used to store audio signals on a super audio CD, and is $\Delta-\Sigma$ modulated digital audio.

FLAC (Free Lossless Audio Codec)

FLAC stands for Free lossless Audio Codec, and is a lossless free audio file format. Lossless means that the audio is compressed without any loss in quality.

The FLAC license is as shown below.

Copyright (C) 2000, 2001, 2002, 2003, 2004, 2005, 2006, 2007, 2008, 2009 Josh Coalson

Redistribution and use in source and binary forms, with or without modification, are permitted provided that the following conditions are met:

- Redistributions of source code must retain the above copyright notice, this list of conditions and the following disclaimer.
- Redistributions in binary form must reproduce the above copyright notice, this list of conditions and the following disclaimer in the documentation and/or other materials provided with the distribution.
- Neither the name of the Xiph.org Foundation nor the names of its contributors may be used to endorse or promote products derived from this software without specific prior written permission.

THIS SOFTWARE IS PROVIDED BY THE COPYRIGHT HOLDERS AND CONTRIBUTORS "AS IS" AND ANY EXPRESS OR IMPLIED WARRANTIES, INCLUDING, BUT NOT LIMITED TO, THE IMPLIED WARRANTIES OF MERCHANTABILITY AND FITNESS FOR A PARTICULAR PURPOSE ARE DISCLAIMED. IN NO EVENT SHALL THE FOUNDATION OR CONTRIBUTORS BE LIABLE FOR ANY DIRECT, INDIRECT, INCIDENTAL, SPECIAL, EXEMPLARY, OR CONSEQUENTIAL DAMAGES (INCLUDING, BUT NOT LIMITED TO, PROCUREMENT OF SUBSTITUTE GOODS OR SERVICES; LOSS OF USE, DATA, OR PROFITS; OR BUSINESS INTERRUPTION) HOWEVER CAUSED AND ON ANY THEORY OF LIABILITY, WHETHER IN CONTRACT, STRICT LIABILITY, OR TORT (INCLUDING NEGLIGENCE OR OTHERWISE) ARISING IN ANY WAY OUT OF THE USE OF THIS SOFTWARE, EVEN IF ADVISED OF THE POSSIBILITY OF SUCH DAMAGE.



MP3 (MPEG Audio Layer-3)

This is an internationally standardized audio data compression scheme, using the “MPEG-1” video compression standard. It compresses the data volume to about one eleventh its original size while maintaining sound quality equivalent to a music CD.

MPEG (Moving Picture Experts Group), MPEG-2, MPEG-4

These are the names for digital compression format standards used for the encoding of video and audio. Video standards include “MPEG-1 Video”, “MPEG-2 Video”, “MPEG-4 Visual”, “MPEG-4 AVC”. Audio standards include “MPEG-1 Audio”, “MPEG-2 Audio”, “MPEG-4 AAC”.

WMA (Windows Media Audio)

This is audio compression technology developed by Microsoft Corporation.

WMA data can be encoded using Windows Media® Player.

To encode WMA files, only use applications authorized by Microsoft Corporation. If you use an unauthorized application, the file may not work properly.

Sampling frequency

Sampling involves taking a reading of a sound wave (analog signal) at regular intervals and expressing the height of the wave at each reading in digitized format (producing a digital signal).

The number of readings taken in one second is called the “sampling frequency”. The larger the value, the closer the reproduced sound is to the original.

Dynamic range

The difference between the maximum undistorted sound level and the minimum discernible level above the noise emitted by the device.

Downmix

This function converts the number of channels of surround audio to a lower number of channels and plays back according to the system’s configuration.

Bit rate

This is the amount of audio data recorded on a disc that is read in one second.

Finalizing

This process enables DVD/CD recorded with a recorder to be played by other players.

Linear PCM

This is an uncompressed PCM (Pulse Code Modulation) signal. Unlike lossy compression audio sources such as MP3, no audio quality or dynamic range deteriorates.

Protection circuit

This is a function to prevent damage to devices within the power supply when an abnormality such as an overload, excess voltage occurs or over temperature for any reason.



Specifications

■ Audio performance

• Analog output	[Super Audio CD]	[CD]
Channels:	2-channels	2-channels
Playable frequency range:	2 Hz – 100 kHz	2 Hz – 20 kHz
Playable frequency response:	2 Hz – 50 kHz (-3 dB)	2 Hz – 20 kHz (± 1 dB)
S/N:	118 dB (Audible range)	116 dB
Dynamic range:	112 dB (Audible range)	98 dB
Harmonic distortion:	0.0004 % (1 kHz, Audible range)	0.0015 % (1 kHz)
Wow & flutter:	Crystal accuracy	Crystal accuracy
• Output level		
Unbalanced:	2.5 V (10 k Ω /kohms)	2.0 V (10 k Ω /kohms)
Balanced:	5.0 V (10 k Ω /kohms)	4.0 V (10 k Ω /kohms)
Headphone output:	130 mW/32 Ω /ohms (variable maximum)	130 mW/32 Ω /ohms (variable maximum)
• Digital output		
Coaxial:	-	0.5 V _{p-p} / 75 Ω /ohms
Optical:	-	-19 dBm
• Optical readout system		
Laser:	AlGaAs	AlGaAs
Wave length:	650 nm	780 nm
Signal type:	1-bit DSD	16-bit linear PCM
Sampling frequency:	2.8224 MHz	44.1 kHz



■ General

Power supply:	AC 120 V, 60 Hz
Power consumption:	55 W
Power consumption in standby mode:	0.3 W or less
Operating temperature:	41 °F - 95 °F (5 °C - 35 °C)
Operating humidity:	5 – 90 % (without dew)

For the purpose of improvement, the specifications and design are subject to change without notice.



■ Dimensions (Unit : in. (mm))

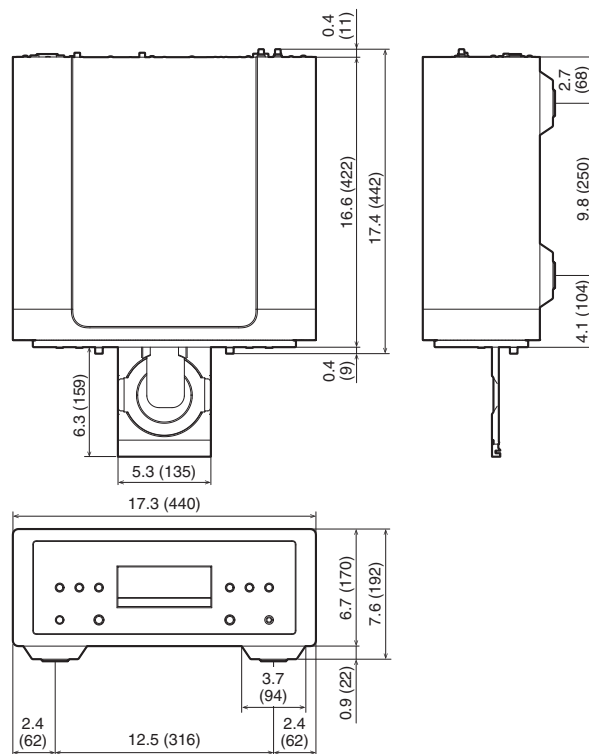

■ Weight : 72 lbs 12 oz (33.0 kg)



Index

A	
Amplifier	19, 21
Auto-Standby	58
C	
CD	33
D	
D/A converter	21
DATA CD	37
DATA DVD	37
Display's brightness	31
F	
Front panel	7
R	
Rear panel	10
Remote control unit	12
S	
Super Audio CD	33
T	
Tips	64
Troubleshooting	66
U	
USB flash drive	24, 40



marantz

3520 10986 00AS

© 2024 Masimo. All Rights Reserved.