

marantz®

Model PM-10 Owner's Manual

Integrated Amplifier

You can print more than one page of a PDF onto a single sheet of paper.

Contents

Accessories	2
About the remote control	2
Inserting the batteries	2
Operating range of the remote control unit	2
Features	3
High quality sound	3
High performance	3
Part names and functions	4
Front panel	4
Rear panel	5
Remote control unit	6
Connections	8
Connecting speakers	8
Speaker connection	9
Bi-wiring connection	9
Connecting a playback device	10
About balanced connectors	10
Connecting a recording device	10
F.C.B.S. connection	11
Preparation for F.C.B.S. connection	11
Stereo complete bi-amp connection	12
Connection for 5.1 Multi-channel Playback	14
Connecting a pre-amplifier	15
Connecting devices with remote control connectors	16
Performing operations by RC on this unit without visual contact	16
Remotely connecting Marantz audio devices	16
Connecting the power cord	16

Playback	17
Turning the power on	17
Selecting the input source	17
Adjusting the volume	17
Turning off the sound temporarily (Muting)	18
Adjusting the left and right channel balance	18
Having the display and the illumination lamp off	18
Having the illumination lamp always off	18
Playing CDs	19
Recording	19

Settings	20
Menu map	20
Menu operation	20
PUREST	21
PHONO	21
AUTO STBY (Auto Standby)	21





Tips	22
Tips	23
Troubleshooting	24

Appendix	27
Explanation of terms	27
Trademark information	27
Specifications	28
Index	30

Thank you for purchasing this Marantz product. To ensure proper operation, please read this owner's manual carefully before using the product. After reading this manual, be sure to keep it for future reference.

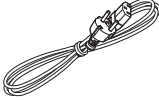
Accessories

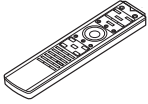
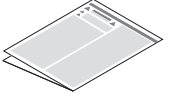
Check that the following parts are supplied with the product.

 <p>Quick Start Guide</p>	 <p>Power cord</p>
 <p>CD-ROM (Owner's Manual)</p>	 <p>Remote control unit (RC004PMSA)</p>
 <p>Safety Instructions</p>	 <p>R03/AAA batteries</p>

About the remote control

Inserting the batteries

1 Remove the rear lid in the direction of the arrow and remove it.

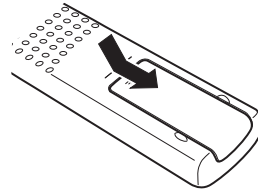

2 Insert two batteries correctly into the battery compartment as indicated.

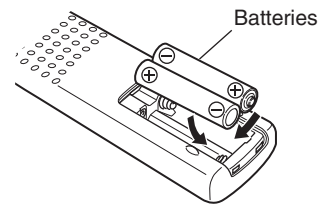

3 Put the rear cover back on.

NOTE

- To prevent damage or leakage of battery fluid:
 - Do not use a new battery together with an old one.
 - Do not use two different types of batteries.
- Remove the batteries from the remote control unit if it will not be in use for long periods.
- If the battery fluid should leak, carefully wipe the fluid off the inside of the battery compartment and insert new batteries.

Operating range of the remote control unit

Point the remote control unit at the remote sensor when operating it.

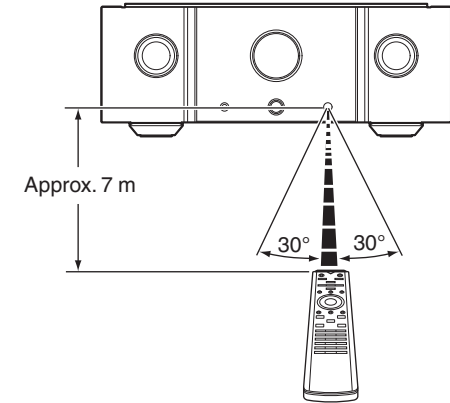

Features

High quality sound

- **HDAM®SA3 Module**

This unit includes the HDAM®SA3 which had been developed for high-end models. The HDAM®SA3 is incorporated into many components, such as the current feedback phono equalizer.

- **All-stage Balanced Configuration Amplifier Circuit**

This unit has an all-stage balanced configuration and the power amplifier receives output via a BTL (Bridged Transless) connection. Both the positive and negative terminals of the speakers are directly driven by the output stage of the power amplifier to exhibit a high drive capacity. Furthermore, since the drive current of the speakers does not flow directly into the ground circuit, the voltage that serves as the basis of the amplification is stabilized, reducing noise and interference between circuits, so that amplification is conducted accurately.

- **Linear Control Volume**

The control knob had adopted the high-end model design concept. For better S/N ratio, the MAS6116 from Micro Analog Systems and the HDAM®SA3 have been combined, which enables smooth adjustment in the range of 0 to -100 dB in units of ±0.5 dB.

- **Hypex Switching Power Amplifier Module**

The power amplifier uses a total of 4 Hypex NCore® switching power amplifier modules with BTL connections. The switching amplifier modules exhibit extremely excellent performance with minimal distortion from low to high frequency and no frequency response change regardless of speaker impedance. Combined use with a high-speed pre amplifier circuit using HDAM®SA3 faithfully and precisely reproduces the detailed information in DSD and high-resolution sound sources.

- **Dual-Amplifier Structure**

Amplifier of this unit has dual structure, pre amplifier and power buffer, adopting high-end model design concept. This dual structure enables the power buffer amplifier to drive the speakers powerfully, preventing influence from the back electromagnetic force from the speakers. The pre amplifier drives the power buffer with super-low distortion.

- **Constant Current Feedback Phono Equalizer**

This unit incorporates the constant current feedback phono equalizer which had been developed for high-end models. This equalizer, developed by Marantz, has the advantages of both NF-type and CR-type phono equalizers, and it supports both MM and MC cartridges. The PHONO input terminal is also equipped with an input impedance switch. In addition to cartridges with medium to high impedance, it provides the optimal impedance for cartridges with low impedances of about 2 to 10 Ω/ohms which are representative of high-end brand cartridges.

- **High Sound Quality Parts Employed**

High sound quality parts are used in every part of the circuit, including newly adopted high sound quality MELF resistors and film capacitors.

- **Display**

This unit adopts an LCD (Liquid Crystal Display) to display the input source and volume level. Compared with other types of display panels, an LCD requires less drive power and generates less radiation noise, which minimizes any adverse effect on sound quality.

- **Double-layered chassis**

- **High-grade Machined Copper Analog Audio Input Terminals (CD/PHONO Only)**

- **High-grade Machined Copper Speaker Terminals**

High performance

- **Purest Mode**

Even greater improvements in sound quality are facilitated by cutting off the power supply of circuits not required when simply listening.

- **F.C.B.S.**

A Floating Control Bus System (F.C.B.S.) enables the user to connect up to four PM-10 units, making a diversity of applications possible with complete bi-amp and multichannel connections. Moreover, a ground loop is not formed among multiple PM-10 units connected; therefore, sound quality is not adversely affected.

- **BI-AMP Mode**

Complete bi-amp connection proposed by Marantz enables a level of reproduction of the acoustic field never before achieved. Synchronized operation of two PM-10 units is made possible by F.C.B.S. (Floating Control Bus System) connection, with each PM-10 in Bi-Amp mode working as a monaural integrated amplifier.

- **Power Amplifier Mode**

In this mode, this unit works as a power amplifier.

Part names and functions

Front panel

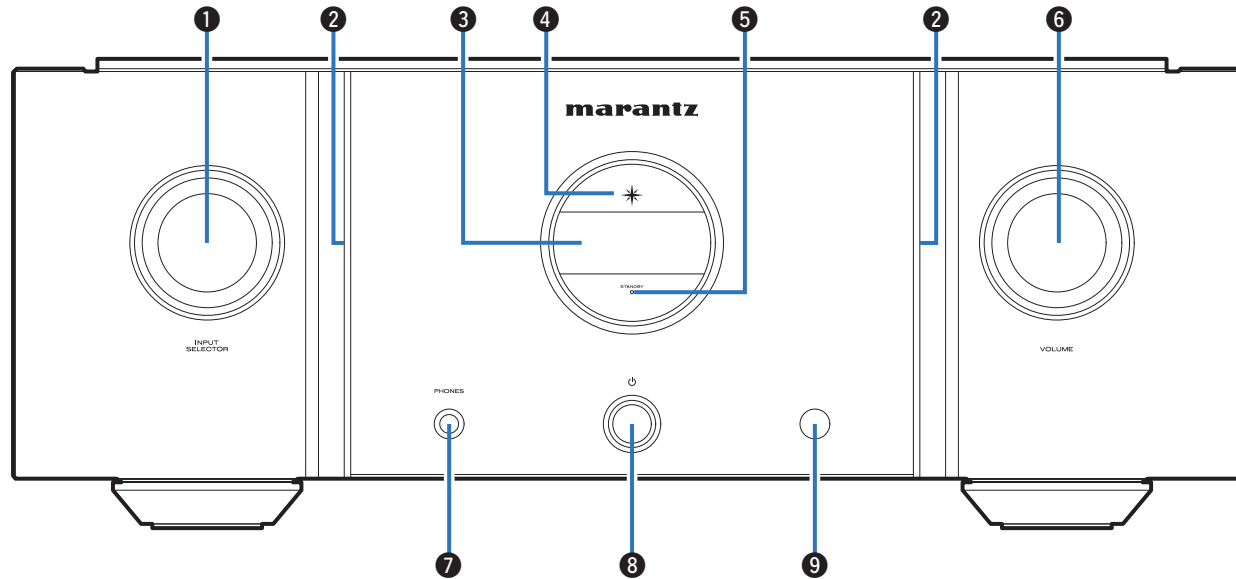

1 Input source select knob (INPUT SELECTOR)

This selects the input source. (👉 p. 17)

2 Illumination lamp

The illumination lamp lights (blue).

3 Display

This displays various pieces of information.

4 Power indicator

This is lit as follows according to the power status:

- Power on : Blue
- Standby : Off
- Power off : Off

5 STANDBY indicator

This is lit as follows according to the power status:

- Power on : Off
- After power on, until the unit is able to be used : Red (blinking)
- Standby : Red
- Power off : Off

6 VOLUME knob

These adjust the volume level. (👉 p. 17)

7 Headphones jack (PHONES)

Used to connect headphones.

Turn off speaker output when using headphones.

NOTE

- To prevent hearing loss, do not raise the volume level excessively when using headphones.

8 Power operation button (⏻)

This turns the power on/off. (👉 p. 17)

9 Remote control sensor

This receives signals from the remote control unit. (👉 p. 2)

Rear panel

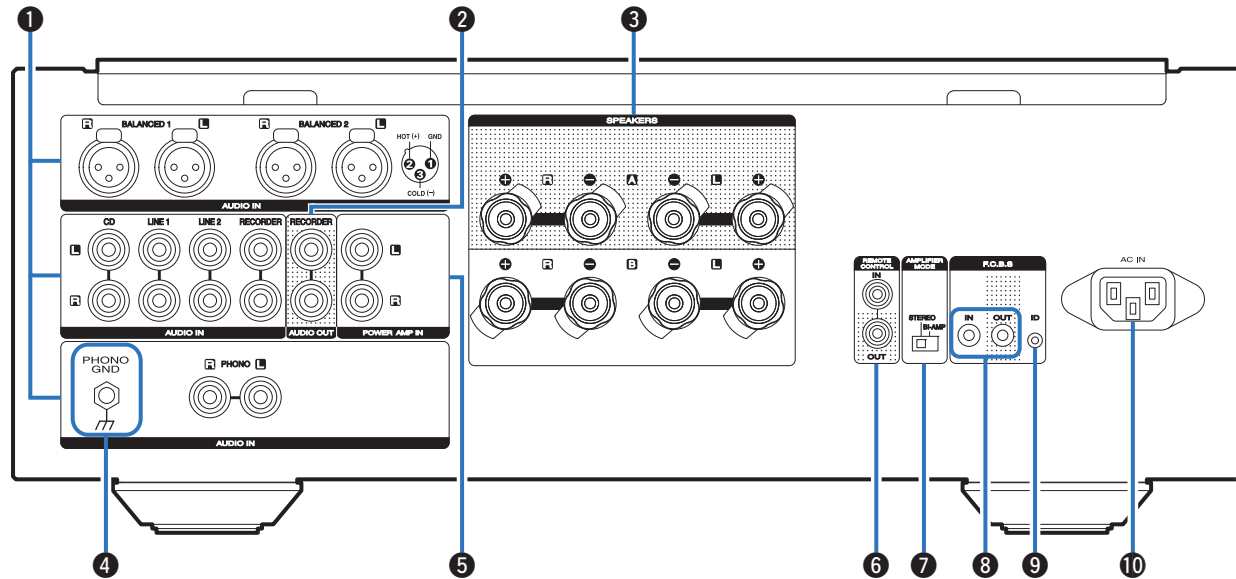
**1 Analog audio input connectors (AUDIO IN)**

Used to connect devices equipped with analog audio output connectors.

- “Connecting a playback device” (☞ p. 10)
- “Connecting a recording device” (☞ p. 10)

2 AUDIO OUT connectors (RECORDER)

Used to connect the input connector of a recorder. (☞ p. 10)

3 Speaker terminals (SPEAKERS)

Used to connect speakers. (☞ p. 8)

4 PHONO GND terminal

Used to connect the ground wire of a turntable. (☞ p. 10)

5 Power amplifier connectors (POWER AMP IN)

Used to connect a pre-amplifier when this unit is used as a power amplifier. (☞ p. 15)

6 Remote control input/output connectors (REMOTE CONTROL)

Used to connect to a Marantz audio device that is compatible with the remote control function. (☞ p. 16)

7 AMPLIFIER MODE switch

Used to switch the amplifier mode (STEREO/BI-AMP). (“Stereo complete bi-amp connection” (☞ p. 12))

8 F.C.B.S. connectors

Used to connect a high quality playback system using two or more of these units. (☞ p. 11)

9 F.C.B.S. ID button

Used to set the ID number for F.C.B.S.. (☞ p. 12)

10 AC inlet (AC IN)

Used to connect the power cord. (☞ p. 16)

Remote control unit

□ Operating this unit

To operate amplifier, press REMOTE MODE AMP button to switch the remote control to the amplifier operation mode.

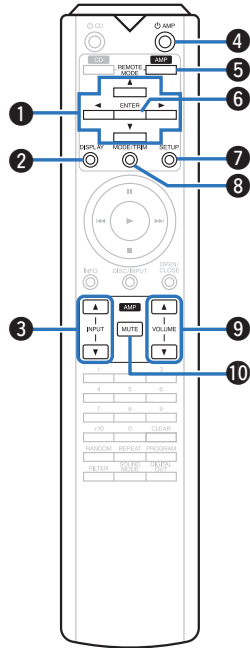

- 1 Cursor buttons (▲▼◀▶)**
 These select items.
- 2 DISPLAY button**
 This turns the display on/off. Press and hold to turn the illumination lamp on/off.
- 3 Input source select buttons (INPUT ▲▼)**
 This selects the input source. (☞ p. 17)
- 4 Power operation button (⏻ AMP)**
 This turns the power on/off (standby). (☞ p. 17)
- 5 Remote mode select button (REMOTE MODE AMP)**
 This switches the remote control to amplifier control mode.
- 6 ENTER button**
 This determines the selection.
- 7 SETUP button**
 This displays the setting menu on the display. (☞ p. 20)
- 8 Volume balance adjustment menu button (MODE/TRIM)**
 This displays the volume balance adjustment menu on the display. (☞ p. 18)
- 9 VOLUME buttons (▲▼)**
 These adjust the volume level. (☞ p. 17)
- 10 MUTE button**
 This mutes the output audio. (☞ p. 18)

□ CD player operations

The supplied remote control can be used to control a Marantz CD player in addition to this unit. To operate a Marantz CD player, press the REMOTE MODE CD button to switch the remote control to the CD player operation mode.

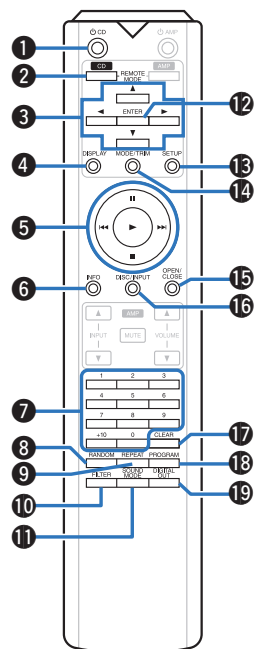

- 1 Power operation button (⏻ CD)
- 2 Remote mode select button (REMOTE MODE CD)
- 3 Cursor buttons (⬆️⬇️⬅️⬇️⬆️)
- 4 DISPLAY button
- 5 System buttons
 - Skip buttons (⏮️ / ⏭️)
 - Stop button (⏹️)
 - Play button (▶️)
 - Pause button (⏸️)
- 6 Information button (INFO)
- 7 Number buttons (0 – 9, +10)
- 8 RANDOM button
- 9 REPEAT button
- 10 FILTER button
- 11 SOUND MODE button
- 12 ENTER button
- 13 SETUP button
- 14 Playback mode switching button (MODE/TRIM)
- 15 OPEN/CLOSE button
- 16 DISC/INPUT button
- 17 CLEAR button
- 18 PROGRAM button
- 19 DIGITAL OUT button



- Basic amplifier operations such as switching input source, adjusting volume, and muting are also possible when the operation mode of the remote control is set to CD.
- When using it, also refer to the operating instructions of the other devices.
- The remote control may not operate some products.

Connections

Contents

Connecting speakers	8
Connecting a playback device	10
Connecting a recording device	10
F.C.B.S. connection	11
Connecting a pre-amplifier	15
Connecting devices with remote control connectors	16
Connecting the power cord	16

NOTE

- Do not plug in the power cord until all connections have been completed.
- Do not bundle power cords together with connection cables. Doing so can result in humming or noise.

Cables used for connections

Provide necessary cables according to the devices you want to connect.

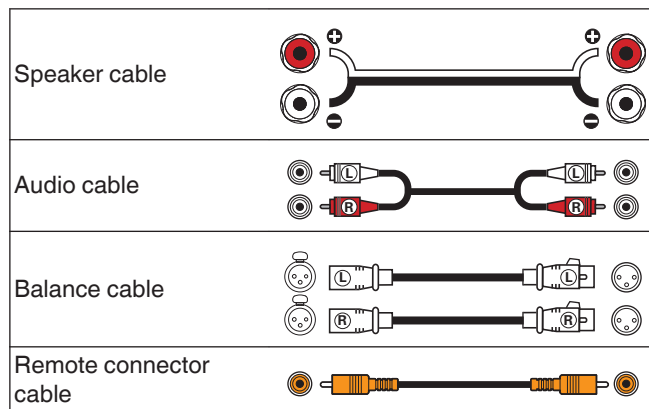

Connecting speakers

NOTE

- Disconnect this unit's power plug from the power outlet before connecting the speakers.
- Connect so that the speaker cable core wires do not protrude from the speaker terminal. The protection circuit may be activated if the core wires touch the rear panel or if the + and - sides touch each other. ("Protection circuit" (p. 27))
- Never touch the speaker terminals while the power cord is connected. Doing so could result in electric shock.
- Use speakers with impedances within the ranges shown below to suit how they are used.

Speaker terminals used on this unit	No. of connected speakers	Speaker Impedance
SPEAKERS A (Standard connection)	2 (one set)	4 – 16 Ω/ohms
SPEAKERS B	2 (one set)	4 – 16 Ω/ohms
SPEAKERS A and SPEAKERS B	4 (two sets)	8 – 16 Ω/ohms
SPEAKERS A and SPEAKERS B (Bi-wiring connection)	2 (one set)	4 – 16 Ω/ohms

Connecting the speaker cables

Carefully check the left (L) and right (R) channels and + (red) and – (black) polarities on the speakers being connected to this unit, and be sure to connect the channels and polarities correctly.

- Peel off about 10 mm of sheathing from the tip of the speaker cable, then either twist the core wire tightly or terminate it.



- Turn the speaker terminal counterclockwise to loosen it.



- Insert the speaker cable's core wire to the hilt into the speaker terminal.

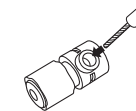

- Turn the speaker terminal clockwise to tighten it.

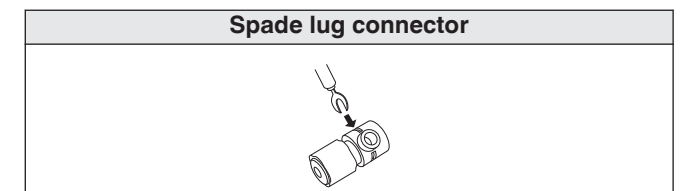
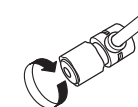

Speaker connection

This unit is equipped with two sets of speaker terminals (SPEAKER A and SPEAKER B). One set of speakers can be connected to each set of terminals, and a total of two sets of speakers can be connected.

The same signal is output from the SPEAKERS A and SPEAKERS B terminals.

When only one set of speakers is to be connected, use either the SPEAKERS A or SPEAKERS B terminals.

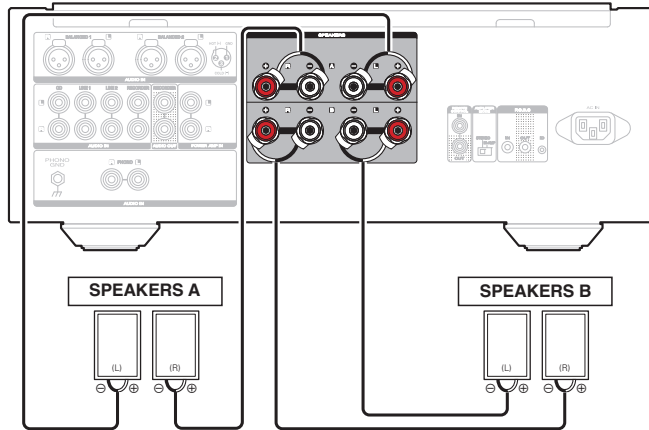

Bi-wiring connection

This connection limits the effects of signal interference between the high range speakers (tweeters) and low range speakers (woofers), allowing you to enjoy high quality playback.

When bi-wiring with bi-wireable speakers, connect the mid and high range terminals to SPEAKERS A (or SPEAKERS B), the low range terminals to SPEAKERS B (or SPEAKERS A).

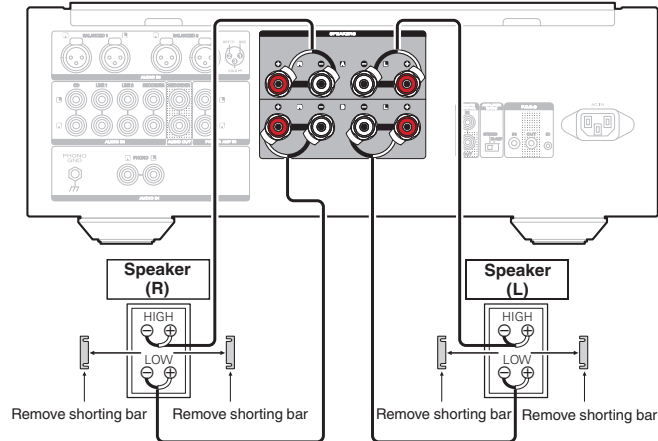

Connecting a playback device

You can connect turntables, tuners, CD players and network audio players to this unit.

Set the phono equalizer of this unit in the "PHONO" section of the setting menu according to the type of turntable cartridge to be connected. (p. 21)

If you set this unit's input source to "PHONO" and you accidentally increase the volume without having a turntable connected, you may hear a hum noise from the speakers.

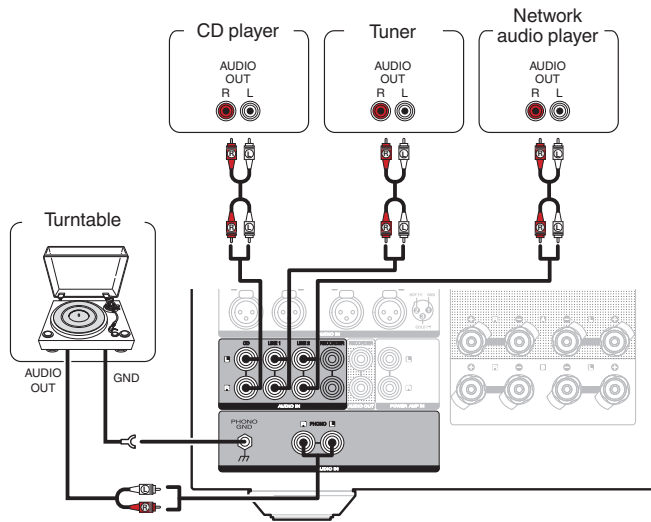

NOTE

- The earth terminal (PHONO GND) of this unit is not for safety grounding purposes. If this terminal is connected when there is a lot of noise, the noise can be reduced. Note that depending on the turntable, connecting the ground line may have the reverse effect of increasing noise. In this case, it is not necessary to connect the ground line.



- The PHONO input terminals are equipped with a short pin-plug. Remove this plug to connect a record player. Store the removed short pin-plug in a safe place so as not to lose it.

About balanced connectors

This unit has both unbalanced and balanced connectors. The balanced connectors have three pins, making it possible to transmit audio signals as a balanced signal, reducing the effect of external noise. They also have a removable lock mechanism, which reduces shaking in the connector area, making the connection highly reliable.

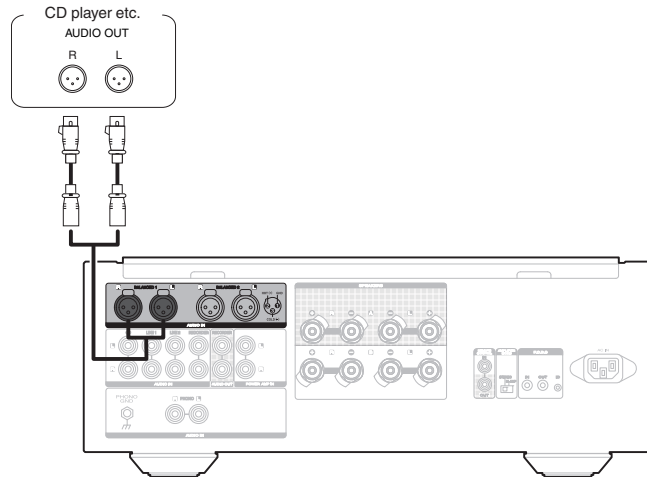

Phases of the balanced connectors

The XLR connector for professional use is internally wired in either of the following two systems. This unit employs the European system.

- USA system (② PIN=COLD ③ PIN=HOT)

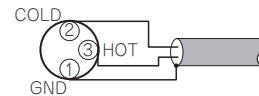

- European system (② PIN=HOT ③ PIN=COLD)

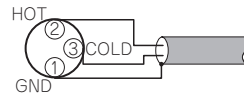

If a product that employs the USA system is connected with this unit via a balanced cable, the output signal may be phase-inverted. To correct the inversion, connect the one side XLR connector reversing the ② PIN and ③ PIN.

Connecting a recording device

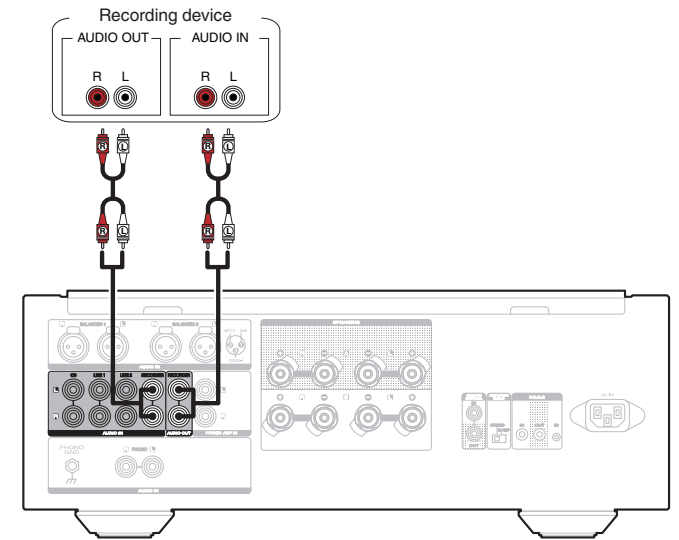

NOTE

- Never insert the short-circuiting pin plug into the recording output connectors (AUDIO OUT RECORDER). Doing so could result in damage.

F.C.B.S. connection

The Marantz F.C.B.S. (Floating Control Bus System) is the high quality sound system for link control between multiple PM-10 units (up to 4 units). Each unit is controlled via its ID number registered beforehand.

The ID numbers need to be set to an operating unit (master) and a subordinate unit (slave) receiving the command from the master. For slave units, register ID numbers in the order of command reception from the master.

Once registered the ID numbers, the units will enable link control operations such as input selection, volume control, on/off selection of muting, display, etc.

Furthermore, F.C.B.S. connection of multiple units has the feature that switches this unit's output from stereo to monaural so that the unit can work as a monaural output amplifier. Follow the respective instructions to make the necessary settings.

Preparation for F.C.B.S. connection

□ Making the F.C.B.S. connection

To use multiple PM-10 units, make this connection in addition to audio connection.

For details on each connection feature, refer to the respective instructions.

Prepare the correct number of portable audio connection cables for the number of units to be connected. Either of the following types of connection cables are adequate.

- Φ 3.5 Monaural mini plug \leftrightarrow Φ 3.5 monaural mini plug connecting cable

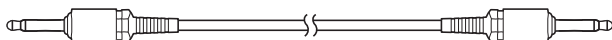

- Φ 3.5 Stereo mini plug \leftrightarrow Φ 3.5 stereo mini plug connecting cable

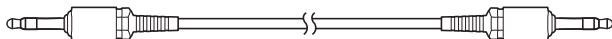

NOTE

- Do not use connecting cables that contain resistance.

□ Connection example

In the connection of the following example, an unit with ID number 1 acts as a master amplifier to control all the other slave units with ID numbers 2 to 4.

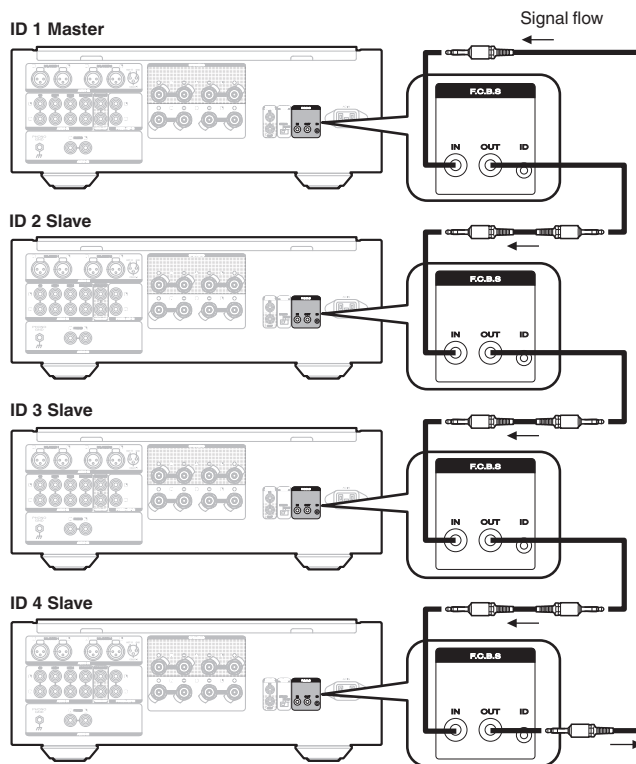

NOTE

- The PM-10 F.C.B.S. function is only valid between the same PM-10 models.
- To turn the power of multiple F.C.B.S.-connected units ON/OFF, switch the power ON in order of lowest to highest ID number, and switch the power OFF in order of highest to lowest ID number.

How to set ID number for F.C.B.S.

When the unit is turned on, the display shows the ID number for three seconds.

For a master unit, ID number 1 needs to be assigned.

For a slave unit, set any of ID numbers 2 to 4.

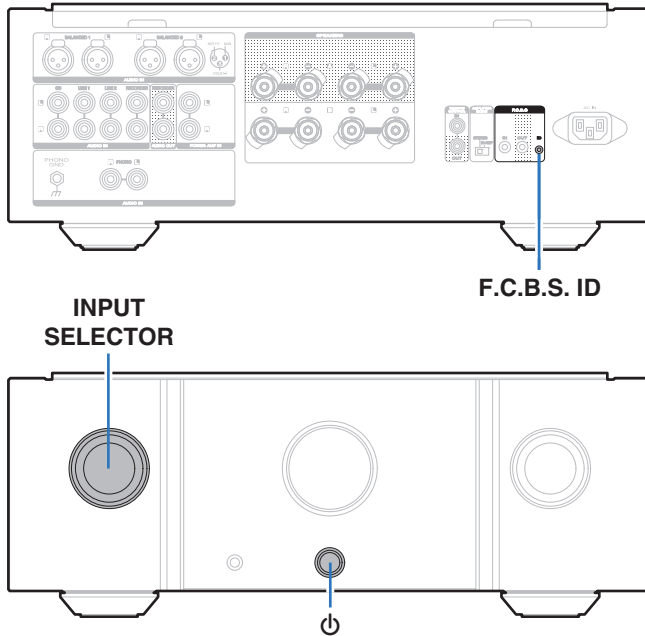

- 1** While holding F.C.B.S. ID on the rear panel, press .
- 2** Turn INPUT SELECTOR on the unit to select an ID number.
- 3** Turn the unit off.
- 4** Again turn the unit on.
 - The setting is saved.
 - The unit registered as a slave shows “SLAVE” on the display.

NOTE

- If using this unit by itself as a stereo amplifier, set the ID number to “0” (Default setting is “0”).
- If the ID number is set to a number other than “0”, this unit cannot be used for standalone operation.

Stereo complete bi-amp connection

This mode enables the two amplifiers connected to this unit to function as one monaural amplifier. To use this mode, two F.C.B.S. connected PM-10 units are required.

To switch the mode, use the AMPLIFIER MODE switch on the rear panel while the power is off.

The figures below show example displays in the stereo and bi-amp modes.

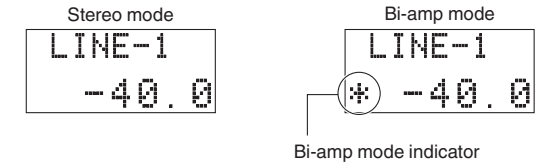

In bi-amp mode, connect to the left channel input jack. The right channel input is disabled.

The same signals are output from the left and right speaker terminals.

NOTE

- Always turn the power to the unit OFF before changing the operating mode switch setting. Turning the power ON again activates the new setting.
- When in bi-amp mode, the R channel input jacks cannot be used.
- When in bi-amp mode, the signals input into the L channel are output from both channels. Therefore, the same signals are output from the L channel and R channel in RECORDER OUT, headphones jack.
- Speaker systems connected using complete bi-amp connections must support bi-amp connections. Before connecting your speakers, check in the instruction manual that came with the speakers or contact the manufacturer to confirm whether they support bi-amp connection.

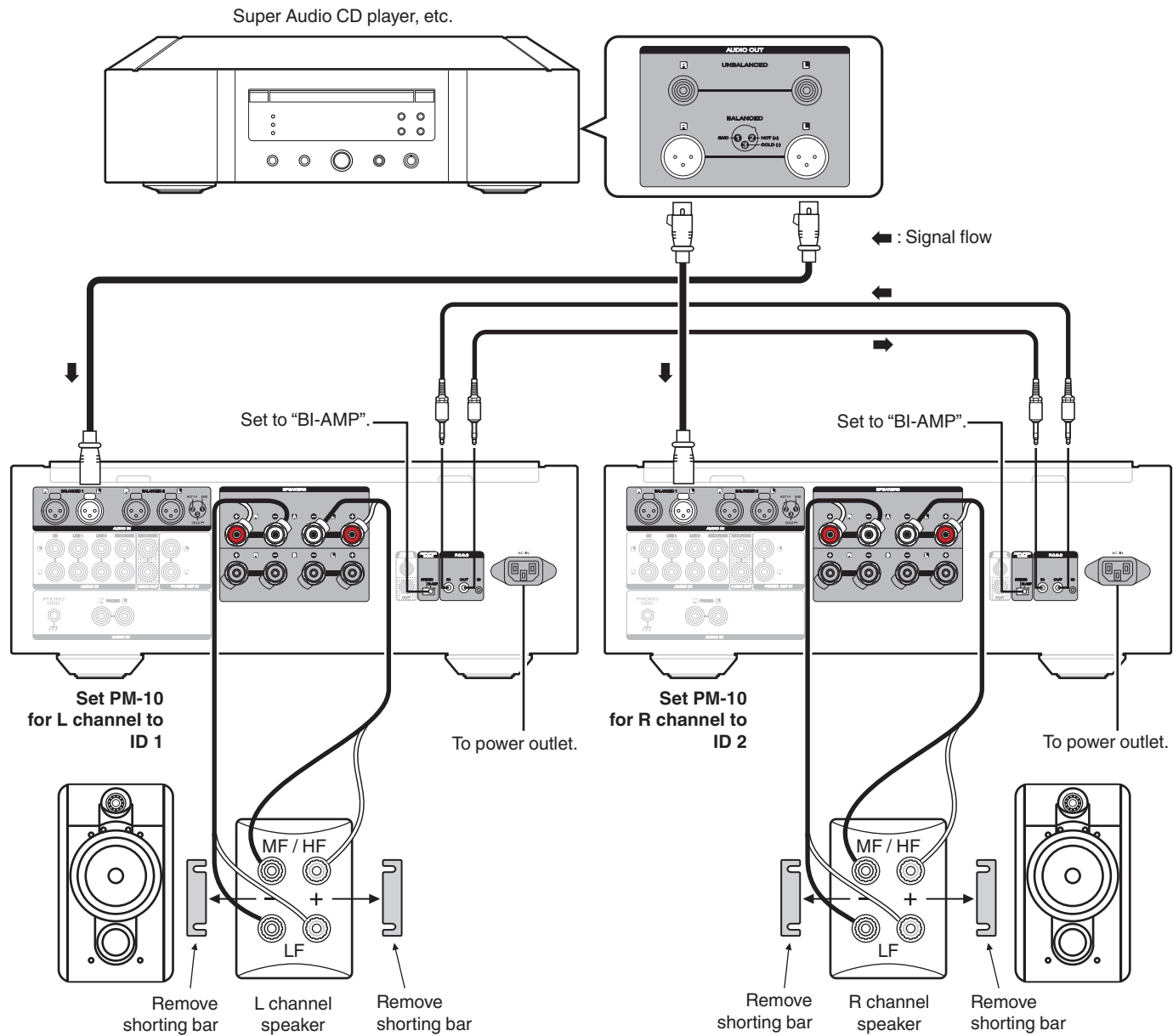

Connection for 5.1 Multi-channel Playback

The three units are connected using F.C.B.S. For the F.C.B.S connection, prepare 3 audio connection cables, and refer to F.C.B.S.. (👉 p. 11)

Connect the outputs of players that have 5.1 channel analog outputs to each of the three units.

If using an active subwoofer, see the instruction manual that came with the subwoofer for further instructions.

Set the ID numbers for the three amplifiers as explained in How to set ID number for F.C.B.S.. (👉 p. 12)

- When the ID 1 unit is operated, ID 2 and ID 3 units will operate in sync.

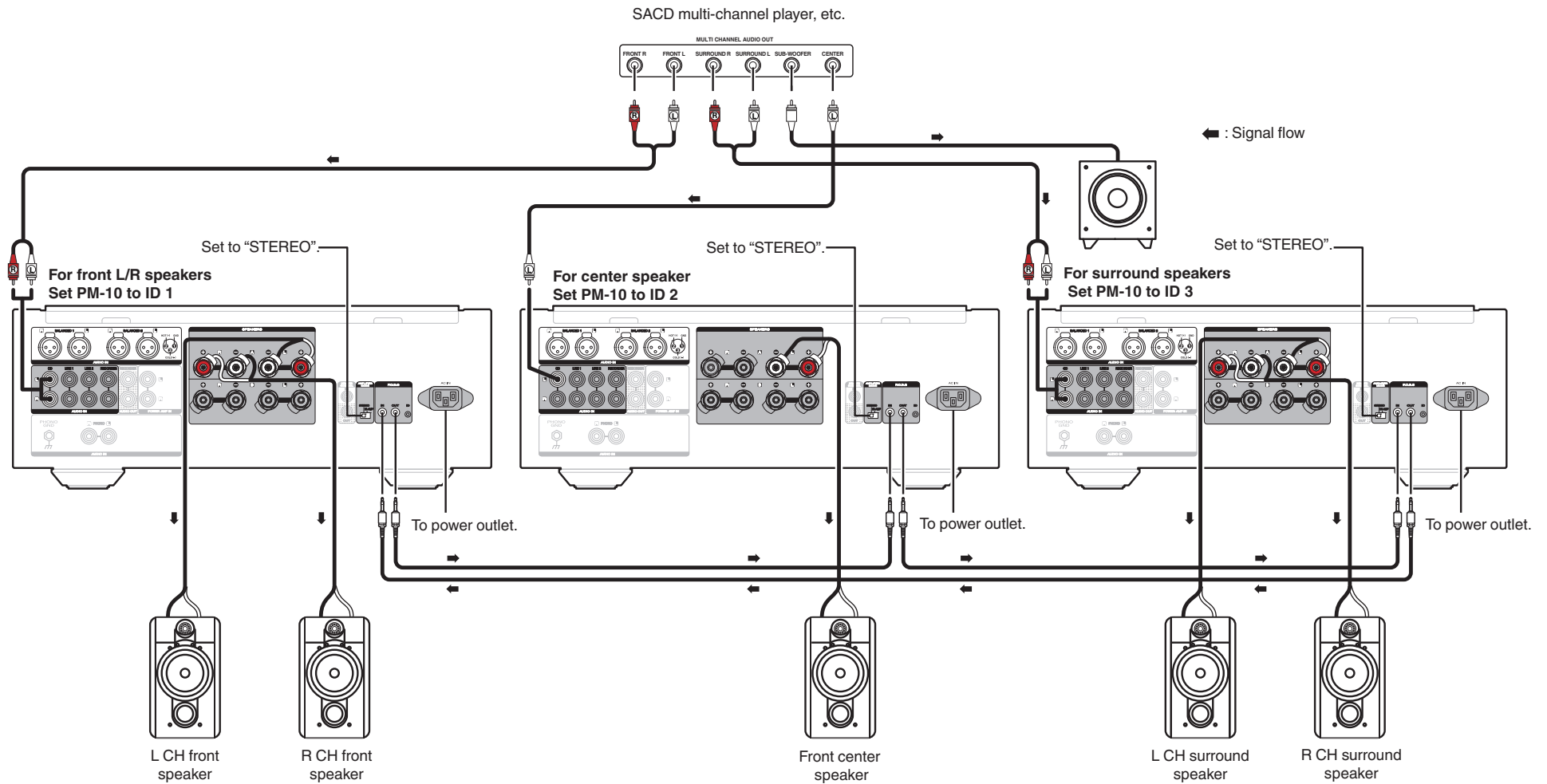

Speaker Positioning for Super Audio Multi-channel Sound

In order to enjoy Super Audio CD multi-channel sound with the best possible acoustics, it is recommended to position speakers as specified in ITU-R BS.775-1 of the International Telecommunication Union (ITU). Super Audio CD multichannel discs are recorded and mixed so as to achieve the optimum effect with a speaker system laid out as specified in ITU-R BS.775-1.

- With Super Audio CD multi-channel discs, the music signals are basically recorded using 5 channels (3 - 6 channels sometimes), but in some cases, LFE (for subwoofer) is recorded as a sixth channel.
- Each disc indicates how many channels have been recorded on it.
- The basic layout is 3 speakers in the front and 2 in the back since multi-channel discs usually have 5 channels. The 2 front, 1 center and 2 surround (rear) speakers should be set in a circle around the listening point. If using speakers of differing sizes, adjust volume balance from the amplifier.
- The location of the subwoofer in the figure is just for explanatory purposes. It can be located anywhere in the room. For connection and positioning instructions, see the instruction manual that came with the subwoofer.

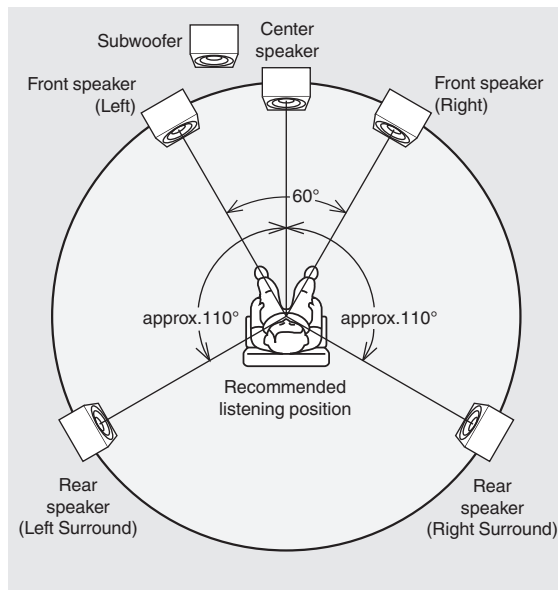

- ITU (International Telecommunication Union)
The ITU is a special organization of the United Nations. It consists of a number of organs, one of which is the Radio Broadcasting Section. ITU-R BS in the recommendation which consists of standards relating to broadcasting (audio) operations, one of which is the ITU-R BS.775-1 which governs "multi-channel stereo sound systems".

Connecting a pre-amplifier

If you use a pre-amplifier, connect it as shown below, and then you can use this unit as a power amplifier.

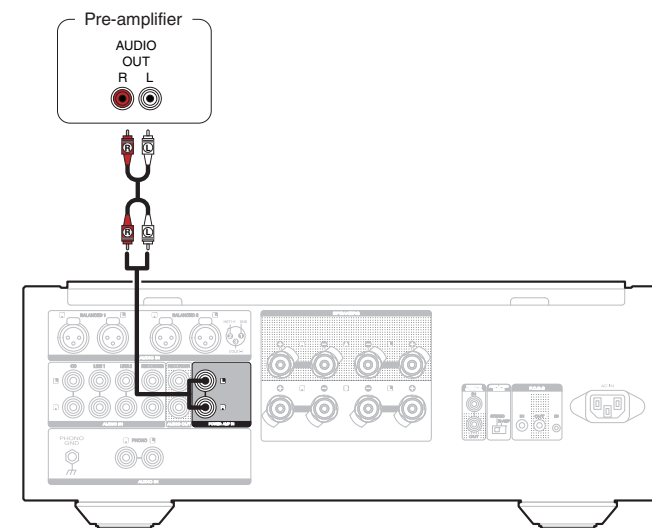

- 1 Turn **INPUT SELECTOR** on the unit to select the input source to "POWER AMP".



- The POWER AMP IN terminals are equipped with a short pin-plug. Remove this plug to connect a pre-amplifier. Store the removed short pin-plug in a safe place so as not to lose it.
- You cannot use the input source switching buttons on the remote control unit to select "POWER AMP".

NOTE

- When the input source is POWER AMP, adjustment of the volume, muting and balance has no effect. Adjust the volume on the pre-amplifier.
- When the input source is set to POWER AMP, you cannot use the remote control unit to select the input source.
- When the input source is POWER AMP, the main unit outputs at maximum volume. Check the output level on the input device before playing it and adjust the volume accordingly.

Connecting devices with remote control connectors

Performing operations by RC on this unit without visual contact

You can connect an external IR receiver to the REMOTE CONTROL connectors to perform operations on this unit with the supplied remote control unit without visual contact. This might be necessary if the unit is hidden in a cupboard or corner, so you can't directly point with the remote control unit to the device.

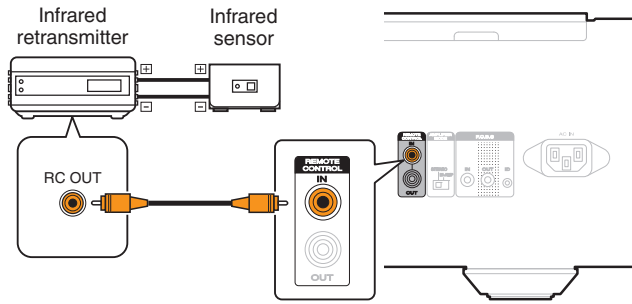

Remotely connecting Marantz audio devices

You can transmit remote control signals simply by connecting a Marantz audio device to the REMOTE CONTROL IN/OUT connectors using the remote connection cable provided with the device.

Set the remote control switch located on the rear panel of the connected audio component to "EXTERNAL" to use this feature.

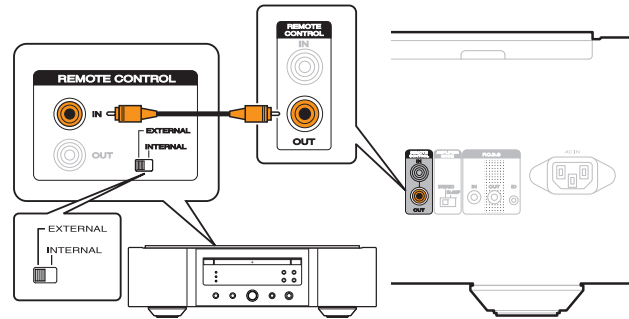

Connecting the power cord

Wait until all connections have been completed before connecting the power cord.

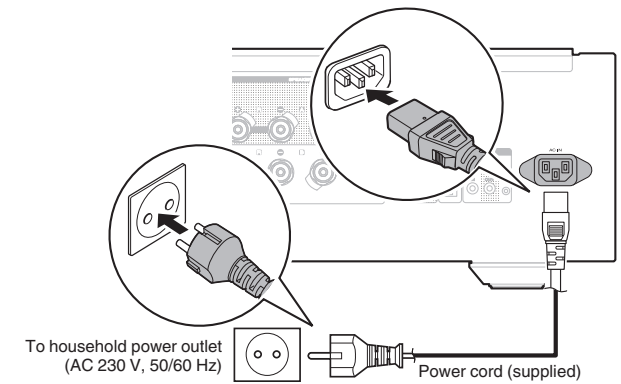

Playback

□ Contents

Turning the power on	17
Selecting the input source	17
Adjusting the volume	17
Turning off the sound temporarily (Muting)	18
Adjusting the left and right channel balance	18
Having the display and the illumination lamp off	18
Having the illumination lamp always off	18
Playing CDs	19
Recording	19

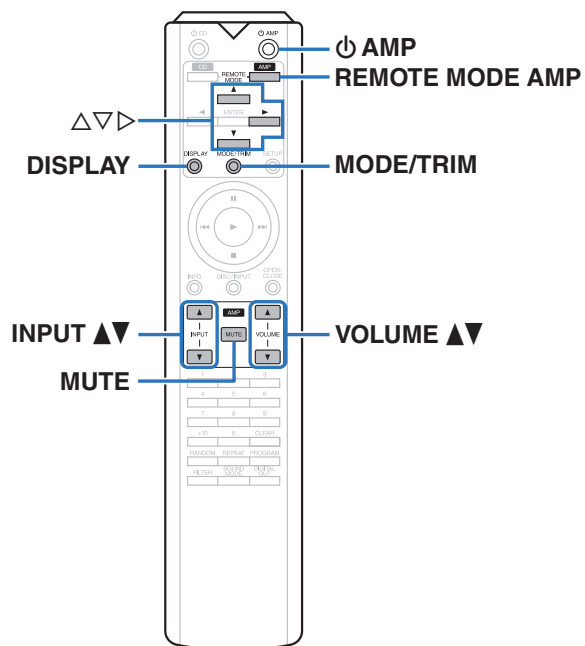

Turning the power on

- 1 Press **AMP** on the main unit to turn the power on.
 - The power indicator lights in blue.
 - The standby indicator blinks in red until the unit is able to be used.



- Press **AMP** on the remote control unit to turn on power from standby mode.
- You can also turn the INPUT SELECTOR on the main unit when the unit is in standby mode to turn on the power.

□ Switching the power to standby

- 1 Press **AMP** on the remote control.
The unit switches to standby mode, and the STANDBY indicator lights red.

NOTE

- Power continues to be supplied to some of the circuitry even when the power is in the standby mode. When leaving home for long periods of time or when going on vacation, either press **AMP** on the main unit to turn off the power, or unplug the power cord from the power outlet.

Selecting the input source

- 1 Use **INPUT ▲▼** to select the input source to be played back.
The selected input source appears on the display.



- You can also select the input source by turning INPUT SELECTOR on the main unit.

Adjusting the volume

- 1 Use **VOLUME ▲▼** to adjust the volume.



- You can also adjust the volume by turning VOLUME on the main unit.

Turning off the sound temporarily (Muting)

- 1 Press MUTE.
“ATT” appears on the display and the sound is muted.



- To cancel mute, press MUTE again.

□ Setting the attenuation level when sound is muted

The attenuation level can be set at -20 dB, -40 dB, or -∞.

- The factory default setting is -∞.

- 1 Press and hold MUTE for 2 seconds or longer.
The attenuation level will appear on the display.

- 2 Press MUTE.
The attenuation level setting value changes each time the button is pressed.



- If not operated for 2 seconds, the current setting is saved and the display returns to normal.

Adjusting the left and right channel balance

The volume level of the left and right channels can be trimmed in 0.5 dB steps across a 0.0 — 9.0 dB range. The factory default setting is 0.0 dB (maximum).

- 1 Press MODE/TRIM.
The unit enters the level adjustment mode.
 - The left channel level value flashes.

- 2 Use Δ / ∇ to adjust the left channel level.

- 3 Press \triangleright .
The adjustment mode selects the right channel.
 - The right channel level value flashes.

- 4 Use Δ / ∇ to adjust the right channel level.

- 5 Press MODE/TRIM.
The unit exits the adjustment mode.
 - If you have connected a “SLAVE” device using the F.C.B.S. connection ( p. 11), proceed to the slave setting.

Having the display and the illumination lamp off

The display circuit operation can be stopped to minimize noise from the display and the display circuit which could interfere with the analog audio output signal.

- 1 Press DISPLAY.
Each time you press DISPLAY, the display and the illumination lamp (blue) switch on/off at the same time.



- If you operate the VOLUME knob or another control when the display is off, the display turns on again. When operation is finished, the display turns off automatically after approximately 2 seconds.

Having the illumination lamp always off

The following procedure makes the illumination lamp always off regardless of the display on/off operation.

- 1 Press and hold DISPLAY for two seconds and longer while display is lighted.
Press and hold DISPLAY for two seconds and longer while the lamp is always off to return to the normal setting.

Playing CDs

This section uses playback from a CD as an example.

- 1** Press **⏻** on this unit to turn the power on.
- 2** Use **INPUT ▲▼** to switch the input source to “CD”.
“CD” is displayed on the display of this unit.
- 3** Playback the CD.
- 4** Use **VOLUME ▲▼** to adjust the volume.

Recording

Audio signals input into this unit can be output to an external recording device. When recording audio from a playback device connected to this unit, audio can be recorded with the playback device still connected to this unit.

- 1** Press **⏻** on this unit to turn the power on.
- 2** Press **INPUT ▲▼** to switch to the input source from which you want to record.
The selected input source is displayed on the display of this unit.
- 3** Recording starts.
 - For information on operations, see the owner’s manual of the recording device.

Settings

Menu map

By default, this unit has recommended settings defined. You can customize this unit based on your existing system and your preferences.

Setting items	Description	Page
PUREST	Switches PUREST mode on or off.	<u>21</u>
PHONO	Sets the phono equalizer of this unit according to the type or impedance of the turntable cartridge to be connected.	<u>21</u>
AUTO STBY (Auto Standby)	Sets whether to automatically switch the unit to the standby mode when the unit remains in the stop mode for more than 30 minutes.	<u>21</u>

Menu operation

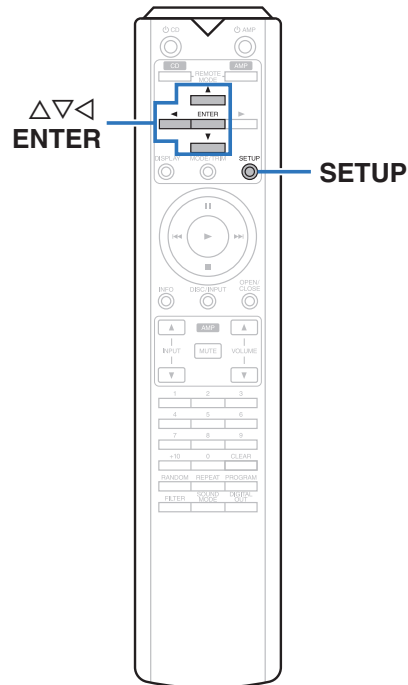

- 1 Press SETUP.**
The menu is displayed on the display.
- 2 Use $\Delta \nabla$ to select the menu to be set or operated, then press ENTER.**
- 3 Use $\Delta \nabla$ to change to desired setting.**
- 4 Press ENTER to enter the setting.**
 - To return to the previous item, press \triangleleft .
 - Exiting the Menu, press SETUP while the menu is displayed.
The display returns to the normal display.

PUREST

Noise sources that influence sound quality can be suppressed in order to achieve higher quality playback by stopping all of the following circuits.

- Recording output circuit
- Non-signal state detection circuit
- Headphones circuit

ON:	Enables the high sound quality mode (PUREST mode).
------------	--

OFF (Default):	Disables the high sound quality mode (PUREST mode).
--------------------------	---



- When PUREST mode is on
 - Audio output from the recorder output connectors stops.
 - The auto standby function stops working.
- When headphones are connected, the headphones circuit is activated and the sound output from the headphones.

PHONO

Sets the phono equalizer of this unit according to the type or impedance of the turntable cartridge to be connected.

MM (Default):	Set this for an MM cartridge.
-------------------------	-------------------------------

MC Low:	Use this setting for an MC cartridge of less than 10 Ω /ohms.
----------------	--

MC High:	Use this setting for an MC cartridge of 10 Ω /ohms or higher.
-----------------	--

NOTE

- If this setting change operation is performed, playback sound is output approximately 10 seconds after the change. (The standby indicator blinks in red until the unit is able to be used.)

AUTO STBY (Auto Standby)

Sets whether to automatically switch the unit to the standby mode when there is no input signal and operation for 30 minutes.

ON (Default):	Enable Auto Standby mode.
-------------------------	---------------------------

OFF:	Disable Auto Standby mode.
-------------	----------------------------



- The display will show the remaining time for three minutes before the units enters standby mode.
- In F.C.B.S. connection, only the ID 1 master unit activates Auto Standby mode. If the ID 1 master unit is operated with no audio input, set the Auto Standby mode to off.

Tips

□ Contents

Tips

I want to adjust the attenuation level when muting sound	23
I want to turn the illumination lamps on both sides of the unit main panel off	23
I want to use two or more of these units for high quality playback	23
I want to use this unit's remote control to operate a Marantz CD player	23
I want to use bi-wiring compatible speakers	23
I want to use this unit as a power amplifier	23
I want to stop some circuits of this unit to enjoy playback with higher sound quality	23

Troubleshooting

Power does not turn on / Power is turned off	24
Operations cannot be performed through the remote control unit	25
No sound comes out	25
Desired sound does not come out	26
Sound is interrupted or noise occurs	26
Error messages	26

Tips

I want to adjust the attenuation level when muting sound

- The attenuation level can be set at -20 dB, -40 dB, or $-\infty$. (🔗 p. 18)

I want to turn the illumination lamps on both sides of the unit main panel off

- Turn the illumination lamp setting off. (🔗 p. 18)

I want to use two or more of these units for high quality playback

- Use the stereo complete bi-amp connections. (🔗 p. 12)
- Use the multi-channel playback connections. (🔗 p. 14)

I want to use this unit's remote control to operate a Marantz CD player

- Press the REMOTE MODE CD button on the remote control unit to switch the remote control unit to the CD player operation mode. (🔗 p. 7)
- Also, refer to the instruction manual of the CD player.

I want to use bi-wiring compatible speakers

- This unit is compatible with bi-wiring connections. Enjoy high quality playback by using bi-wiring connections. (🔗 p. 9)

I want to use this unit as a power amplifier

- Connect the pre amplifier to the POWER AMP IN connectors of this unit. (🔗 p. 15)

I want to stop some circuits of this unit to enjoy playback with higher sound quality

- Set "PUREST" to "ON" in the menu. (🔗 p. 21)

Troubleshooting

If a problem should arise, first check the following:

1. **Are the connections correct?**
2. **Is the set being operated as described in the owner's manual?**
3. **Are the other devices operating properly?**

If this unit does not operate properly, check the corresponding symptoms in this section.

If the symptoms do not match any of those described here, consult your dealer as it could be due to a fault in this unit. In this case, disconnect the power immediately and contact the store where you purchased this unit.

❑ Power does not turn on / Power is turned off

Symptom	Cause / Solution	Page
Power is not turned on.	<ul style="list-style-type: none"> • Check whether the power plug is correctly inserted into the power outlet. 	<u>16</u>
Power automatically turns off.	<ul style="list-style-type: none"> • The Auto Standby mode is on. When approx. 30 minutes pass with no audio input and no operations on the unit, this unit automatically enters the standby mode. To disable Auto Standby mode, set "AUTO STBY" on the menu to "OFF". 	<u>21</u>
Power turns off and the STANDBY indicator flashes in red approx. every 0.5 seconds.	<ul style="list-style-type: none"> • The protection circuit has been activated due to a rise in temperature within this unit. Turn the power off, wait about an hour until this unit cools down sufficiently, and then turn the power on again. 	<u>27</u>
	<ul style="list-style-type: none"> • Please re-install this unit in a place having good ventilation. 	—
	<ul style="list-style-type: none"> • Check the speaker connections. The protection circuit may have been activated because speaker cable core wires came in contact with each other or a core wire was disconnected from the connector and came in contact with the rear panel of this unit. After unplugging the power cord, take corrective action such as firmly re-twisting the core wire or taking care of the connector, and then reconnect the wire. 	<u>8</u>
	<ul style="list-style-type: none"> • Turn down the volume and turn on the power again. 	<u>17</u>
	<ul style="list-style-type: none"> • This unit's amplifier circuit has failed. Unplug the power cord and contact our customer service center. 	—

❑ Operations cannot be performed through the remote control unit

Symptom	Cause / Solution	Page
Operations cannot be performed through the remote control unit.	• Batteries are worn out. Replace with new batteries.	<u>2</u>
	• Operate the remote control unit within a distance of about 7 m from this unit and at an angle of within 30°.	<u>2</u>
	• Remove any obstacle between this unit and the remote control unit.	—
	• Insert the batteries in the proper direction, checking the ⊕ and ⊖ marks.	<u>2</u>
	• The set's remote control sensor is exposed to strong light (direct sunlight, inverter type fluorescent bulb light, etc.). Move the set to a place in which the remote control sensor will not be exposed to strong light.	—
	• When using a 3D video device, the remote control unit of this unit may not function due to effects of infrared communications between units (such as TV and glasses for 3D viewing). In this case, adjust the direction of units with the 3D communications function and their distance to ensure they do not affect operations from the remote control unit of this unit.	—
	• Press the REMOTE MODE AMP button to switch the remote control operating mode to "AMP".	<u>6</u>

❑ No sound comes out

Symptom	Cause / Solution	Page
No sound comes out of speakers.	• Check the connections for all devices.	<u>8</u>
	• Insert connection cables all the way in.	—
	• Check that input connectors and output connectors are not reversely connected.	—
	• Check cables for damage.	—
	• Check that speaker cables are properly connected. Check that cable core wires come in contact with the metal part on speaker terminals.	<u>8</u>
	• Securely tighten the speaker terminals. Check speaker terminals for looseness.	<u>8</u>
	• Check that the proper input source is selected.	<u>17</u>
	• Adjust the volume.	<u>17</u>
	• Cancel the muting mode.	<u>18</u>
	• No sound is output from the speakers when headphones are connected.	<u>4</u>

❑ Desired sound does not come out

Symptom	Cause / Solution	Page
No sound comes out of a specific speaker.	• Check that speaker cables are properly connected.	<u>8</u>
	• Adjust the left and right channel balance.	<u>18</u>
The left and right of stereo sound is reversed.	• Check whether the left and right speakers are connected to the correct speaker terminals.	<u>8</u>

❑ Sound is interrupted or noise occurs

Symptom	Cause / Solution	Page
When playing a record, the sound is distorted.	• Adjust to a proper needle pressure.	—
	• Check the tip of the needle.	—
	• Replace the cartridge.	—
When playing a record, a humming noise comes out of the speakers.	• Check that the turntable is connected correctly.	<u>10</u>
	• If there is a TV or AV device near the turntable, such devices may affect the playback sound. Install the turntable in a location as far away as possible from the TV or other AV devices.	—
When playing a record, a humming noise comes out of the speakers when the volume is high. (Howling phenomenon)	• Install the turntable and speakers as far from each other as possible.	<u>10</u>
	• The vibrations from the speakers are being transmitted to the player through the floor. Use cushions, etc., to absorb the speakers' vibrations.	—

Error messages

When multiple amplifiers are connected by F.C.B.S., the error messages described in the table below may be displayed on the display. In such a case, ID number setting or remote cable connection may be in failure. Check the ID number or remote cable connection, referring to the table below. For details on ID number setting, see “How to set ID number for F.C.B.S.” (👉 p. 12).

Indication	Meaning	Cause / Solution
ERROR 02	Multiple amplifiers take ID No.2.	• Assign different ID numbers to the amplifiers.
ERROR 03	Multiple amplifiers take ID No.3.	
ERROR 04	Multiple amplifiers take ID No.4.	
ERROR 11	The amplifiers with ID No.2-4 cannot communicate with the amplifier with ID No.1.	• If the amplifier with ID No.1 is not on, turn it ON. • Check that the remote cable is properly connected.
ERROR 12	The amplifier with ID No.1 cannot communicate with the amplifiers with ID No.2-4.	• If multiple amplifiers take ID No.1, set ID numbers properly. • If the amplifier with ID No.1 is connected to the amplifier with ID No.0, set ID numbers properly. • Check that the remote cable is properly connected.

Appendix

Explanation of terms

MM/MC cartridge

There are two types--MM (Moving Magnet) and MC (Moving Coil)--of cartridges for turntable. As the output levels for these two types of cartridges differ, the setting of the phono equalizer that is mounted in this unit must be switched according to the type of cartridge for your turntable. Change this setting in the "PHONO" section of the setting menu. (👉 p. 21)

Speaker impedance

This is an AC resistance value, indicated in Ω (ohms). Greater power can be obtained when this value is smaller.

Protection circuit

This is a function to prevent damage to devices within the power supply when an abnormality such as an overload, excess voltage occurs or over temperature for any reason. If a malfunction occurs in this unit, the power indicator blinks red and the unit switches to standby mode.

Trademark information



Adobe, the Adobe logo and Reader are either registered trademarks or trademarks of Adobe Systems Incorporated in the United States and/or other countries.

Specifications

• RMS Power output (Simultaneous drive of both channels) :	200 W x 2 (8 Ω /ohms load, 1 kHz, T.H.D. 0.05 %) 400 W x 2 (4 Ω /ohms load, 1 kHz, T.H.D. 0.1 %)
• Total harmonic distortion (1 kHz, simultaneous drive of both channels, 100 W, 8 Ω/ohms load) :	0.005 %
• Frequency response (CD, 1 W, 8 Ω/ohms load) :	5 Hz – 50 kHz \pm 3 dB
• Damping factor (8 Ω/ohms load, 20 Hz – 20 kHz) :	500
• Input sensitivity/Input impedance	
PHONO (MC Low) :	280 μ V/33 Ω /ohms
PHONO (MC High) :	280 μ V/133 Ω /ohms
PHONO (MM) :	2.6 mV/47 k Ω /kohms
BALANCED :	880 mV/40 k Ω /kohms
CD/LINE/RECORDER :	440 mV/20 k Ω /kohms
POWER AMP :	1.5 V/20 k Ω /kohms
• Maximum allowable PHONO input level (1 kHz)	
MC :	8 mV
MM :	80 mV
• RIAA deviation (20 Hz – 20 kHz) :	\pm 0.5 dB
• S/N (IHF-A, 8 Ω/ohms load)	
PHONO (MC) :	76 dB (0.5 mV Input, 1 W Output)
PHONO (MM) :	88 dB (5 mV Input, 1 W Output)
BALANCED :	111 dB (4 V Input, Rated output)
CD/LINE/RECORDER :	111 dB (2 V Input, Rated output)
• Power requirement :	AC 230 V, 50/60 Hz
• Power consumption :	270 W
• Power consumption in standby mode :	0.3 W

For the purpose of improvement, the specifications and design are subject to change without notice.

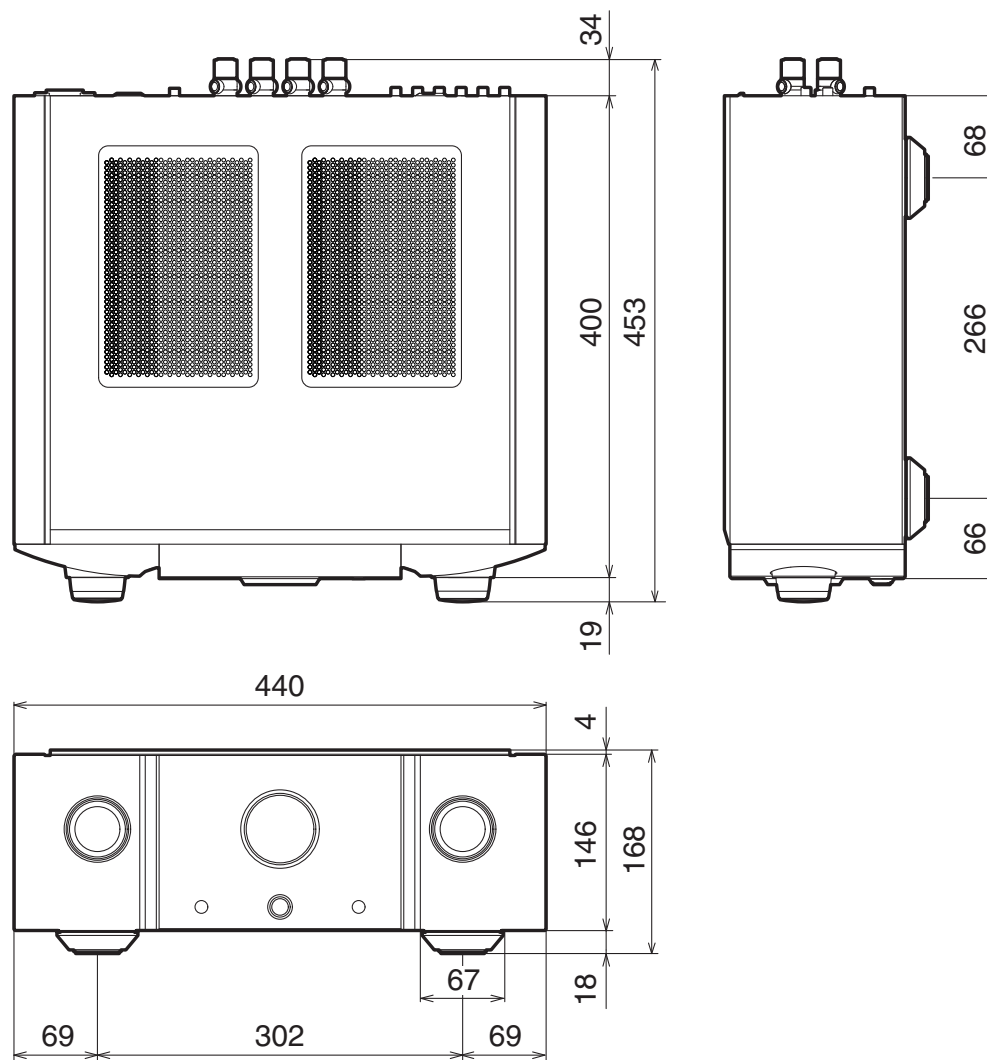
□ **Dimensions** (Unit : mm)□ **Weight : 21.3 kg**

Index

A		M		S	
Auto Standby mode	21	Menu map	20	Speaker impedance	27
		Muting	18	Speakers	8
B					
Bi-wiring	9	N		T	
		Network audio player	10	Tips	23
C				Troubleshooting	24
CD player	10, 19	P		Tuner	10
		Protection circuit	27	Turntable	10
D					
Display brightness	18	R		V	
		Rear panel	5	Volume	17
F		Recording device	10		
F.C.B.S.	11	Remote control	16		
Front panel	4	Remote control unit	6		
I					
Input source	17				

www.marantz.com

You can find your nearest authorized distributor or dealer on our website.

marantz[®] is a registered trademark.

35201042700AMA

Copyright © 2017 D&M Holdings Inc. All Rights Reserved.