

marantz

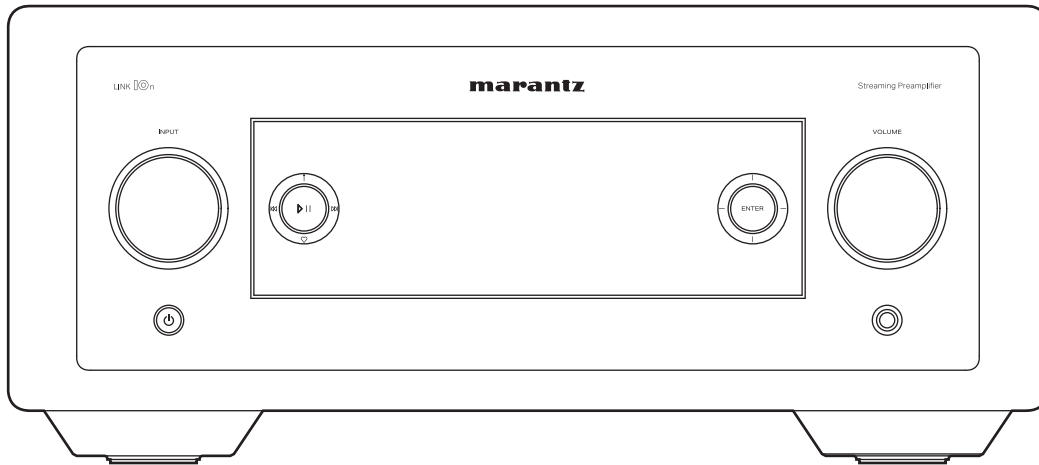

LINK | On | Streaming Preampifier

Owner's Manual

Accessories	7
Inserting the batteries	8
Operating range of the remote control unit	8
Part names and functions	9
Front panel	9
Rear panel	12
Remote control unit	15

Connections

Connecting an amplifier	22
Connecting the subwoofer	24
Connecting a playback device	25
Connecting a TV	27
Connecting this unit to the HDMI ARC terminal on a TV	27
Connecting this unit to the Optical or Coaxial terminal on a TV	29
Connecting to a device with digital audio input connectors	31
Connecting to a device with digital audio output connectors	32
Connecting a PC or Mac	33
Connecting a USB flash drive to the USB port	34
Connecting to a home network (LAN)	35
Wired LAN	35
Wireless LAN	36
Connecting an external control device	37
FLASHER IN jack	37
REMOTE CONTROL connectors	38
Connecting the power cord	40



Playback

Basic operation	42
Turning the power on	42
Switching the power to standby	42
Selecting the input source	43
Adjusting the volume	43
Turning off the sound temporarily (Muting)	44
Listening to Internet Radio	45
Listening to Internet Radio	46
Playing back files stored on PC or NAS	47
Playing back files stored on PC or NAS	48
Playing a USB flash drive	50
Playing files stored on USB flash drives	51
Listening to music on a Bluetooth device	53
Listening to music on a Bluetooth device	54
Pairing with other Bluetooth devices	55
Reconnecting to this unit from a Bluetooth device	56
Listening to audio on Bluetooth headphones	57
Listening to audio on Bluetooth headphones	58
Reconnecting to a Bluetooth headphones	59
Disconnecting Bluetooth headphones	59

Getting the HEOS app	60
Setting up the HEOS app for the first time with a HEOS Built-in device	61
Adding the registration of HEOS Built-in devices in the HEOS app	62
HEOS Account	63
Playing from streaming music services	64
Listening to the same music in multiple rooms	66
Playing digital input	70
Connecting and playing back from a TV or digital device (HDMI/Coaxial/Optical 1/Optical 2)	70
Connecting and playing back from a computer (USB-DAC)	72
Playing analog input	82
AirPlay function	83
Playing songs from your iPhone, iPod touch, iPad or Mac	84
Playing songs from Windows PC	84
Play a song from your iPhone, iPod touch, iPad or Mac on multiple synced devices (AirPlay 2)	85
Spotify Connect function	86
Playing Spotify music with this unit	86



Convenience functions	87
Playing back HEOS Favorites	88
Adding to HEOS Favorites	88
Deleting a HEOS Favorites	89
Adjusting the tone and balance	89
Playback in source direct mode	90
Switching the display's brightness	91
Turning the illumination and display on/off	91
Using the sleep timer	92
Displaying the volume at all times (When "Preamp Out" is set to "On")	92
Smart select function	93

Settings

Menu map	94
Menu operation	96
Audio	97
Filter	97
Dither	97
Noise Shaper	98
Preamp Out	98
Volume Scale	99
Volume Limit	99
Digital Out	99
HP Amplifier Gain	99
Phono	100
Low Pass Filter	100
TV	101
TV Input	101
HDMI Power Off Control	102
General	103
Illumination	103
Language	103
Auto-Standby	104
Reset	104



Network	105
Network Information	105
Wi-Fi	105
Bluetooth	106
Network Control	107
AirPlay Setup	108
Connecting to the network by using the WPS button on the router	109
Disabling amplifier/SACD player operating mode on remote control	110
Disabling amplifier operating mode	111
Disabling SACD player operating mode	111
Setting the device to be operated by the volume buttons on the remote control	112
Setting the device to be operated by the volume buttons in streaming preamplifier operating mode	113
Setting the device to be operated by the volume buttons in SACD player operating mode	113

Tips

Tips	115
Troubleshooting	117
Power does not turn on / Power is turned off	118
Operations cannot be performed through the remote control unit	119
Display on this unit shows nothing	120
No sound comes out	120
Sound is interrupted or noise occurs	121
Desired sound does not come out	122
AirPlay cannot be played back	123
USB flash drives cannot be played back	124
Bluetooth cannot be played back	125
The Internet radio cannot be played back	127
Music files on PC or NAS cannot be played back (Music server)	128
Various online services cannot be played	129
Cannot connect to a wireless LAN network	129
Music files on PC or Mac cannot be played back (USB-DAC)	130
Audio from digital devices cannot be played back (HDMI ARC/Coaxial/Optical 1/2)	131
The input source switches to "HDMI", "Optical 1", "Optical 2" or "Coaxial"	131
The HDMI control function does not work	131
Update/upgrade error messages	132



Resetting network settings	133
Factory Restore	134

Appendix

Playing back a USB flash drives	135
Digital input	136
Playing back a Bluetooth device	137
Playing back files stored on a PC and NAS	138
Playing back Internet Radio	140
Last function memory	140
About HDMI	141
Explanation of terms	142
Trademark information	146
Specifications	148
Index	153









Thank you for purchasing this Marantz product.

To ensure proper operation, please read this owner's manual carefully before using the product.

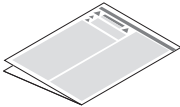
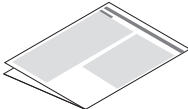
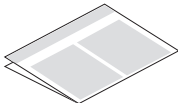
After reading this manual, be sure to keep it for future reference.

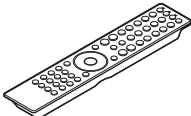
Accessories

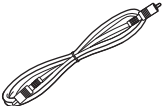
Check that the following parts are included with the product.

 <p>Quick Start Guide</p>	 <p>Safety Instructions</p>	 <p>Notes on radio</p>	 <p>Warranty (for North America model only)</p>
 <p>Power cord</p>	 <p>Remote control unit (RC004PMND)</p>	 <p>2x R03/AAA batteries</p>	 <p>Audio cable</p>
 <p>Remote connector cable</p>	 <p>External antennas for Bluetooth/wireless connectivity</p>		



Inserting the batteries

- 1 Remove the rear lid in the direction of the arrow and remove it.

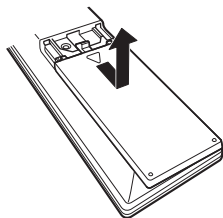

- 2 Insert two batteries correctly into the battery compartment as indicated.

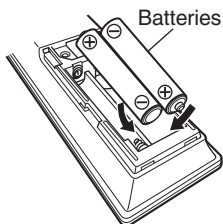

- 3 Put the rear lid back on.

NOTE

- To prevent damage or leakage of battery fluid:
 - Do not use a new battery together with an old one.
 - Do not use two different types of batteries.
- Remove the batteries from the remote control unit if it will not be in use for long periods.
- If the battery fluid should leak, carefully wipe the fluid off the inside of the battery compartment and insert new batteries.

Operating range of the remote control unit

Point the remote control unit at the remote sensor when operating it.

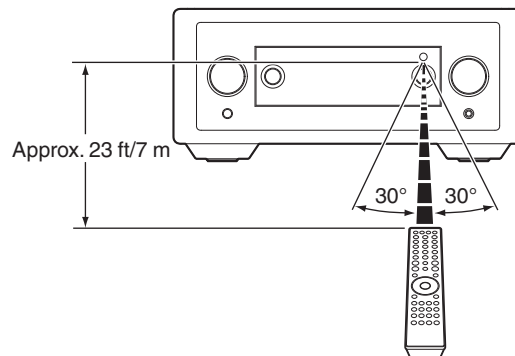

Part names and functions

Front panel

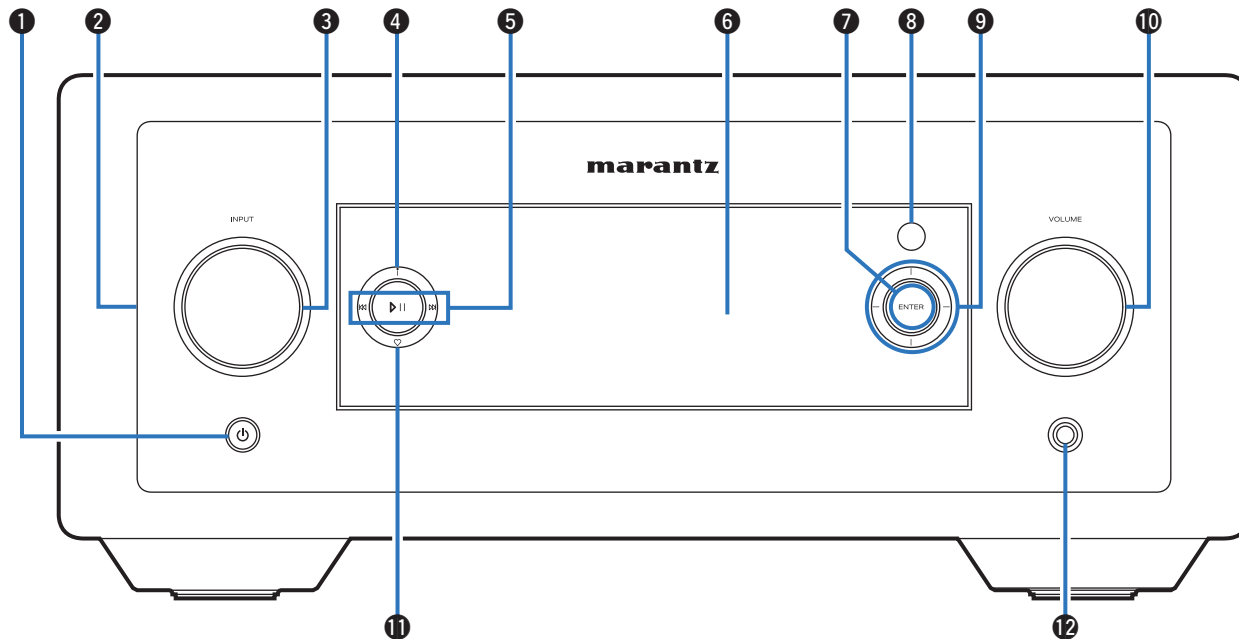

For details, see the next page.



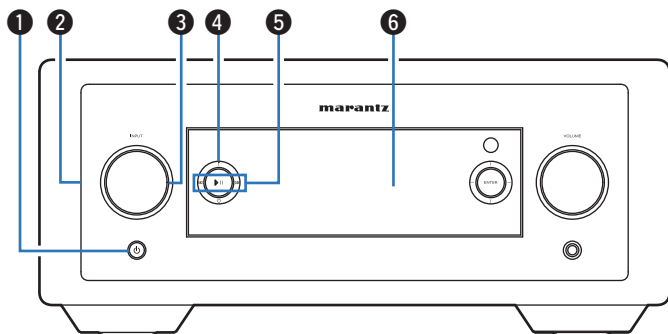

1 Power (⏻) button/indicator

- This turns the power on/off (standby). (👉 p. 42)
- This is lit as follows according to the power status:
 - Power on : White
 - Standby : Off
 - When the protection circuit is activated : Orange (blinking)

2 Illumination

This illuminates when the power is turned on. Brightness can be changed and lighting turned off.

- “Turning the illumination and display on/off” (👉 p. 91)
- “Illumination” (👉 p. 103)

3 INPUT selector knob

This selects the input source. (👉 p. 43)

4 Information button (i)

This switches the contents information shown in the display during playback.

5 System buttons

These perform playback related operations.

- Play/Pause button (⏮)
 - Press this button to pause during playback. If pressed while paused or stopped, resumes playback.
- Forward-skip button (⏭)
- Reverse-skip button (⏪)
- Press this button during playback to play the next track.
- Press this button during playback to restart the current track or play the previous track.



- Depending on the input source and online service, the operation cannot be performed.

6 Display

This displays various pieces of information.

NOTE

- The display used in this unit is made with highly advanced technology, however, there may be some dots that do not light up or light up constantly. Please note that this is not a malfunction.



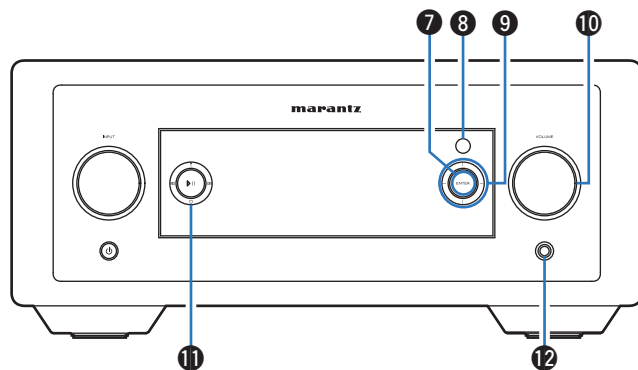

7 ENTER button

This determines the selection.

8 Remote control sensor

This receives signals from the remote control unit. (👉 p. 8)

9 Cursor buttons

These select items.

10 VOLUME knob

These adjust the volume level. (👉 p. 43)

11 Favorites button (♥)

This allows you to call “HEOS Favorites” registered content. (👉 p. 88)

12 Headphones jack

Used to connect headphones.

When the headphones are plugged into this jack, audio will no longer be output from the PREAMP OUT connectors.

NOTE

- To prevent hearing loss, do not raise the volume level excessively when using headphones.



Rear panel

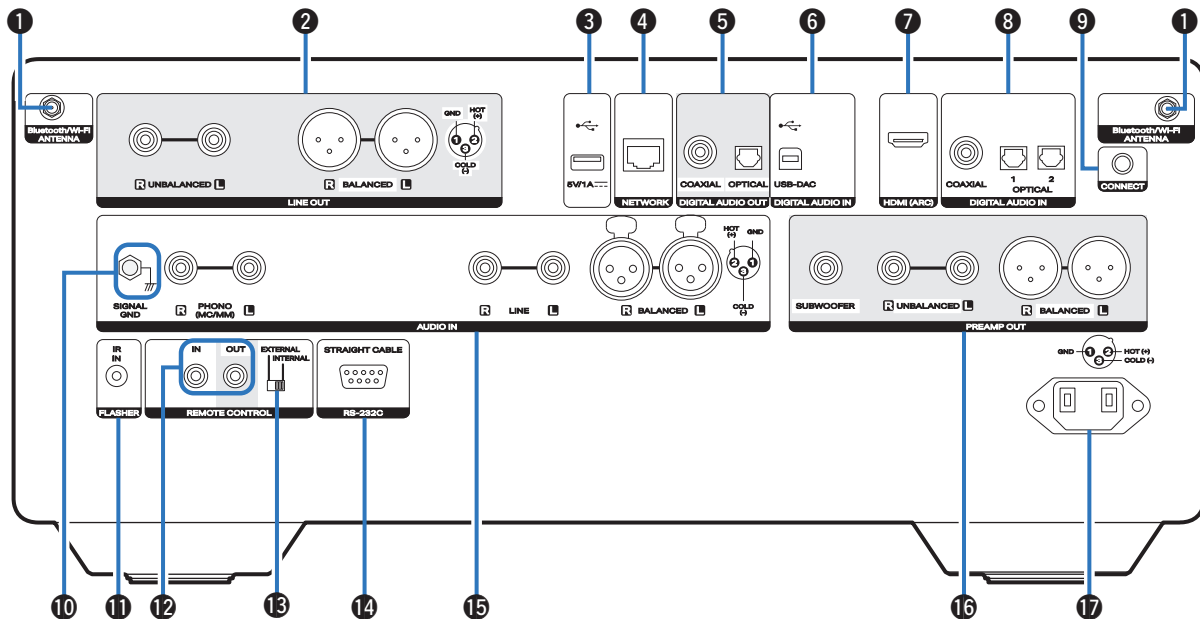

For details, see the next page.



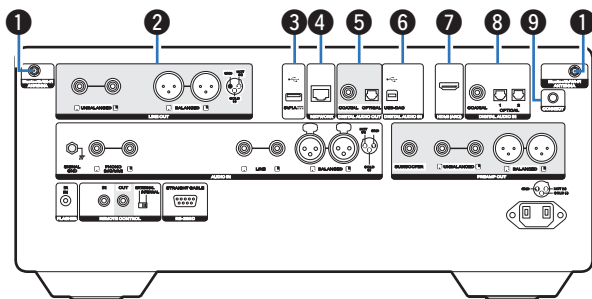

1 Bluetooth/wireless LAN antenna connectors

Used to connect the included external antennas for Bluetooth/wireless connectivity when connecting to a network via wireless LAN, or when connecting to a handheld device via Bluetooth. (☞ p. 36)

- ① Place the external antennas for Bluetooth/wireless connectivity evenly over the screw terminal of rear.
- ② Turn clockwise until the antennas is fully connected.
- ③ Rotate the antenna upwards for best reception.

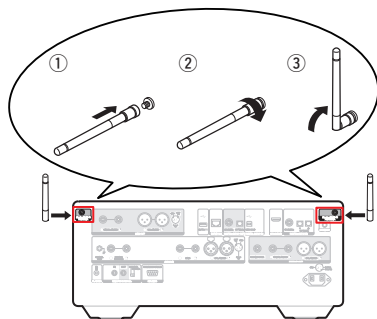

2 LINE OUT connectors

Used to connect devices equipped with analog audio inputs connectors. (☞ p. 22)

3 USB port (☞)

This is used to connect USB storages (such as USB flash drives). (☞ p. 34)

4 NETWORK connector

Used to connect to a LAN cable when connecting to a wired LAN network. (☞ p. 35)

5 DIGITAL AUDIO OUT connectors

Used to connect an amplifier or D/A converter that has a digital input connectors. (☞ p. 31)

6 DIGITAL AUDIO IN connectors (USB-DAC)

- Used to connect a computer. (☞ p. 33)

7 HDMI connector (HDMI (ARC))

Used to connect an ARC function-compatible TV. (☞ p. 27)

8 DIGITAL AUDIO IN connectors (COAXIAL/OPTICAL)

- Used to connect a TV with an optical or coaxial digital terminal. (☞ p. 29)
- Used to connect devices equipped with digital audio output connectors. (☞ p. 32)

9 CONNECT button

Used for Wi-Fi setup. (☞ p. 109)



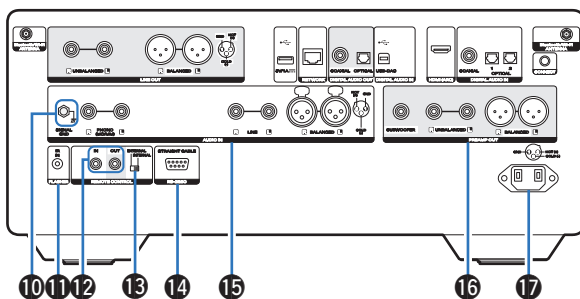

10 SIGNAL GND terminal

Used to connect a ground wire for the turntable. (☞ p. 25)

11 FLASHER IR IN jack

Used to connect a control box, etc. (☞ p. 37)

12 REMOTE CONTROL connectors

Used to connect to a Marantz audio device that is compatible with the remote control function. (☞ p. 38)

13 EXTERNAL/INTERNAL switch

Turn this switch to “INTERNAL”, this unit receives the remote control signal and the Marantz audio device connected to this unit using the remote control connection operates by receiving the remote control signal from this unit. (☞ p. 38)

14 RS-232C connector

Used to connect home automation controller devices fitted with RS-232C connectors. Consult the owner’s manual of the home automation controller for more information about serial control of this unit.

Perform the operation below beforehand.

- ① Turn on the power of this unit.
- ② Turn off the power of this unit from the external controller.
- ③ Check that the unit is in the standby mode.

15 Analog audio input connectors (AUDIO IN)

Used to connect devices equipped with analog audio output connectors. (☞ p. 25)

16 PREAMP OUT connectors

Use this to add such equipment as a power amplifier or subwoofer.

- “Connecting an amplifier” (☞ p. 22)
- “Connecting the subwoofer” (☞ p. 24)



- When connecting a subwoofer, also consult the subwoofer instruction manual.

17 AC inlet (AC IN)

Used to connect the power cord. (☞ p. 40)



Remote control unit

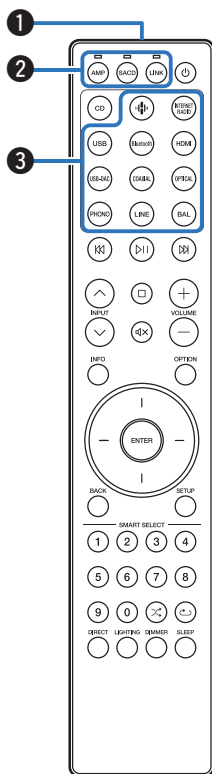

The remote control provided with this unit can control a Marantz amplifier and SACD player.

- “Amplifier operations” (☞ p. 19)
- “SACD player operations” (☞ p. 20)

■ Operating this unit

To operate this unit, press LINK button to switch the remote control operating mode to this unit.

❶ Remote control signal transmitter

This transmits signals from the remote control unit. (☞ p. 8)

❷ Remote mode select buttons/indicators (AMP/SACD/LINK)

- These switch the remote control operating mode (AMP/SACD/LINK).
- The indicator will light up according to the device being operated.

❸ Input source select buttons

These select the input source. (☞ p. 43)



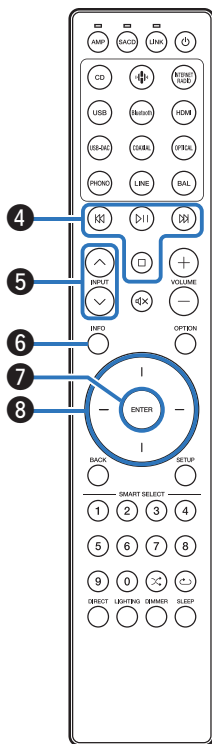

4 System buttons

These perform playback related operations.

- Play/Pause button (⏪)

Press this button to pause during playback. If pressed while paused or stopped, resumes playback.

- Forward-skip button (⏭)

Press this button during playback to play the next track.

- Reverse-skip button (⏮)

Press this button during playback to restart the current track or play the previous track.

- Stop button (⏹)

Press this button to stop during playback.



- Depending on the input source and online service, the operation cannot be performed.

5 INPUT buttons (⏪ ⏩)

This selects the input source. (🔍 p. 43)

6 Information button (INFO)

This switches the contents information shown in the display during playback.

7 ENTER button

This determines the selection.

8 Cursor buttons

These select items.

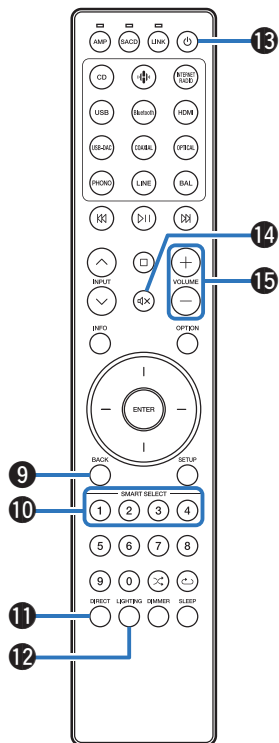

**9 BACK button**

Returns to the previous item.

10 SMART SELECT buttons (1 - 4)

These call up settings registered to each button, such as input source, volume level, source direct settings and tone settings in the option menu. (☞ p. 93)

11 DIRECT button

This turns source direct mode on/off. (☞ p. 90)

12 LIGHTING button

This turns the illumination and display on/off. (☞ p. 91)

13 Power (⏻) button

This turns the power on/off (standby). (☞ p. 42)

14 Mute button (⏻)

This mutes the output audio. (☞ p. 44)

15 VOLUME buttons (+/-)

These adjust the volume level. (☞ p. 43)



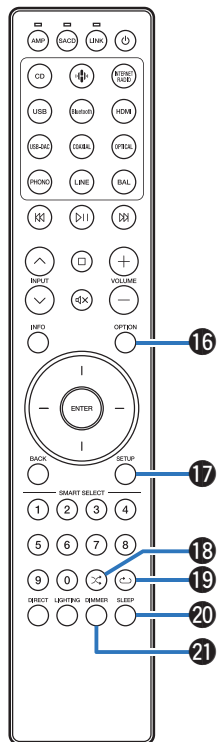

16 OPTION button

- This displays the option menu on the display.



- An option menu is not displayed for some input sources.

17 SETUP button

The setting menu is displayed on the display. (👉 p. 96)

18 Random button (X)

Switches the random playback.

19 Repeat button (↺)

Switches the repeat playback.

20 SLEEP button

This sets the sleep timer. (👉 p. 92)

21 DIMMER button

Adjust the display brightness of this unit. (👉 p. 91)



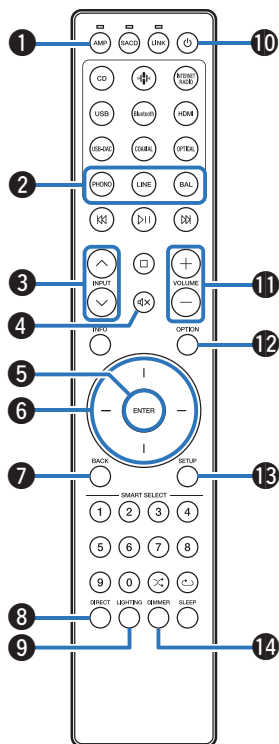

Amplifier operations

A Marantz amplifier can be operated.

To operate amplifier, press AMP button to switch the remote control to the amplifier operation mode.

- 1 Remote mode select button (AMP)
- 2 Input source select buttons (PHONO/LINE/BAL)
- 3 INPUT buttons (^/v)
- 4 Mute button (M)
- 5 ENTER button
- 6 Cursor buttons
- 7 BACK button
- 8 DIRECT button
- 9 LIGHTING button
- 10 Power (P) button
- 11 VOLUME buttons (+/-)
- 12 OPTION button
- 13 SETUP button
- 14 DIMMER button



- The remote control may not operate some products.



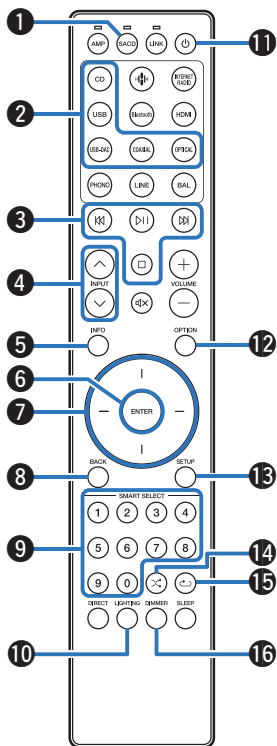

■ SACD player operations

A Marantz SACD player can be operated.

To operate SACD player, press SACD button to switch the remote control to the SACD player operation mode.

- 1 Remote mode select button (SACD)
- 2 Input source select buttons
- 3 System buttons
- 4 INPUT buttons (↕)
- 5 Information button (INFO)
- 6 ENTER button
- 7 Cursor buttons
- 8 BACK button
- 9 Number buttons (0 – 9)
- 10 LIGHTING button
- 11 Power (⏻) button
- 12 OPTION button
- 13 SETUP button
- 14 Random button (X)
- 15 Repeat button (↺)
- 16 DIMMER button



- The remote control may not operate some products.



■ Contents











Connecting an amplifier	22
Connecting the subwoofer	24
Connecting a playback device	25
Connecting a TV	27
Connecting to a device with digital audio input connectors	31
Connecting to a device with digital audio output connectors	32
Connecting a PC or Mac	33
Connecting a USB flash drive to the USB port	34
Connecting to a home network (LAN)	35
Connecting an external control device	37
Connecting the power cord	40

NOTE

- Do not plug in the power cord until all connections have been completed.
- Do not bundle power cords with connection cables. Doing so can result in humming or noise.

■ Cables used for connections

Provide necessary cables according to the devices you want to connect.

Audio cable (included)	
Balance cable (not included)	
Subwoofer cable (not included)	
Remote connector cable (included)	
HDMI cable (not included)	
Optical cable (not included)	
Coaxial digital cable (not included)	
USB cable (not included)	
LAN cable (not included)	
Monaural mini-plug cable (not included)	



Connecting an amplifier

Connect the amplifier to the LINE OUT connectors of this unit. You can also use this unit as a pre-amplifier by connecting a power amplifier to the PREAMP OUT connectors.

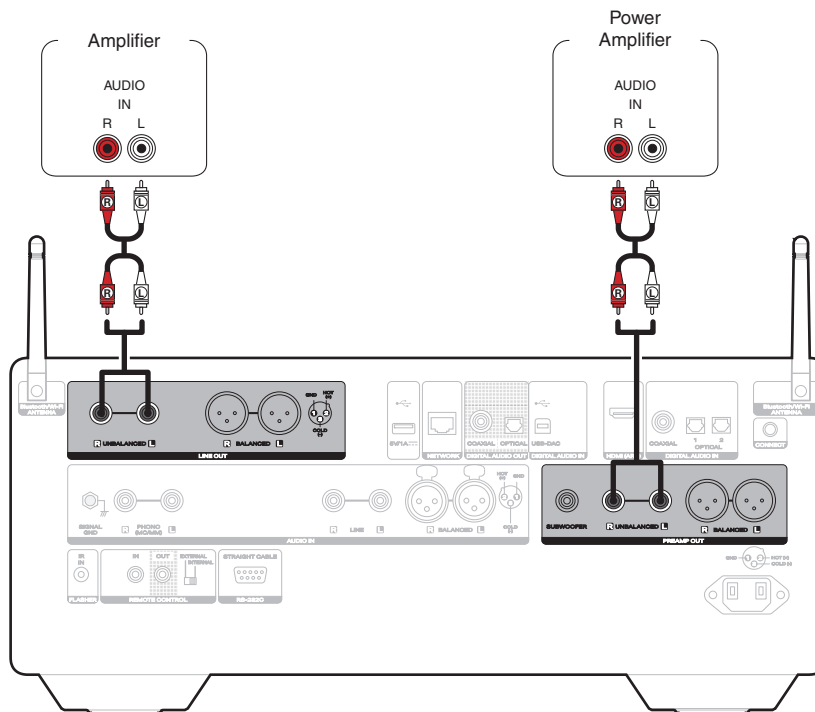

■ About balanced connectors

This unit has both unbalanced and balanced connectors. The balanced connectors have three pins, making it possible to transmit audio signals as a balanced signal, reducing the effect of external noise. They also have a removable lock mechanism, which reduces shaking in the connector area, making the connection highly reliable.



- The balanced connection is an all-stage balanced configuration.

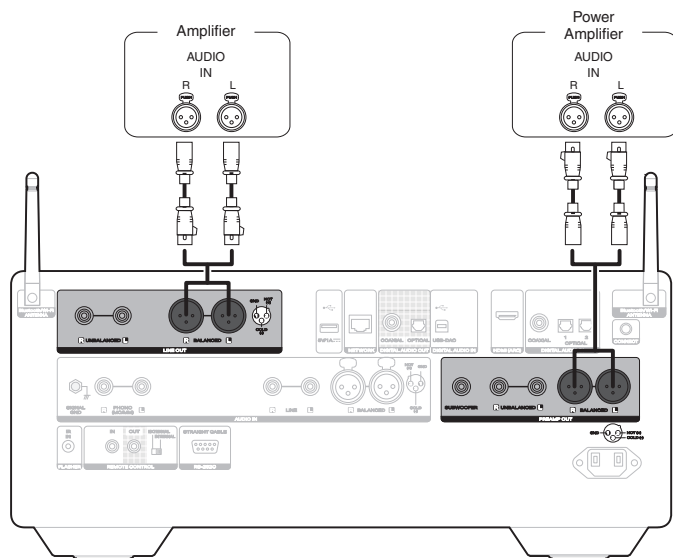

■ Phases of the balanced connectors

The XLR connector is internally wired in either of the following two systems. This unit employs the European system.

- European system (② PIN=HOT / ③ PIN=COLD)

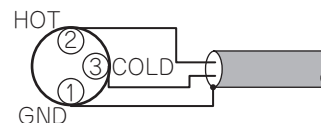

- USA system (② PIN=COLD / ③ PIN=HOT)

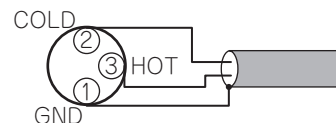

If a product that employs the USA system is connected with this unit via a balanced cable, the output signal may be phase-inverted. To correct the inversion, connect the one side XLR connector reversing the ② PIN and ③ PIN.



Connecting the subwoofer

Use a subwoofer cable to connect the subwoofer.

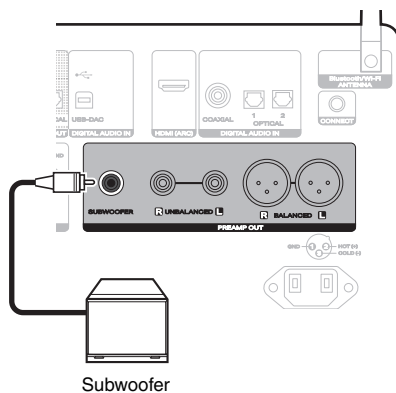

Connecting a playback device

You can connect turntables and CD players to this unit. Set the phono equalizer of this unit in the “Phono” section of the setting menu according to the type of turntable cartridge to be connected. (🔧 p. 100)

If you set this unit’s input source to “Phono” and you accidentally increase the volume without having a turntable connected, you may hear a hum noise from the speakers.

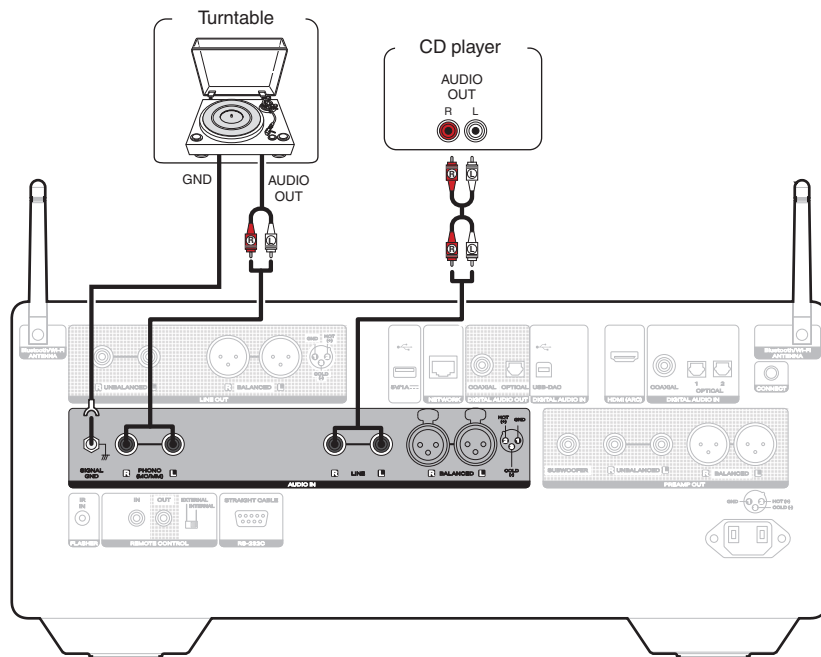

NOTE

- The earth terminal (SIGNAL GND) of this unit is not for safety grounding purposes. If this terminal is connected when there is a lot of noise, the noise can be reduced. Note that depending on the turntable, connecting the ground line may have the reverse effect of increasing noise. In this case, it is not necessary to connect the ground line.



- The PHONO input terminals are equipped with a short-circuiting pin-plug. Remove this plug to connect a record player. Store the removed short-circuiting pin-plug in a safe place so as not to lose it.



■ About balanced connectors

This unit has both unbalanced and balanced connectors. The balanced connectors have three pins, making it possible to transmit audio signals as a balanced signal, reducing the effect of external noise. They also have a removable lock mechanism, which reduces shaking in the connector area, making the connection highly reliable.



- The balanced connection is an all-stage balanced configuration.

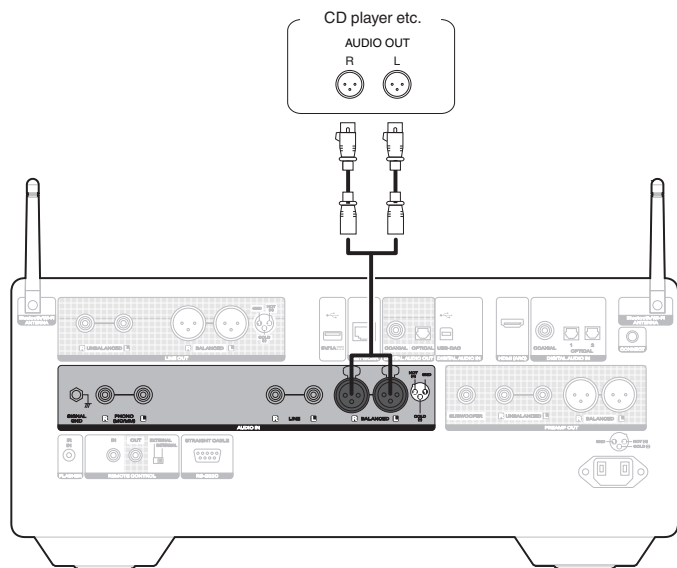

■ Phases of the balanced connectors

The XLR connector is internally wired in either of the following two systems. This unit employs the European system.

- European system (② PIN=HOT / ③ PIN=COLD)

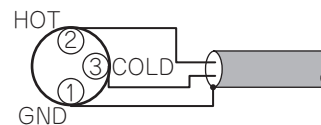

- USA system (② PIN=COLD / ③ PIN=HOT)

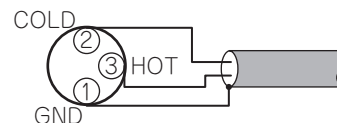

If a product that employs the USA system is connected with this unit via a balanced cable, the output signal may be phase-inverted. To correct the inversion, connect the one side XLR connector reversing the ② PIN and ③ PIN.



Connecting a TV

This unit can be connected to a TV for high-quality playback of the TV audio.

Connecting this unit to the HDMI ARC terminal on a TV

If the HDMI terminal on your TV supports ARC, connect with HDMI.

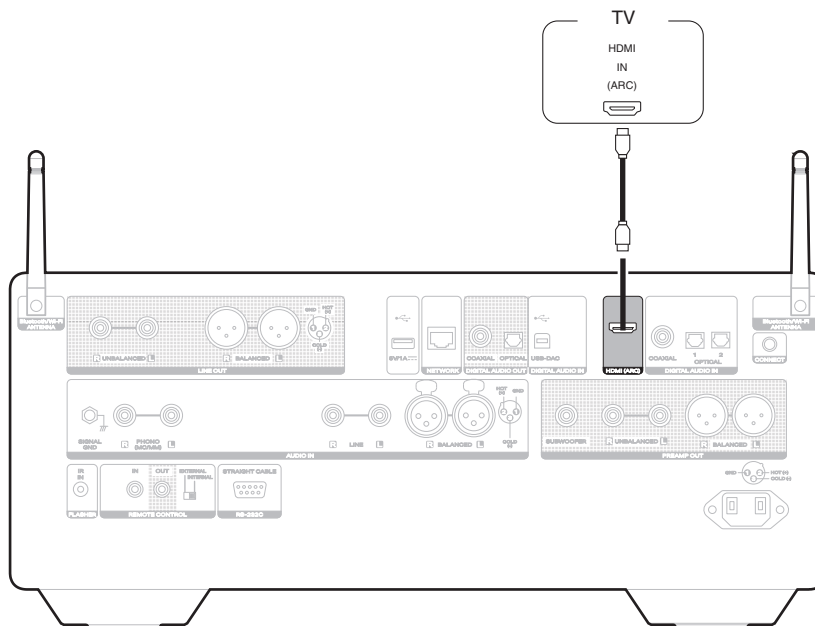



- When connecting a TV to this unit, turn off the audio output of the TV's internal speakers. See the owner's manual of your TV for details.
- When connecting the HDMI (ARC) terminal of this device to your TV, connect it to the HDMI input terminal of your TV that supports the ARC function.
- When connecting to a TV that does not support the ARC function, use an Optical connection or a Coaxial connection to play the TV audio. (👉 p. 29)
- While using HDMI ARC for TV connection it is highly recommended for the best volume control experience to use the PREAMP OUT connectors from this unit to connect to the amplifier. (👉 p. 22)

NOTE

- Only the PCM 2-channel setting can be used to play sound from a TV via the HDMI ARC function. Set "PCM 2ch" as the audio format in the TV settings.
- Linear PCM signals with a sampling frequency of 32 kHz, 44.1 kHz, 48 kHz, 88.2 kHz, 96 kHz, 176.4 kHz, or 192 kHz can be input into this unit.
- Do not input non-PCM signals, such as Dolby Digital, DTS and AAC. This causes noise and could damage the speakers.

■ Specifications of supported audio formats

See "Digital input" (👉 p. 136).



Connecting this unit to the Optical or Coaxial terminal on a TV

If the HDMI terminal on your TV does not support ARC or your TV does not have any HDMI terminals, connect with an optical cable or a coaxial digital cable.

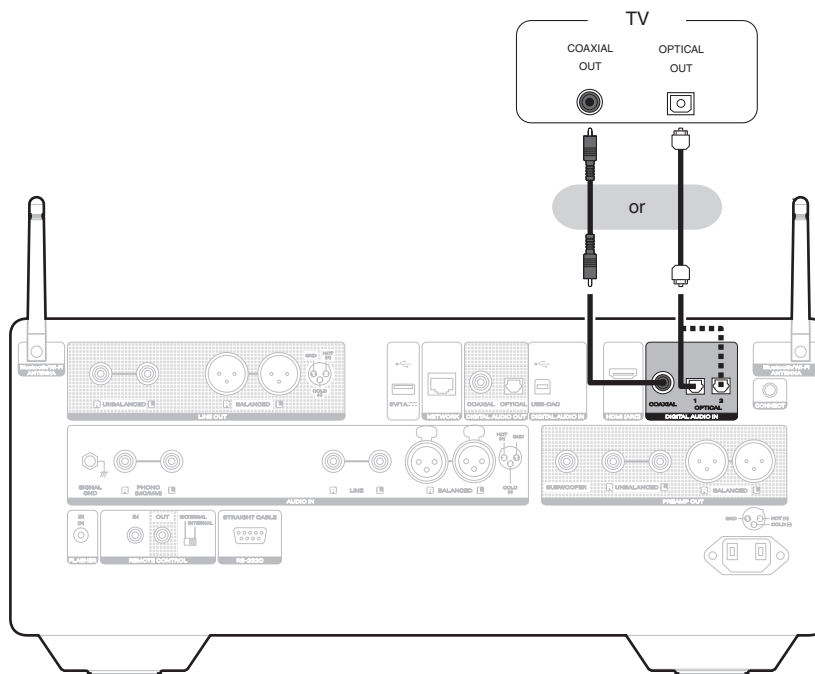



- When connecting a TV to this unit, turn off the audio output of the TV's internal speakers. See the owner's manual of your TV for details.

NOTE

- Linear PCM signals with a sampling frequency of 44.1 kHz, 48 kHz, 88.2 kHz, 96 kHz, 176.4 kHz, or 192 kHz can be input into this unit.
- Do not input non-PCM signals, such as Dolby Digital, DTS and AAC. This causes noise and could damage the speakers.

■ Specifications of supported audio formats

See "Digital input" (🔍 p. 136).



Connecting to a device with digital audio input connectors

You can enjoy digital audio playback by connecting an amplifier or D/A converter that has a digital audio connector to this unit.

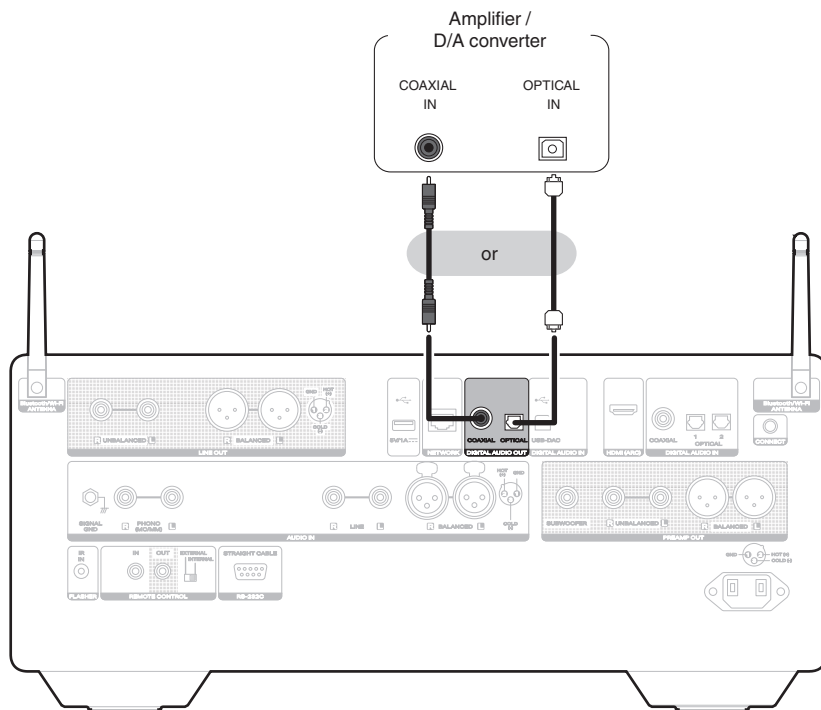

NOTE

- Digital audio output stops during playback of the DSD signals and linear PCM signals with a sampling frequency of 352.8/384 kHz using this unit's USB-DAC.
- Digital audio output stops during playback of the DSD files and sampling frequency of 352.8/384 kHz files via USB and networks.
- Digital audio output can be set on/off using "Digital Out" in the setup menu. (p. 99)
- Digital audio output stops during playback of the analog input.



Connecting to a device with digital audio output connectors

Use this connection to input digital audio signals to this unit, and convert the signals for playback using the D/A converter of this unit. (🔗 p. 70)

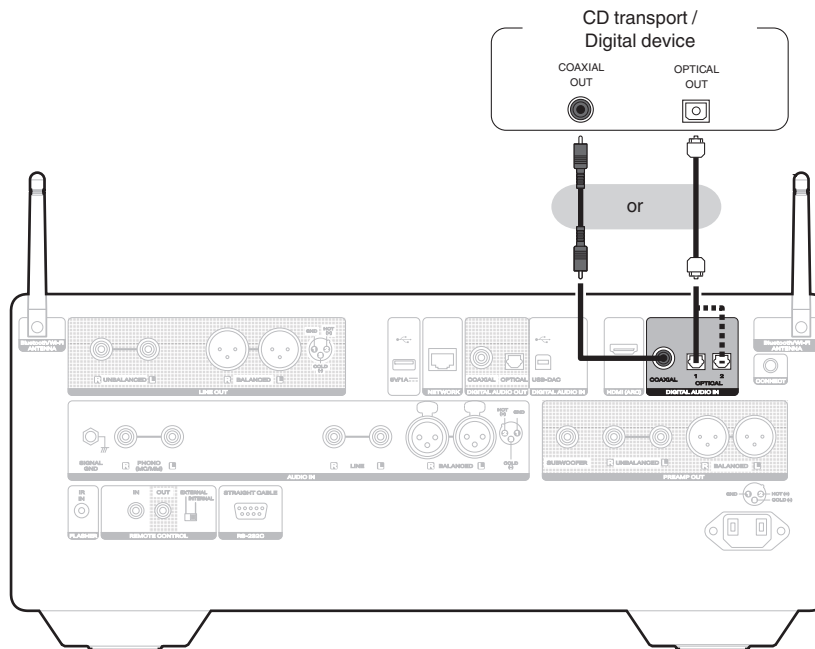

■ Specifications of supported audio formats

See “Digital input” (🔗 p. 136).



Connecting a PC or Mac

By connecting a computer to the USB-DAC port on the rear panel of this unit using a commercially available USB connecting cable, this unit can be used as a D/A converter. (🔍 p. 72)

NOTE

- Before USB connecting this unit to your computer, install the driver software in your computer. (🔍 p. 72)
- Download the driver software from the LINK 10n page of the Marantz website.
- Use a cable that is 10 ft (3 m) or less to connect to the computer.

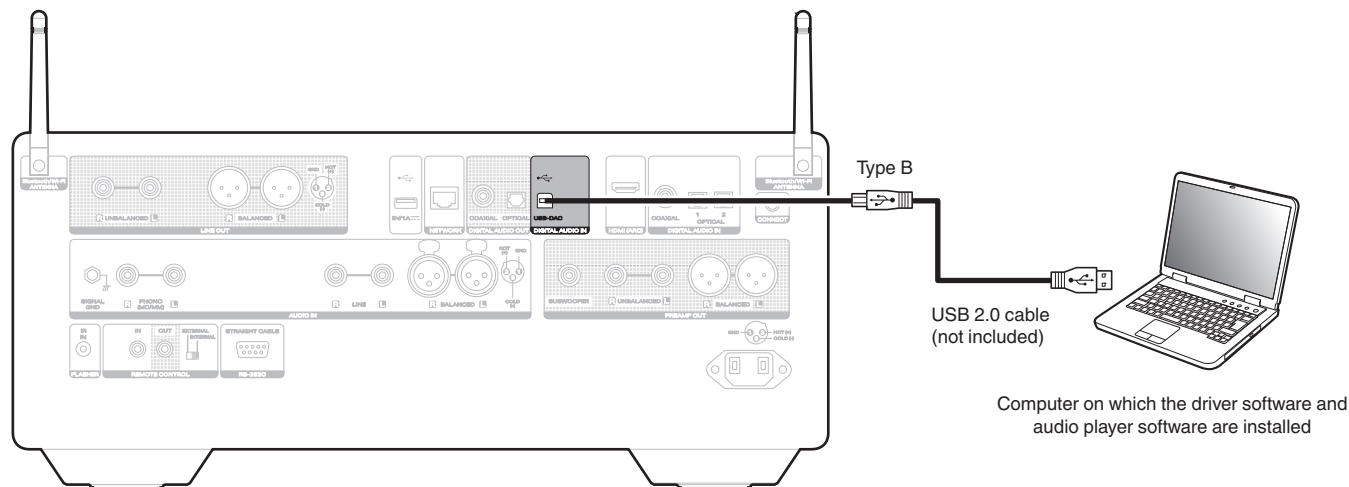

Connecting a USB flash drive to the USB port

For operating instructions see “Playing a USB flash drive” (📖 p. 50).

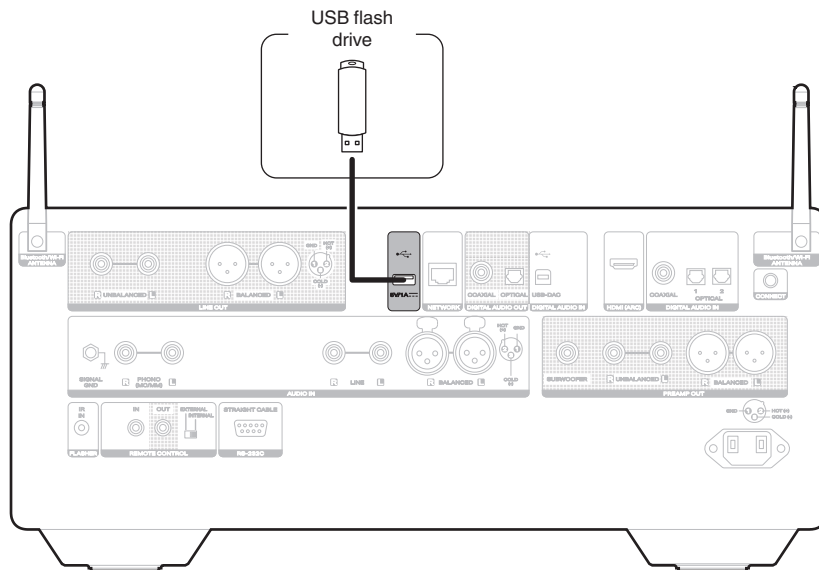

- Marantz does not guarantee that all USB flash drives will operate or receive power. When using a portable USB hard disk drive (HDD) which came with an AC adapter, use that device's included AC adapter.

NOTE

- USB flash drives will not work via a USB hub.
- It is not possible to use this unit by connecting the rear panel's USB port to a computer via a USB cable. Connection to a computer is possible via the digital input USB-DAC port (Type B) on the rear panel.
- Do not use an extension cable when connecting a USB flash drive. This may cause radio interference with other devices.



Wireless LAN

When connecting to the network via wireless LAN, connect the external antennas for Bluetooth/wireless connectivity connection to the rear panel and stand them upright.

To connect to a wireless LAN router, download the HEOS app to your smartphone, and set up this unit. (☞ p. 60)

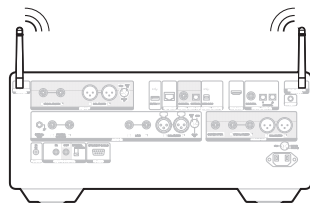
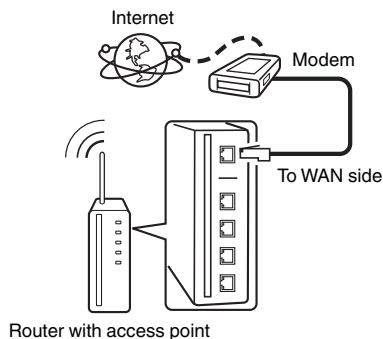

- When using this unit, we recommend you use a router equipped with the following functions:
 - Built-in DHCP server
This function automatically assigns IP addresses on the LAN.
 - Built-in 100BASE-TX switch
When connecting multiple devices, we recommend a switching hub with a speed of 100 Mbps or greater.
- Only use a shielded STP or ScTP LAN cable (readily available at electronics stores). (CAT-5 or greater recommended)
- The normal shielded-type LAN cable is recommended. If a flat-type cable or unshielded-type cable is used, other devices could be affected by noise.

NOTE

- The types of routers that can be used depend on the ISP. Contact your ISP or a computer shop for details.
- This unit is not compatible with PPPoE. A PPPoE compatible router is required if your contracted line is not set using PPPoE.
- Do not connect a NETWORK connector directly to the LAN port/ Ethernet connector on your computer.
- Various online services may be discontinued without prior notice.



Connecting an external control device

FLASHER IN jack

This unit can be controlled by connecting a control box or other control device to this unit.

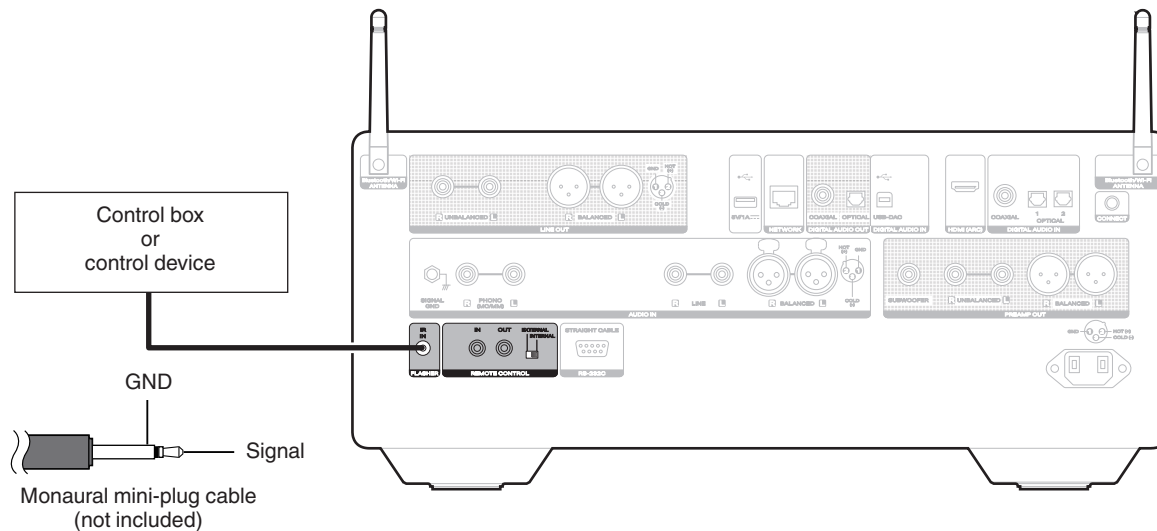

- To use the FLASHER IN jack, set the EXTERNAL/INTERNAL switch to "INTERNAL".



REMOTE CONTROL connectors

When this unit is connected in combination with MODEL 10 and SACD 10, the following functions will be available.

- Controlling MODEL 10 through this unit using the HEOS app
- Controlling MODEL 10 through this unit, using the TV remote control (HDMI control function)
- Synchronizing the power on/standby operations of this unit and MODEL 10 or SACD 10



- You can also use the power linkage function by combining this unit with a Marantz amplifier.
- Some operations may not be possible on some Marantz amplifiers.
- It may not be possible to control the volume with the TV remote control (HDMI control function) depending on the Marantz amplifier and TV connected to this unit.
- When controlling a Marantz amplifier that has a remote control code (AMP 1 – 3) setting function from this unit, set the remote control code of the amplifier to “AMP 1”.

Next, configure the “Connection” and “Setting”.

■ Connection

Use the included remote connector cable to connect the REMOTE CONTROL OUT connector of this unit to REMOTE CONTROL IN connector of MODEL 10 or SACD 10.

■ Setting

For the best way to adjust the the volume using the HDMI ARC function of the TV, configure the following settings.

1. Turn the EXTERNAL/INTERNAL switch on this unit to “INTERNAL”.
2. Turn the EXTERNAL/INTERNAL switch on MODEL 10 or SACD 10 to “EXTERNAL”.

- This setting will disable remote sensor reception of MODEL 10 or SACD 10.
- To operate the unit, point the remote control at the remote sensor of this unit.



- To use this unit by itself without connecting MODEL 10 or SACD 10, turn the switch to “INTERNAL”.



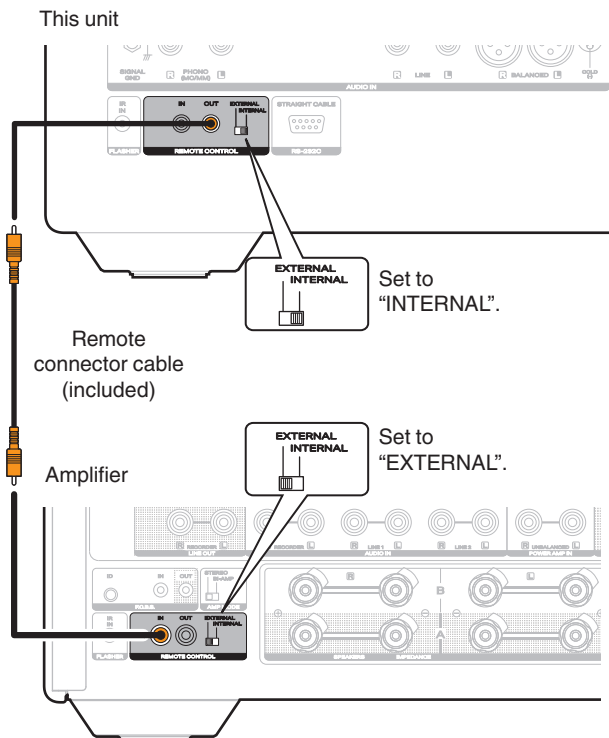

NOTE

- When connecting a Marantz amplifier that does not have the EXTERNAL/INTERNAL switch on the rear panel, configure the following settings.
 1. Turn the EXTERNAL/INTERNAL switch on this unit to "EXTERNAL".
 - This setting will disable remote sensor reception of this unit.
 - To operate the unit, point the remote control at the remote sensor of the amplifier.
- When connecting an amplifier that can be set to "Disable" on the remote sensor reception function, configure the following settings.
 1. Turn the EXTERNAL/INTERNAL switch on this unit to "INTERNAL".
 2. Set the remote sensor reception function to "Disable".
 - This setting will disable remote sensor reception of this amplifier.
 - To operate the unit, point the remote control at the remote sensor of this unit.



Connecting the power cord

After completing all the connections, insert the power plug into the power outlet.

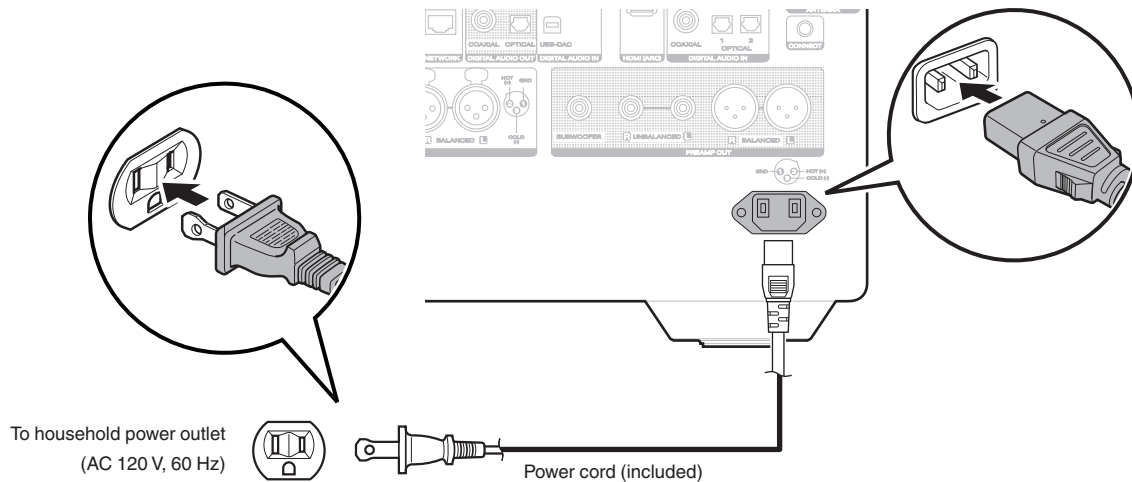

■ Contents

Basic operation

Turning the power on	42
Switching the power to standby	42
Selecting the input source	43
Adjusting the volume	43
Turning off the sound temporarily (Muting)	44

Playback network audio/service

Listening to Internet Radio	45
Playing back files stored on PC or NAS	47
Getting the HEOS app	60
AirPlay function	83
Spotify Connect function	86

Playback a device

Playing a USB flash drive	50
Listening to music on a Bluetooth device	53
Listening to audio on Bluetooth headphones	57
Playing digital input	70
Playing analog input	82

Convenience functions

Playing back HEOS Favorites	88
Adding to HEOS Favorites	88
Deleting a HEOS Favorites	89
Adjusting the tone and balance	89
Playback in source direct mode	90
Switching the display's brightness	91
Turning the illumination and display on/off	91
Using the sleep timer	92
Displaying the volume at all times (When "Preamp Out" is set to "On")	92
Smart select function	93



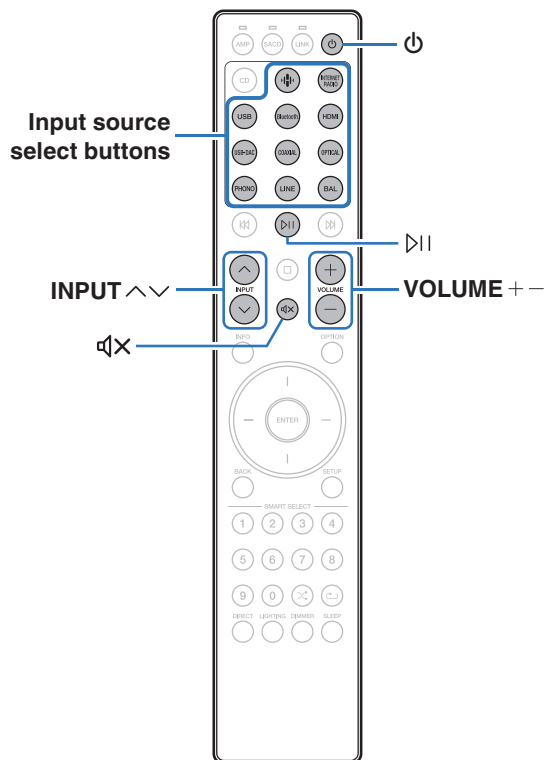

Basic operation



Turning the power on

1 Press  to turn on power to the unit.



- You can also press  on the main unit to turn on power from standby mode.
- You can also press  to turn on power from standby mode.

Switching the power to standby

1 Press .

The unit switches to standby mode.



- You can also switch the power to standby by pressing  on the main unit.

NOTE

- Power continues to be supplied to some of the circuitry even when the power is in the standby mode. When leaving home for long periods of time or when going on vacation, unplug the power cord from the power outlet.



Selecting the input source

1 Press the input source select button to be played back.

The selected input source appears on the display.



- You can also select the input source by using INPUT \wedge \vee .
- If you press the  (HEOS Music) button, the input source is switched to the one that was previously played on the network. If you cannot access the input source that was previously played from on the network, open "HEOS" on the display.
- If you playback from the HEOS app when the power of this device is on, it automatically switches to the input source that is playing.
- This unit switches between Optical 1 and Optical 2 each time OPTICAL is pressed.
- You can also select the input source by turning INPUT selector on the main unit.



Adjusting the volume

Adjusts the volume of the audio signal output from the PREAMP OUT connectors and the headphones jack.

1 Use VOLUME \pm to adjust the volume.

The volume level appears on the display.



- You can also adjust the volume by turning VOLUME on the main unit.
- You can change how the volume level is displayed. ( p. 99)
- You can adjust the volume of the audio signal output from the PREAMP OUT connectors when "Preamp Out" is set to "On". ( p. 98)





Turning off the sound temporarily (Muting)

Mute the audio signal output from the PREAMP OUT connectors and the headphones jack.

1 Press .

“Mute” is displayed on the display.



- To cancel mute, either adjust the sound volume or press  again.
- You can mute the audio signal output from the PREAMP OUT connectors when “Preamp Out” is set to “On”. ( p. 98)



Listening to Internet Radio

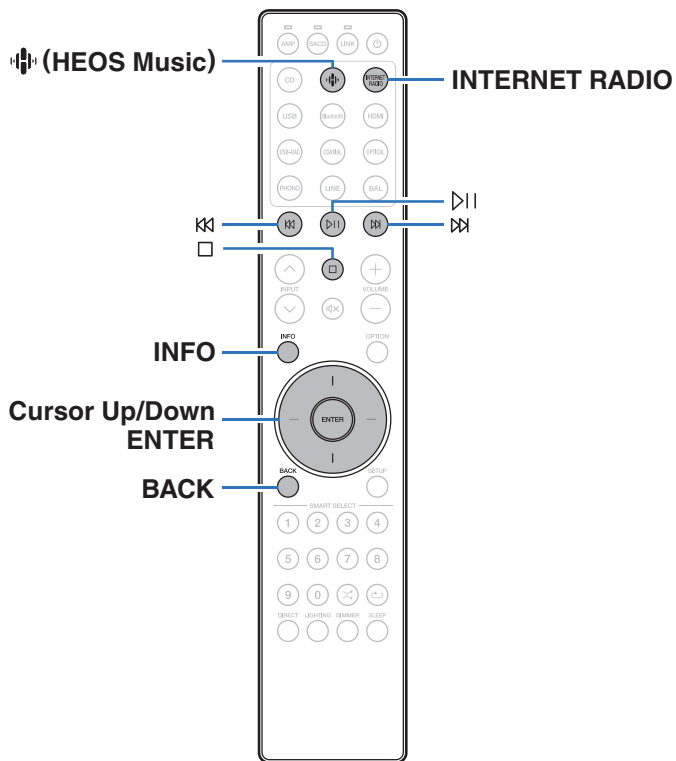

- Internet Radio refers to radio broadcasts distributed over the Internet. Internet Radio stations from around the world can be received.
- The Internet Radio station list on this unit the database service provided by TuneIn Radio service.
- The audio format types and specifications supported by this unit for playback are as follows.
See “Playing back Internet Radio” (👉 p. 140) for details.

- WMA
- MP3
- MPEG-4 AAC





Listening to Internet Radio

1 Press INTERNET RADIO.

- You can also press  (HEOS Music). Use Cursor Up/Down buttons to select "Internet Radio", then press ENTER.

2 Select the station you want to play.

Operation buttons	Function
 *	Playback / Pause
	Stop
 *	Skip to previous track / Skip to next track
Cursor Up/Down	Select the item
ENTER	Enter the selected item / Playback
BACK	Moving up a level in the hierarchy
INFO	Switch to show/hide the format and quality screen

* Enabled when playing Podcasts.



- Any characters that cannot be displayed are replaced with "□".

NOTE

- The radio station database service may be suspended or be otherwise unavailable without notice.



Playing back files stored on PC or NAS

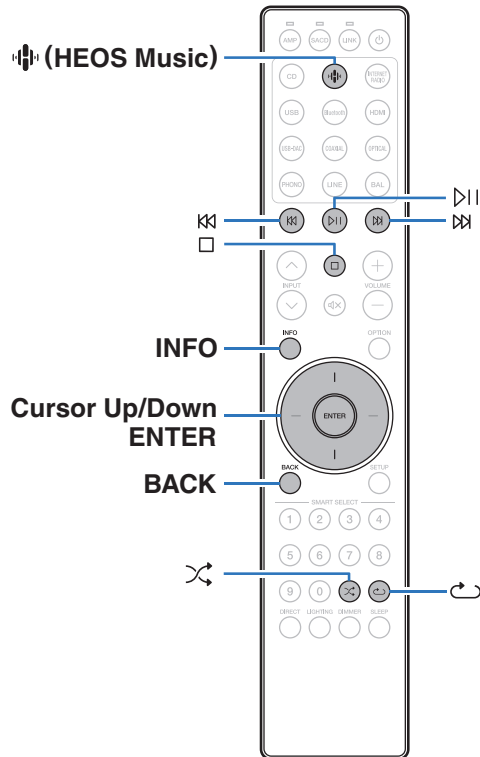

- This unit can playback music files and playlists (m3u, wpl) from DLNA compatible servers including PCs and NAS devices on your network.
- The audio format types and specifications supported by this unit for playback are as follows.
See “Playing back files stored on a PC and NAS” (p. 138) for details.

- **WMA**
- **MP3**
- **WAV**
- **MPEG-4 AAC**
- **FLAC**
- **Apple Lossless**
- **DSD**



Playing back files stored on PC or NAS

Use this procedure to play music files or playlists stored on DLNA files servers on your local network.

1 Press (HEOS Music).

If a playback history is present, the last Internet radio station or song played is played back. Pressing  (HEOS Music) again displays the HEOS Music top menu.

2 Use Cursor Up/Down buttons to select “Music Servers”, then press ENTER.

3 Select the name of your networked PC or NAS (Network Attached Storage) server.

4 Browse the music on your PC/NAS and select something to play.



- When you select something to play you will be asked how you want to queue up your music.

Play Now:	Inserts the item into the queue after the currently playing track and plays the selected item immediately.
Play Now & Replace Queue:	Clears the queue and plays the selected item immediately.
Play Next:	Inserts the item into the queue after the currently playing track and plays it when the currently playing track ends.
Add to End of Queue:	Adds the item to the end of the queue.



5 Use Cursor Up/Down buttons to select the “Play Now” or “Play Now & Replace Queue”, then press ENTER.

Playback starts.

Operation buttons	Function
▷	Playback / Pause
□	Stop
⏮ ⏭	Skip to previous track / Skip to next track
Cursor Up/Down	Select the item
ENTER	Enter the selected item
BACK	Moving up a level in the hierarchy
↺	Repeat playback <ul style="list-style-type: none"> Switching between Single-track repeat and All-track repeat
⌘	Random playback
INFO	Switch to show/hide the format and quality screen

NOTE

- When playing back music files with your PC or NAS connected through wireless LAN, audio may be interrupted depending on your wireless LAN environment. In this case, connect using a wired LAN.
- The order in which the tracks/files are displayed depends on the server specifications. If the tracks/files are not displayed in alphabetical order due to the server specifications, searching by the first letter may not work properly.



Playing files stored on USB flash drives

- 1 Insert the USB flash drive into the USB port.
- 2 Press **USB** to switch the input source to “USB Music”.
 - You can also press  (HEOS Music). Use Cursor Up/Down buttons to select “USB Music”, then press ENTER.
- 3 Select the name of this unit.

- 4 Browse the music on your USB flash drive and select something to play.



- When you select something to play you will be asked how you want to queue up your music.

Play Now:	Inserts the item into the queue after the currently playing track and plays the selected item immediately.
Play Now & Replace Queue:	Clears the queue and plays the selected item immediately.
Play Next:	Inserts the item into the queue after the currently playing track and plays it when the currently playing track ends.
Add to End of Queue:	Adds the item to the end of the queue.

- 5 Use Cursor Up/Down buttons to select the “Play Now” or “Play Now & Replace Queue”, then press ENTER. Playback starts.



Operation buttons	Function
▶	Playback / Pause
□	Stop
⏮ ⏭	Skip to previous track / Skip to next track
Cursor Up/Down	Select the item
ENTER	Enter the selected item / Playback
BACK	Moving up a level in the hierarchy
↺	Repeat playback <ul style="list-style-type: none"> • Switching between Single-track repeat and All-track repeat
⌘	Random playback
INFO	Switch to show/hide the format and quality screen

NOTE

- Note that Marantz will accept no responsibility whatsoever for any problems arising with the data on a USB flash drive when using this unit in conjunction with the USB flash drive.
- When a USB flash drive is connected to this unit, the unit loads all of the files on the USB flash drive. Loading may take a while if the USB flash drive contains a large number of folders and/or files.



Listening to music on a Bluetooth device

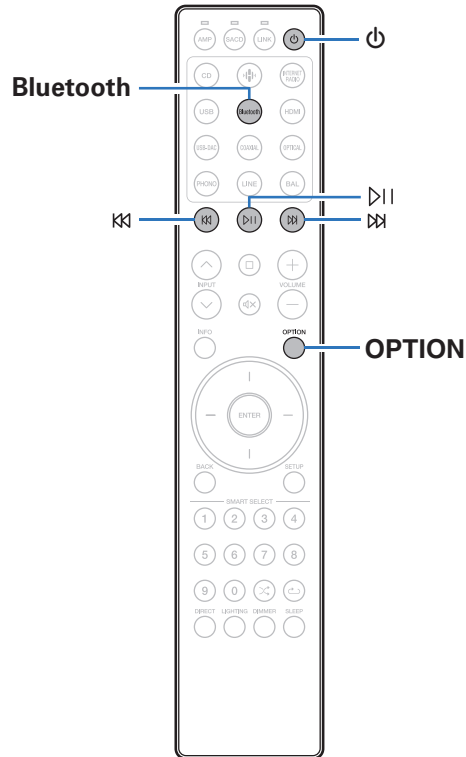

Music files stored on Bluetooth devices such as smartphones, digital music players, etc. can be enjoyed on this unit by pairing and connecting this unit with the Bluetooth device.

Communication is possible up to a range of about 98.4 ft/30 m.

NOTE

- To play back music from a Bluetooth device, the Bluetooth device needs to support the A2DP profile.



Listening to music on a Bluetooth device

In order to enjoy music from a Bluetooth device on this unit, the Bluetooth device must first be paired with this unit.

Once the Bluetooth device has been paired, it does not need to be paired again.

1 Prepare for playback.

- ① Connect the supplied external antennas for Bluetooth/wireless connectivity to the Bluetooth/wireless LAN antenna connectors on the rear panel. (☞ p. 12)
- ② Press  to turn on power to the unit.

2 Press Bluetooth.

When playing content via Bluetooth on this unit for the first time, the unit will go into the pairing mode automatically.



3 Activate the Bluetooth settings on your Bluetooth device.

4 Select this unit when its name appears in the list of devices displayed on the screen of the Bluetooth device.

Perform the connection with the Bluetooth device close to the unit (about 3.3 ft/1 m).

5 Play music using any app on your Bluetooth device.

- The Bluetooth device can also be operated with the remote control of this unit.
- The next time the Bluetooth button is pressed on the remote control unit, this unit automatically connects to the last Bluetooth device that was connected.

Operation buttons	Function
	Playback / Pause
	Skip to previous track / Skip to next track



Pairing with other Bluetooth devices

Pair a Bluetooth device with this unit.

- 1 Activate the Bluetooth settings on your Bluetooth device.**
- 2 Press and hold Bluetooth on the remote control unit for at least 3 seconds.**

This unit will go into the pairing mode.
- 3 Select this unit when its name appears in the list of devices displayed on the screen of the Bluetooth device.**



- This unit can be paired with a maximum of 8 Bluetooth devices. When a 9th Bluetooth device is paired, it will be registered in place of the oldest registered device.
- You can also enter pairing mode by pressing the OPTION button when the Bluetooth playback screen is displayed and selecting "Pairing Mode" from the displayed option menu.

NOTE

- To operate the Bluetooth device with the remote control of this unit, the Bluetooth device needs to support the AVRCP profile.
- The remote control of this unit is not guaranteed to work with all Bluetooth devices.
- For some Bluetooth devices, the volume set on the Bluetooth device is linked with that of the audio signal output from the PREAMP OUT connectors of this unit.



Reconnecting to this unit from a Bluetooth device

After pairing is completed, the Bluetooth device can be connected without performing any operations on this unit.

This operation also needs to be performed when switching the Bluetooth device for playback.

- 1 If a Bluetooth device is currently connected, deactivate the Bluetooth setting of that device to disconnect it.**
- 2 Activate the Bluetooth setting of the Bluetooth device to be connected.**
- 3 Select this unit from the Bluetooth device list on your Bluetooth device.**
- 4 Play music using any app on your Bluetooth device.**



- When the power of this unit and the Bluetooth function of this unit are turned on, the input source will be automatically switched to “Bluetooth” if a Bluetooth device is connected.
- When the “Network Control” setting of this unit is set to “On” and a Bluetooth device is connected and is played with the unit in the standby state, the power of the unit will be turned on automatically. (🔗 p. 107)



Listening to audio on Bluetooth headphones

You can listen to the sounds that are played back in this device from Bluetooth headphones.

Output audio from connected speakers and Bluetooth headphones simultaneously, or only using Bluetooth headphones.

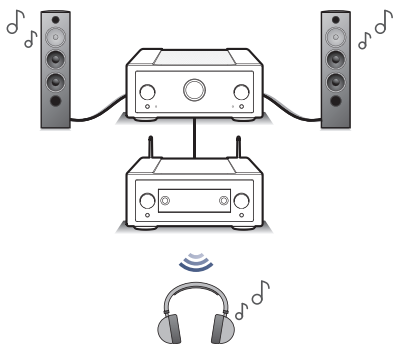

Output Mode: HP+ Speakers

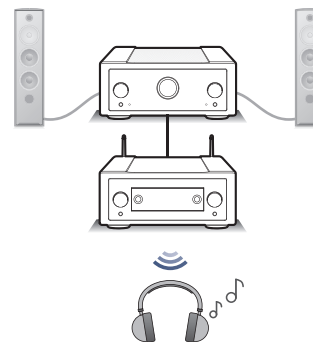

Output Mode: Headphones

NOTE

- If you want to output audio only from Bluetooth headphones while your amplifier with speakers is connected to this unit, connect the amplifier to the PREAMP OUT connectors on this unit.



Listening to audio on Bluetooth headphones

1 Set “Headphone” to “On” from the “Network” - “Bluetooth” setting in the setup menu. (🔧 p. 106)

2 Select “Output Mode”, and set audio output.

HP + Speakers (Default):

Audio is output to Bluetooth headphones, LINE OUT connectors, and PREAMP OUT connectors. Connect your amplifier with speakers to the LINE OUT or PREAMP OUT connectors of this unit.

This simultaneous output is suitable for family movie night and other group activities.

Headphones:

Audio is output to Bluetooth headphones.

This is suitable for listening to music or watching movies by yourself at night when you need to keep quiet.



- Audio is output from the LINE OUT connectors even when set to “Headphones”.

3 Enter pairing mode on the Bluetooth headphones you want to connect to this unit.

4 Select “Devices” and select the name of the Bluetooth headphones from the device list.

5 Adjust the volume of connected Bluetooth headphones after the connection is completed.





- A2DP profile-compatible Bluetooth speakers can be connected following the same steps used to connect Bluetooth headphones.

NOTE

- Bluetooth headphones volume cannot be adjusted from this unit. Adjust volume of your Bluetooth headphones.
- Audio may be delayed when sent over Bluetooth.
- AirPlay and Roon Ready audio cannot be transmitted.
- Bluetooth headphones cannot be connected when use a Bluetooth input source. Furthermore, selecting a Bluetooth input source will terminate the connection between this unit and Bluetooth headphones.
- Bluetooth headphones cannot be connected when this unit is grouped in the HEOS app.
- Bluetooth headphones cannot be connected if a HEOS Built-in device is playing an input source from this unit.

CAUTION:
Using Bluetooth headphones without a volume adjustment function

- In order to avoid hearing loss, do not connect Bluetooth headphones that lack volume adjustment functionality.
- Bluetooth headphone volume may be unexpectedly loud when this unit connects to Bluetooth headphones.
- Bluetooth headphone volume cannot be adjusted from this unit.

Reconnecting to a Bluetooth headphones

Follow any of the steps below to reconnect the most recently used Bluetooth headphones:

- Reconnect to this unit with Bluetooth headphone's reconnect function.
- If “Output Mode” is set to “HP + Speakers”, this unit will automatically connect to the most recently used Bluetooth headphones when power is turned on.
- Select the device you wish to connect from the “Devices” under “Bluetooth” in the setup menu. (👉 p. 106)

Disconnecting Bluetooth headphones

Complete any of the following steps to disconnect your Bluetooth headphones:

- Turn off your Bluetooth headphones.
- In the setup menu, go to “Network” - “Bluetooth”, and set “Headphone” to “Off”. (👉 p. 106)



Getting the HEOS app

You can use many online music streaming services from the HEOS app. Depending upon your geographical location, there are several options to choose from.

Download the HEOS app for iOS or Android by searching App Store, Google Play store or Amazon Appstore for “HEOS”.



- Specifications of the HEOS app may be changed without prior notice for improvement purposes.



Setting up the HEOS app for the first time with a HEOS Built-in device

Once you have placed this unit in your listening room and have downloaded the HEOS app, you are ready to configure this unit for music playback. This involves following a few simple steps to get this unit connected to your existing home network:



- DO NOT connect the Ethernet cable if you are connecting this unit to a wireless network. If you are connecting this unit to a wired network, use an Ethernet cable (not included) to connect this unit to your network or router.

1 Make sure your mobile device is connected to your wireless network (the network you want to connect to this device).

You can check this in the “Settings” - “Wi-Fi” menu of your iOS or Android device.



- Activate the Bluetooth setting on your mobile device.
- If your wireless network is secure, make sure you know the password to join your network.

2 Launch the HEOS app on your mobile device.



3 Tap the “Setup Now” button at the top of the screen.

4 Follow the instructions to add this unit to your wireless network and to select an input on this unit.



Adding the registration of HEOS Built-in devices in the HEOS app

The HEOS system is a true multiroom audio system that automatically synchronizes audio playback between multiple HEOS Built-in devices so that the audio coming from different rooms is perfectly in sync and always sounds amazing! You can easily add up to 32 HEOS Built-in devices to your HEOS system.

■ Adding wired HEOS Built-in devices

Just connect the HEOS Built-in devices to your home network using an Ethernet cable and the HEOS Built-in device will appear on your HEOS app as a new room in the Rooms screen. For information about wired LAN connections, refer to “Connecting to a home network (LAN)” (🔗 p. 35).

At your convenience, you can assign a name to the HEOS Built-in device to indicate which room you have it placed in.

■ Adding wireless HEOS Built-in devices

You can add additional wireless HEOS Built-in devices to your HEOS system by selecting “Add Device” from the HEOS app’s settings menu and follow the instructions:

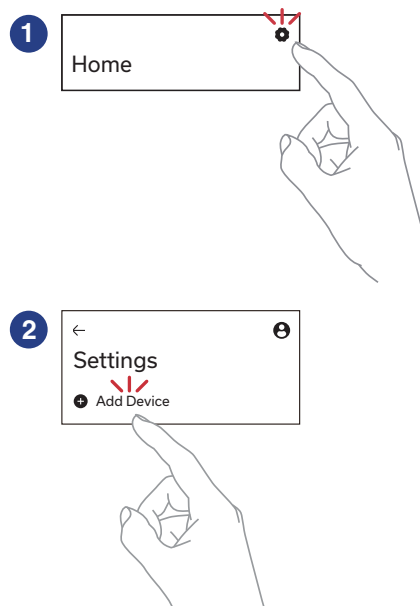

HEOS Account

HEOS Accounts can be registered by tapping “Home” tab - “Settings” icon  in the HEOS app.

Once you create or sign into your HEOS Account, you can use the HEOS Favorites feature to save and recall your favorite streaming radio stations using this unit.

■ What is a HEOS Account?

A HEOS Account is master account or “keychain” for managing all of your HEOS music services with one single username and password.

■ Why do I need a HEOS Account?

With the HEOS Account you just have to enter your music services login names and passwords one time. This allows you to easily and quickly use multiple controller apps on different devices.

You just log into your HEOS Account on any device and you will have access to all of your associated music services, play history and custom playlists, even if you are at a friend’s house listening to music on their HEOS system.



■ Signing up for a HEOS Account

You will be instructed to sign up for a HEOS Account the first time you try to access any music service from the main “Home” menu of the HEOS app. Follow the instructions in the HEOS app to complete the operation.



- This unit’s HEOS Account setting information is synced with the HEOS app. Change settings and sign out of your account through the HEOS app.

■ Changing your HEOS Account

- 1 Tap the “Home” tab.
- 2 Select the Settings icon  in the upper right corner of the screen.
- 3 Select the HEOS Account  icon in the upper right corner of the screen.
- 4 Change your location, change your password, delete your account or sign out of your account.



- This unit automatically syncs when you change your account settings or sign out through the HEOS app. To switch HEOS accounts, play back music from an HEOS app signed in to the account you wish to sync to this unit. The “HEOS Account” switches automatically.



Playing from streaming music services

A music service is an online music company that provides access to vast music collections via free and/or paid subscriptions. Depending upon your geographical location, there are several options to choose from.

NOTE

- The HEOS app and brand is not affiliated with any manufacturer of any mobile device. Availability of music services may vary by region. Not all services may be available at time of purchase. Some services may be added or discontinued from time to time based on decisions of the music service providers or others.

■ Selecting a room/device

- 1 Tap the “Rooms” tab. Select “Marantz LINK 10n” if there are multiple products with HEOS Built-in.



- Tap “Edit” at the top right to switch edit mode. You can change the displayed name.

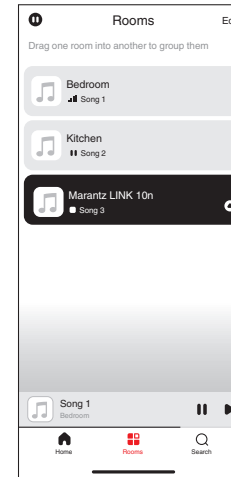

■ Selecting the music track or station from music sources

1 Tap the “Home” tab and select a music source.



- All music services displayed may not be available in your location.

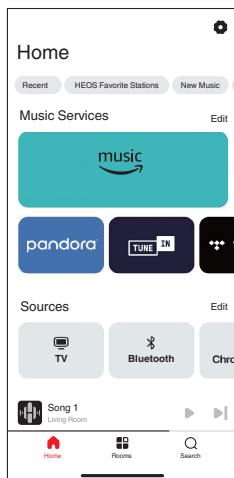

2 Browse the music to play.

After selecting a music track or radio station the app will automatically change to the “Now Playing” screen.



- Set “Network Control” of the setup menu to “On” so that when you are playing back from the HEOS app while this device is in standby, this device turns on automatically. (“Network Control” (p. 107))

Audio file

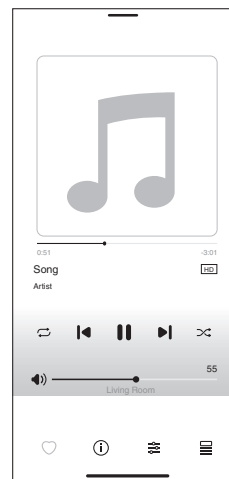

Streaming

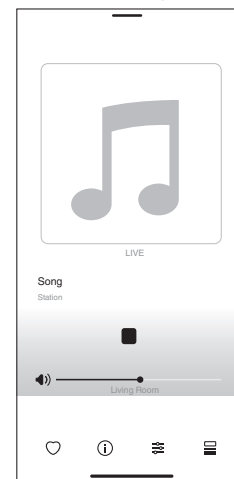

Listening to the same music in multiple rooms

This system is a true multi-room audio system. You can create one or more HEOS groups to automatically synchronize audio playback between multiple products with HEOS Built-in so that the music playing different rooms is perfectly in sync and always sounds amazing! You can easily add up to 32 products to your system in total. You can group up to 16 individual products to have them play the same song fully synchronized.

■ Grouping rooms

- 1** Press and hold your finger on room that is not playing music.
- 2** Drag it into the room that is playing music and lift your finger.
- 3** The two rooms will be grouped together into a single device group and both rooms will be playing the same music in perfect sync.

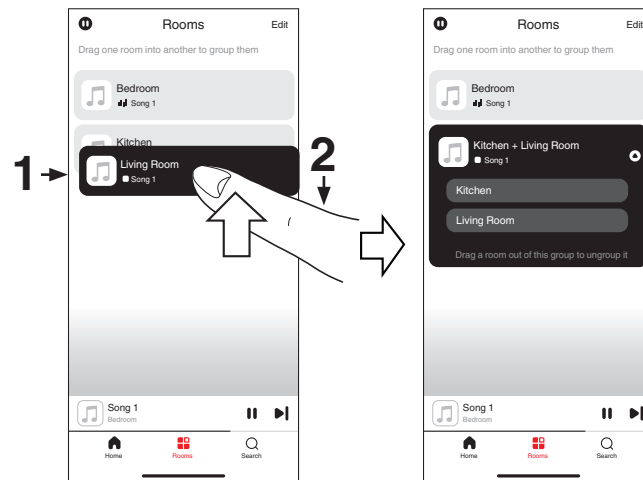

■ Ungrouping rooms

- 1 Press and hold your finger on room that you want to remove from the group.
- 2 Drag it out of the group and lift your finger.

NOTE

- You can not remove the first room that started playing the music before grouping.

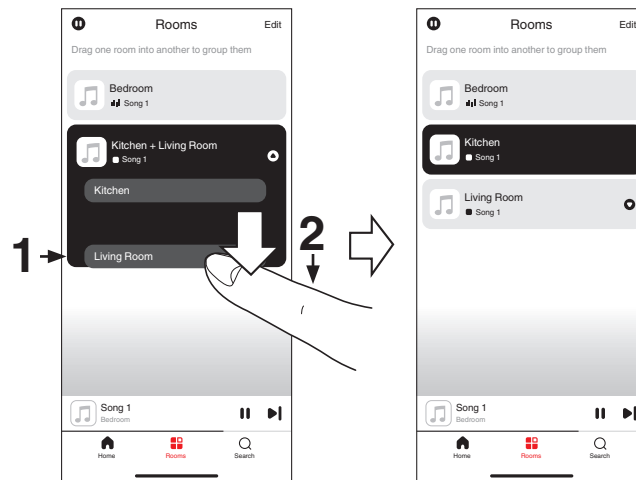

■ Grouping all rooms (party mode)

You can easily group 16 rooms together into Party Mode by using a “pinch” gesture.

- 1** Place two fingers on the screen over the list of rooms.
- 2** Quickly pinch your two fingers together and release.
- 3** All of your rooms will be joined together and begin playing the same music in perfect sync.

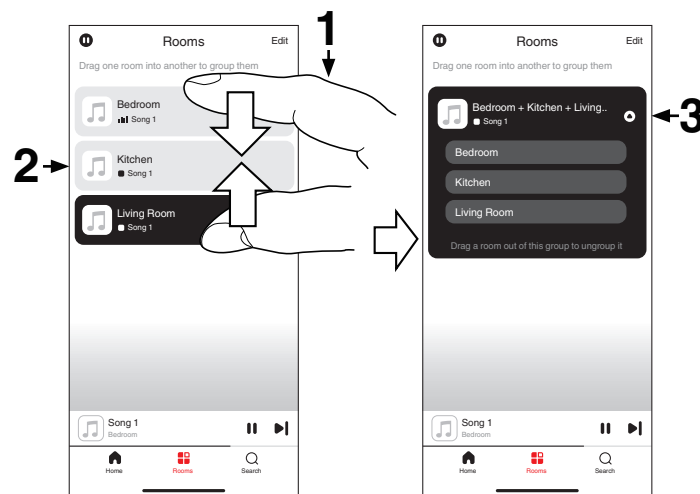

■ Ungrouping all rooms

You can easily ungroup all of your rooms and exit Party Mode by using a “spread” gesture.

- 1 Place two fingers close together on the screen over list of rooms.**
- 2 Quickly spread your two fingers apart from each other and release.**
- 3 All of your rooms will be ungrouped.**

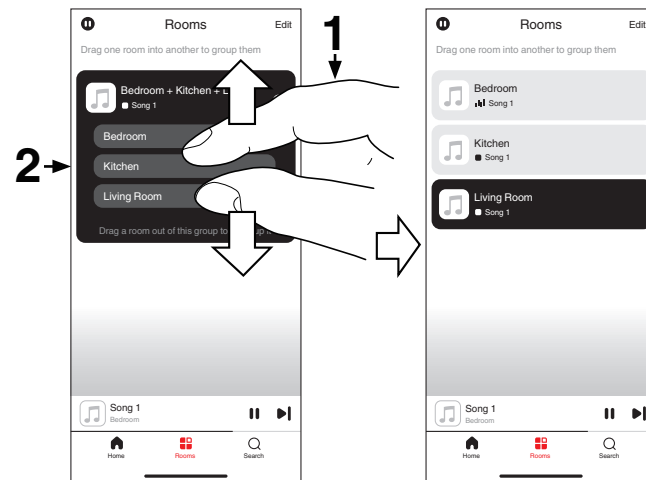



- When "TV Input" is set in the menu, this unit automatically turns on when the TV connected to the unit is turned on, and the input source switches to "HDMI", "Coaxial", "Optical 1" or "Optical 2". (👉 p. 101)
- If you connect your TV via the Optical or Coaxial connection, this unit cannot be put to standby when you turn off your TV. If you want to automatically put this device on standby, set "Auto-Standby" in the setup menu. (👉 p. 104)

NOTE

- Do not input non-PCM signals, such as Dolby Digital, DTS and AAC. This causes noise and could damage the speakers.
- Only the PCM 2-channel setting can be used to play sound from a TV via the ARC function. Set "PCM 2ch" as the audio format in the TV settings.

■ Display format and sample rate

During playback, press INFO.

- Each time the button is pressed, switches the display on and off.

■ Specifications of supported audio formats

See "Digital input" (👉 p. 136).

■ HDMI control function

Connect this unit to a TV that supports the HDMI control function with an HDMI cable and enable the HDMI control setting on the TV to perform basic operations on this unit (changing the input source, turning the power on and off, adjusting the volume) with the remote control of the TV.

Refer to "About HDMI" (👉 p. 141) for more information about the HDMI control function.



Connecting and playing back from a computer (USB-DAC)

You can enjoy high-quality audio playback from the D/A converter built in to this unit by inputting music files into this unit from a computer via USB connection.

- Before USB connecting this unit to your computer, install the driver software in your computer.
- Drivers do not need to be installed for macOS.
- Also, you can use whichever commercially available or downloadable player software you like to playback files on your computer.

■ Computer (system requirements)

OS

- Windows 10 or Windows 11
- macOS 13 or 14

USB

- USB 2.0: USB High speed/USB Audio Class Ver. 2.0

NOTE

- This unit was checked the operation using the system requirements by us, but it does not guarantee the operation of all systems.

- DSD is a registered trademark.
- Microsoft, Windows 10 and Windows 11 are either registered trademarks or trademarks of Microsoft Corporation in the United States and/or other countries.
- ASIO is a trademark and software of Steinberg Media Technologies GmbH.
- Apple, Macintosh and macOS are trademarks of Apple Inc., registered in the U.S. and other countries.

Windows OS Installing the dedicated driver (👉 p. 73)

macOS Audio Device Settings (👉 p. 79)



■ Installing the dedicated driver (Windows OS only)

□ Installing the driver software

- 1 Disconnect the USB cable between your PC and the unit.**
 - The driver software cannot be installed correctly if your PC is connected to the unit by a USB cable.
 - If the unit and your computer are connected by a USB cable and the computer is switched on before installation, disconnect the USB and restart the computer.
- 2 Download the dedicated driver from the “Download” section of the LINK 10n page of the Marantz website onto your PC.**
- 3 Unzip the downloaded file, and double-click the exe file.**

4 Install the driver.

- ① Select the language to use for the installation.
- ② Click “OK”.

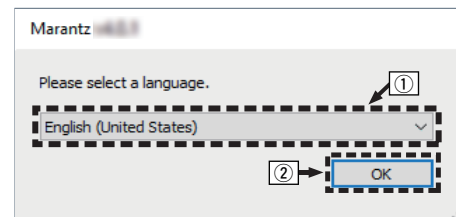

- ③ The wizard menu is displayed. Click “Next”.



- ④ Read the Software Licensing Agreement, and click “I accept the terms in the License Agreement.”
⑤ Click “Next”.

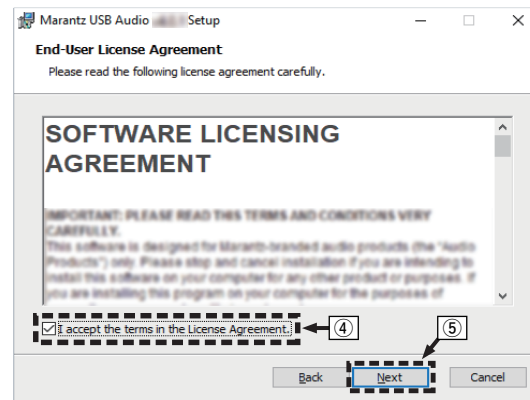

- ⑥ Select the installation destination and click “Next”.

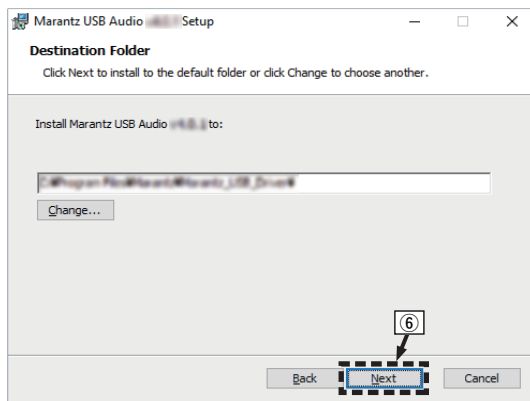

- ⑦ Click “Install” on the installation start dialog.

- The installation starts. Do not perform any operation on the PC until the installation is completed.

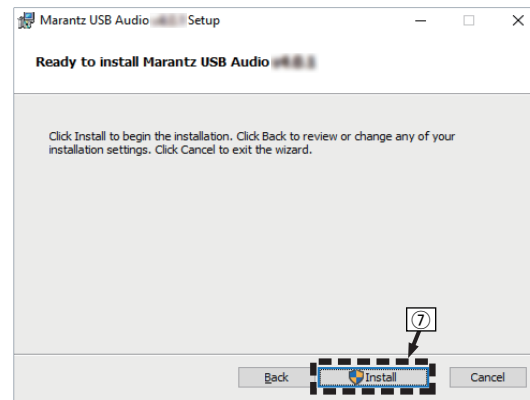

- ⑧ When the installation is completed, click “Finish”.

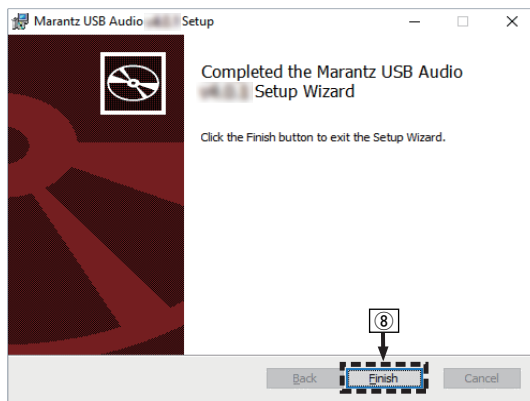

5 With the unit power off, connect the unit and PC using a USB cable (not included).

- For details on connections, see “Connecting a PC or Mac” (🔗 p. 33).

6 Press **⏻**.

- When the unit power is turned on, the PC automatically finds and connects to the unit.

7 Press **USB-DAC** to switch the input source to “USB-DAC”.

8 Checking the installed driver.

- ① Open the “Control Panel” on the PC.
 - The control panel setting list is displayed.
- ② Click “Sound”.
 - The sound menu window is displayed.
- ③ Check that there is a checkmark next to “Default Device” under in “LINK 10n” of the “Playback” tab.
 - When there is a checkmark for a different device, click “LINK 10n” and “Set Default”.



9 Checking audio output.

Outputs a TEST signal from the PC and checks the audio output from the USB-DAC function.

- ① Select “LINK 10n” and click “Properties”.
 - The Properties window is displayed.

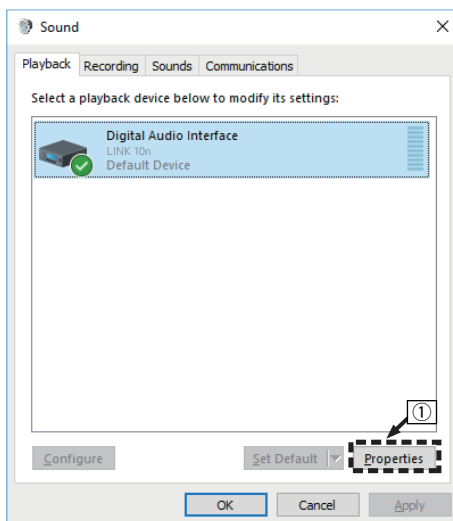

- ② Click the “Advanced” tab.
- ③ Select the sampling rate and bit rate to be applied to the D/A converter.
 - It is recommended that “2 channel, 32 bit, 192000 Hz (Studio Quality)” is selected.
- ④ Click “Apply”.
- ⑤ Click “Test”.
 - Check that audio from this unit is output from the PC.

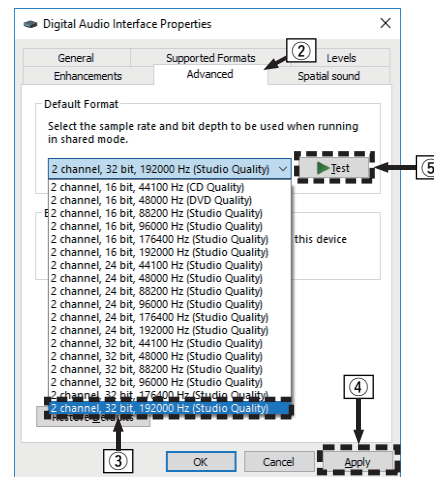



- The dedicated driver must be installed in the PC before this unit is connected to a PC. Operation will not occur correctly if connected to the PC before the dedicated driver has been installed.
- Operation may fail in some PC hardware and software configurations.
- Player software supporting the Audio Stream Input Output (ASIO) driver is required to play files with a sampling frequency of 352.8 kHz/384 kHz without downsampling. Check your player software before playing files with the ASIO driver.
- Please see the FAQ at www.marantz.com if you experience any issues getting audio to play from your computer through this unit. You may also want to check the support pages for your audio player application.



■ Audio Device Settings (macOS only)

- ① With the unit power off, connect the unit and Mac using a USB cable (not included).
 - For the connection procedure, refer to the “Connecting a PC or Mac” section. (👉 p. 33)
- ② Press ϕ .
- ③ Press USB-DAC to switch the input source to “USB-DAC”.
- ④ Move the cursor to “Go” on the computer screen, and then click “Utilities”.
 - The utility list is displayed.
- ⑤ Double-click “Audio MIDI Setup”.
 - The “Audio Devices” window is displayed.
- ⑥ Secondary click on “LINK 10n”, and then check that “Use This Device For Sound Output” is checked.
 - If a different device is checked, select and secondary click on “LINK 10n”, and then select “Use This Device For Sound Output”.

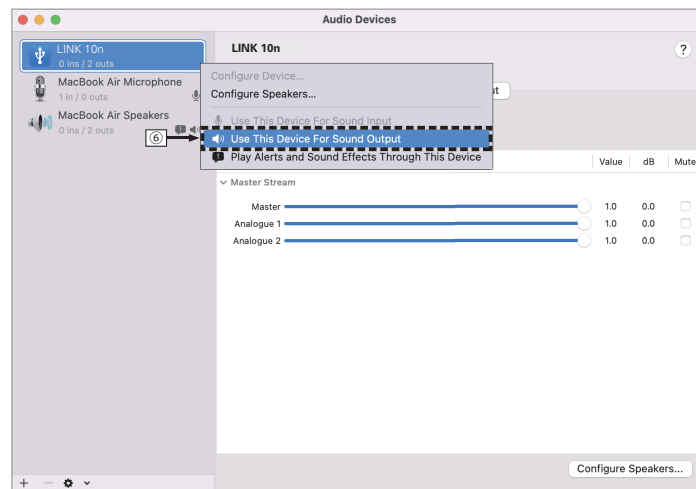

- ⑦ Select the “LINK 10n” format.
- It is normally recommended to set the format to “2 ch 32-bit Integer 384.0 kHz”.

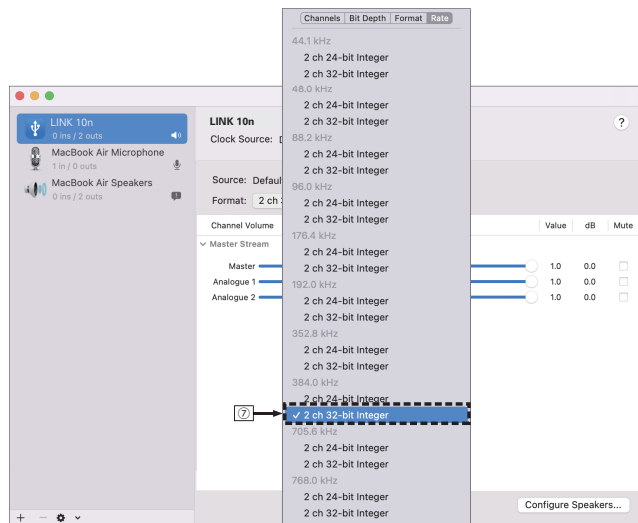

- ⑧ Quit Audio MIDI Setup.

■ Playback

Install the desired player software on your computer beforehand.
Use the rear panel USB-DAC port to connect this unit to a computer.
(☞ p. 33)

1 Press USB-DAC to switch the input source to “USB-DAC”.

Start playback on the computer’s player software.

- If the sampling frequency cannot be detected, “Signal Unlock” will be displayed.
- “Unsupported Format” is displayed when audio signals that are not supported by this unit are input.

■ Display format and sample rate

During playback, press INFO.

- Each time the button is pressed, switches the display on and off.

■ Specifications of supported audio formats

See “Digital input” (☞ p. 136).





- Perform operations such as playback and pause on the computer. At this time, you cannot perform operations with buttons on this unit or the remote control.
- When this unit is functioning as a D/A converter, sound is not output from the computer's speakers.
- If the computer is disconnected from this unit while the computer music playback software is running, the playback software may freeze. Always exit the playback software before disconnecting the computer.
- When an error occurs on the computer, disconnect the USB cable and restart the computer.
- The sampling frequency of the music playback software and sampling frequency displayed on this unit may differ.
- Use a cable that is 10 ft (3 m) or less to connect to the computer.



Playing analog input

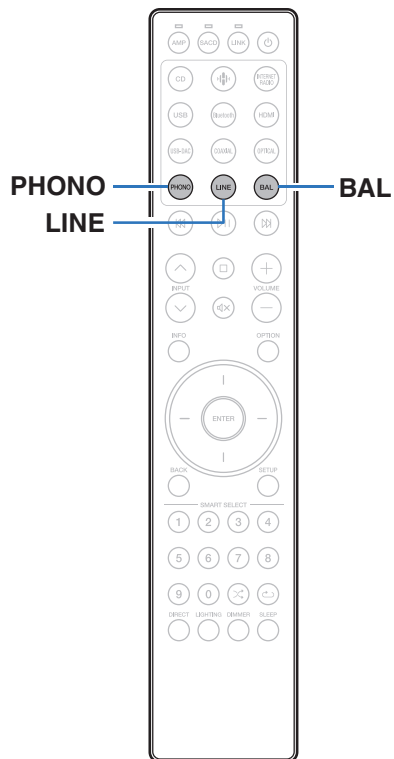

1 Prepare for playback.

Check the connection, then turn on this units. (“Connecting a playback device” (p. 25))

2 Press LINE, BAL or PHONO to switch the input source to “Line”, “Balanced” or “Phono”.

3 Play the component connected to this unit.



AirPlay function

Music files stored on your iPhone, iPod touch, iPad, Mac or Windows PC can be played on this unit via the network.



- Input source will be switched to “AirPlay” when AirPlay playback is started.
- You can stop AirPlay playback by choosing other input source.
- The screen may differ depending on the OS and software versions.

This device supports AirPlay 2.

Sync multiple AirPlay 2 compatible devices/speakers for simultaneous playback.

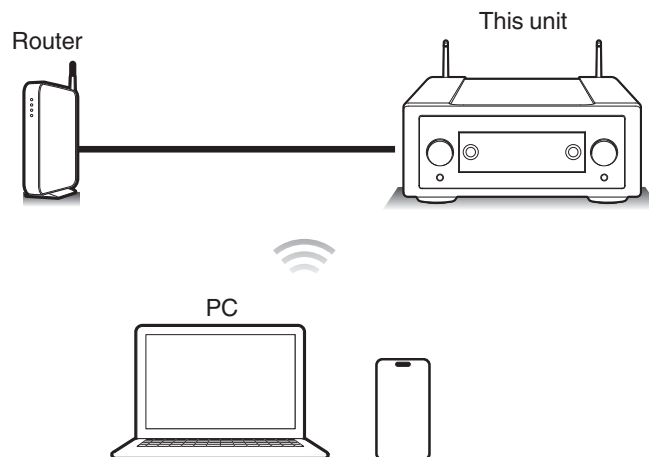

Playing songs from your iPhone, iPod touch, iPad or Mac

You can stream music stored in your “iPhone/iPod touch/iPad/Mac” directly to this unit.

1 Connect your iPhone, iPod touch, iPad or Mac Wi-Fi to the same network as this unit.

- For details, see your device’s manual.

2 Open Apple Music and play music from your iPhone, iPod touch or iPad.

3 Tap or click the AirPlay icon and select this unit.

[Example] iOS 15 or macOS 13

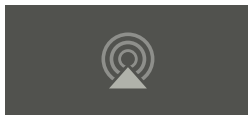

[Example] iOS 10



- You can also use AirPlay to stream music from other applications. Open the Control Center, tap or click the AirPlay icon, then select this unit.
- To use AirPlay, your iOS device must support iOS 10.0.2 or later, or OS X Mountain Lion 10.8 or later.

Playing songs from Windows PC

- 1 Install iTunes 10, or later, on a Windows PC that is connected to the same network as this unit.
- 2 Start iTunes and click the AirPlay icon to select this unit.

[Example] iTunes



3 Choose a song and click play in iTunes.

The music will stream to this unit.



- When “Network Control” is set to “On”, you can turn on this unit by operating iTunes. (🔧 p. 107)
- For information about how to use iTunes, also see the Help for iTunes.



Play a song from your iPhone, iPod touch, iPad or Mac on multiple synced devices (AirPlay 2)

Songs from an iPhone, iPod touch, iPad or Mac can be synced with multiple AirPlay 2 supported devices for simultaneous playback.

1 Play the song on your iPhone, iPod touch, iPad or Mac.

AirPlay icon is displayed on the iPhone, iPod touch, iPad or Mac screen.

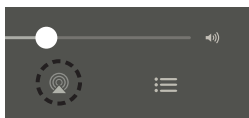

2 Tap or click the AirPlay icon and select this unit.

Displays a list of devices/speakers that can be played back on the same network.

- A circle is displayed to the right of AirPlay 2 compatible devices.

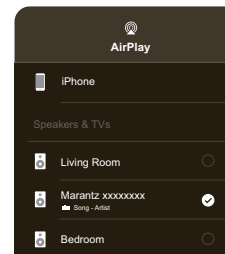

3 Select the devices/speakers you want to use.

- Multiple AirPlay 2 compatible devices can be selected.

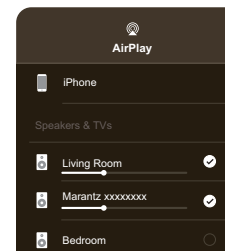

- To use AirPlay 2, your iOS device must support iOS 11.4 or later, or macOS Catalina or later.



Spotify Connect function

Spotify is all the music you'll ever need. Millions of songs available instantly. Just search for the music you love, or let Spotify play you something great. Spotify works on your phone, tablet, computer and home speakers. So you'll always have the perfect soundtrack for whatever you're doing. Now you can enjoy Spotify with your free account as well as Premium account.

Use your phone, tablet or computer as a remote control for Spotify.

Go to www.spotify.com/connect to learn how.

The Spotify software is subject to third party licenses found here:

www.spotify.com/connect/third-party-licenses

Playing Spotify music with this unit

Download the "Spotify App" onto your iOS or Android device beforehand.

- 1 Connect the Wi-Fi settings of the iOS or Android device in the same network as this unit.**
- 2 Launch the Spotify App.**
- 3 Play back the Spotify track.**
- 4 Tap the Spotify icon  to select the unit.**

The music will stream to this unit.

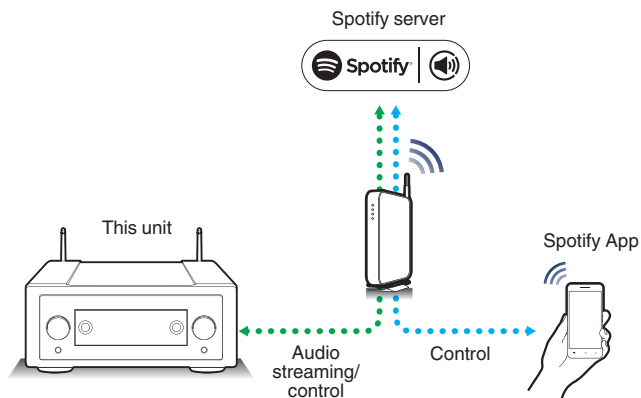

Convenience functions

- This section explains how to use convenient functions that can be used for each input source.
- Control of “HEOS Favorites” operations is optimized for the app. For more information on acquiring the app, see “Getting the HEOS app” (📖 p. 60).

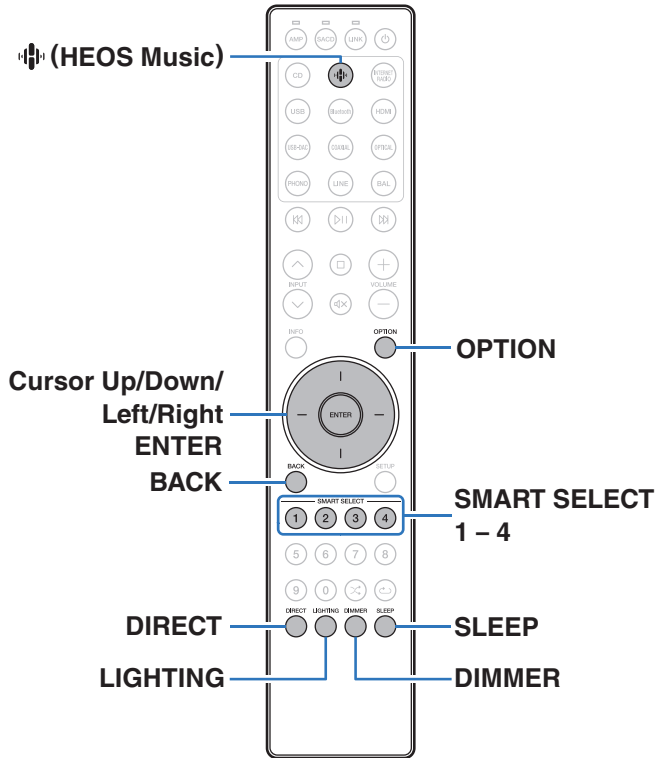

Playing back HEOS Favorites

When using the HEOS Favorites function for the first time on this unit, create a HEOS Account on the HEOS app or sign in to your account. Once you create or sign into your HEOS Account, you can use the HEOS Favorites feature to save and recall your favorite streaming radio stations using this unit.

1 Press (HEOS Music).

If a playback history is present, the last Internet radio station or song played is played back. Pressing  (HEOS Music) again displays the HEOS Music top menu.

2 Use Cursor Up/Down buttons to select “Favorites”, then press ENTER.

3 Use Cursor Up/Down buttons to select the content you would like to playback, then press ENTER.

4 Use Cursor Up/Down buttons to select “Play Now”, then press ENTER.



- You can no longer select “Favorites” from the HEOS Music top menu when this unit is not synced with a HEOS Account in the HEOS app.
- You can also display the “HEOS Favorites” list by pressing the Favorites button () on the main unit.

Adding to HEOS Favorites

This function only works for streamed content.

1 While content is playing, press OPTION.



The option menu screen is displayed.

2 Use Cursor Up/Down buttons to select “Add to HEOS Favorites”, then press ENTER.

3 Use Cursor Up/Down buttons to select the “HEOS Favorites” number you would like to save your contents to, then press ENTER.



Deleting a HEOS Favorites

- 1 Press  (HEOS Music).**
If a playback history is present, the last Internet radio station or song played is played back. Pressing  (HEOS Music) again displays the HEOS Music top menu.
- 2 Use Cursor Up/Down buttons to select “Favorites”, then press ENTER.**
- 3 While the HEOS Favorites content list is displayed, use Cursor Up/Down buttons to select the item you want to remove from HEOS Favorites, then press ENTER.**
- 4 Use Cursor Up/Down buttons to select “Remove from HEOS Favorites”, then press ENTER.**

Adjusting the tone and balance

Adjusts the tone and balance of the audio signal output from the PREAMP OUT connectors and the headphones jack.

■ Adjusting the tone

- 1 Press OPTION.**
The option menu screen is displayed.
- 2 Use Cursor Up/Down buttons to select “Tone”, then press ENTER.**
- 3 Use Cursor Up/Down buttons to select “Bass” or “Treble”.**
- 4 Use Cursor Left/Right buttons to adjust the bass or treble volume.**



- When the source direct mode is turned on, the tone adjustment function does not work.



■ Adjusting the volume balance

- 1 Press OPTION.**
The option menu screen is displayed on the display.
- 2 Use Cursor Up/Down buttons to select “Balance”, then press ENTER.**
- 3 Use Cursor Left/Right buttons to adjust the volume balance.**



- When the source direct mode is turned on, the volume balance adjustment function does not work.

Playback in source direct mode

The signal does not pass through the tone adjustment circuitry, resulting in playback of a higher sound quality.

Source direct mode works only with audio signals output from the PREAMP OUT connectors and the headphones jack.

- 1 Press DIRECT to turn on source direct mode.**
“Source Direct” is displayed on the display.



Switching the display's brightness

The display brightness can be adjusted from 100 % to Off (0 %) in steps of 5 %. Switching the display off reduces a source of noise that affects sound quality, enabling higher sound quality playback.

1 Press DIMMER.

The dimmer menu screen is displayed on the display.

2 Use Cursor Up/Down buttons to adjust the brightness of the display.

- You can also adjust the brightness by pressing DIMMER.



- If button operations are made while the display is off, information is temporarily displayed at 100 %.
- The display brightness is set to 100 % by default.
- The display brightness setting is synchronized with the "Illumination" - "Display" setting in the settings menu. (☞ p. 103)
- DIMMER does not work when LIGHTING is pressed and turned off.

Turning the illumination and display on/off

Turn on/off the illumination and display. Switching the illumination and display off reduces a source of noise that affects sound quality, enabling higher sound quality playback.

1 Press LIGHTING.

- Each time the button is pressed, the illumination and display are turned on/off.



- In the Settings menu, "Illumination" allows you to set the brightness of the illumination and display. (☞ p. 103)
- When LIGHTING is pressed and lit, the illumination and display light up to the brightness set in "Illumination" in the Settings menu. (☞ p. 103)



Using the sleep timer

You can have the power automatically switched to standby once a set time has elapsed. This is convenient for listening while going to sleep.

1 Press SLEEP during playback and select the setting time.

- The sleep timer can be set to up to 90 minutes, in steps of 10 minutes.
- After about 5 seconds, the setting is entered and the display returns to as it was before.
- The sleep icon and the remaining time appears on the display.

■ To cancel the sleep timer

1 Press SLEEP to set “Off”.

The sleep icon on the display turns off.



- The sleep timer setting is canceled when the unit switches to standby mode.
- To check the time remaining until the sleep timer is activated, press SLEEP.

Displaying the volume at all times (When “Preamp Out” is set to “On”)

The volume can always be displayed when this unit is used as a preamplifier with “Preamp Out” set to “On” in the setup menu. (✎ p. 98)

1 Press BACK during playback.

The display switches to the volume display screen.



- When the input source is HEOS or Bluetooth, the display does not switch to the volume display screen.
- Press BACK when volume is displayed to return to the previous screen.



Smart select function

Settings such as the input source, volume level, source direct settings and tone settings in the option menu can be registered to the SMART SELECT 1 - 4 buttons.

You can simply press one of the registered SMART SELECT buttons in subsequent playbacks to switch to the group of saved settings in a batch. By saving frequently used settings at the SMART SELECT 1 - 4 buttons, you will always be able to easily call up the same playback environment.

■ Calling up the settings

1 Press SMART SELECT.

The smart select settings registered to the button you pressed are called up.

- The default settings for the input source are as shown below.

Button	Input source
SMART SELECT 1	HEOS
SMART SELECT 2	Balanced
SMART SELECT 3	Phono
SMART SELECT 4	HDMI



- Volume is not registered to smart select in the factory default settings. See "Changing the settings" to register volume to smart select. (👉 p. 93)

■ Changing the settings

1 Set the items below to the settings you want to register.

- ① Input source (👉 p. 43)
- ② Volume (👉 p. 43)
- ③ Source direct (👉 p. 90)
- ④ Tone in the option menu (👉 p. 89)



- Press and hold SMART SELECT while a radio station is being received is being played back with any of the following sources, the current radio station is memorized.
 - Internet Radio Station / Spotify

2 Press and hold the desired SMART SELECT for more than 3 seconds.

"Saved" appears on the display and the current settings will be memorized.



Menu map

For menu operations, see the following page.

By default, this unit has recommended settings defined. You can customize this unit based on your existing system and your preferences.

Setting items	Detailed items	Description	Page
Audio	Filter	This unit is equipped with a sound quality adjusting function which allows users to enjoy the desired playback sound quality.	97
	Dither	This function adds audio data to minimize quantization error. Audio data to be added can be set on this unit. The sound quality changes. Set as desired.	97
	Noise Shaper	Improves linearity and noise characteristics in the audible range using digital feedback. The measurements are the same but the sound quality changes. Set as desired.	98
	Preamp Out	Switches on/off the audio signal output from the PREAMP OUT connectors.	98
	Volume Scale	Set how the volume is displayed.	99
	Volume Limit	Make a setting for maximum volume. The volume cannot be increased above this setting.	99
	Digital Out	Stopping digital audio output reduces a source of noise that affects sound quality, enabling higher sound quality playback.	99
	HP Amplifier Gain	Set the gain of the headphone amplifier. By setting according to the impedance of your headphone, you can enjoy playing headphones at an appropriate volume.	99
	Phono	Sets the phono equalizer of this unit according to the type or impedance of the turntable cartridge to be connected.	100
	Low Pass Filter	Sets the low pass filter for the subwoofer output. Set this according to your speakers and subwoofer.	100



Setting items	Detailed items	Description	Page
TV	TV Input	Set this when playing audio from a TV on this unit.	101
	HDMI Power Off Control	Set the "HDMI Power Off Control" function that is keyed to the power off operation of your TV to turn the device's power to standby.	102
General	Illumination	You can adjust the brightness of the illumination and display. You can also link the illumination to the brightness of the display. When the brightness is turned "Off", the noise source affecting the sound quality is suppressed, and high-quality sound playback is possible.	103
	Language	Sets the language for display the menu.	103
	Auto-Standby	Sets the unit power to standby when the unit is not in use.	104
	Reset	Various settings are reset to the factory default values.	104
Network	Network Information	Displays various information about the network.	105
	Wi-Fi	The Wi-Fi function can be stopped to prevent noise that affects the sound quality.	105
	Bluetooth	Stopping Bluetooth function reduces a source of noise that affects sound quality, enabling higher sound quality playback. It also sets the Bluetooth transmitter settings.	106
	Network Control	Performs the on/off settings for the network function when in standby mode.	107
	AirPlay Setup	Set this unit to WAC mode. Perform this setup when connecting to a network using an iOS device.	108



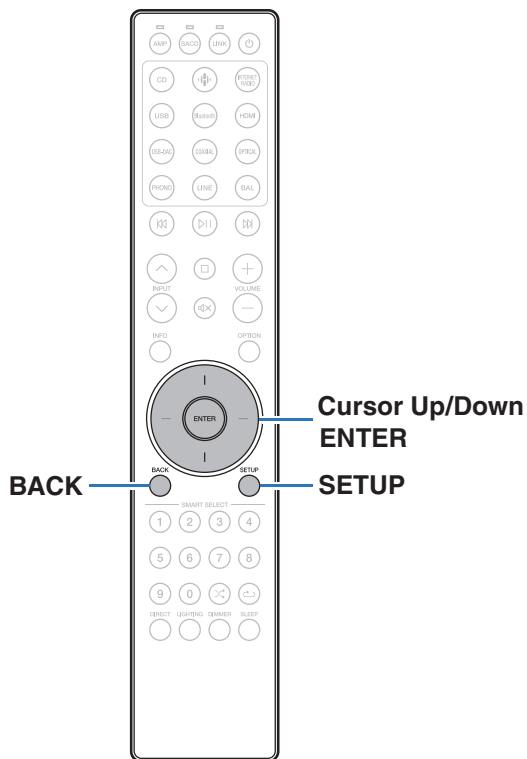

Menu operation

1 Press **SETUP**.

The setup menu is displayed on the display.

2 Use **Cursor Up/Down** buttons to select the setup menu to be set or operated, then press **ENTER**.

3 Use **Cursor Up/Down** buttons to change to desired setting.



- Step 3 may not be necessary for some menu items. In this case, the settings will be switched on and off each time you press ENTER.

4 Press **ENTER** to enter the setting.

- To return to the previous item, press **BACK**.
- Exiting the setup menu, press **SETUP** while the setup menu is displayed. The display returns to the normal display.



Audio

Make audio-related settings.

Filter

This unit is equipped with a sound quality adjusting function which allows users to enjoy the desired playback sound quality. The unit supports PCM signal.

Filter 1 (Default):

Offers a short impulse response for both pre-echo and post-echo. Large amount of audio information clearly reproduces deep stereo imaging and the relative position of the sound source.

Filter 2:

This characteristic is known as asymmetrical impulse response. The post echo is slightly longer than the pre-echo. The sound characteristics is more analog like.

Dither

Dither is used to avoid artifacts of digital signal processing. Side effect of dither is that Signal/Noise ratio is slightly reduced or artifacts do not completely disappear. Set as desired.

Dither 1 (Default):

This is a Marantz developed dither that reduces digital artifacts while reducing SNR only very little.

Dither 2:

Classic dither that reduces all artifacts but also reduces SNR.

Off:

Highest SNR but digital artifacts may slightly influence soundstage or colorate the sound.

NOTE

- The Dither function does not work when playing a DSD audio source.



Noise Shaper

Improves linearity and noise characteristics in the audible range using digital feedback. The following degrees and methods can be set. The measurements are the same but the sound quality changes. Set as desired.

Balanced (Default):	This is the best compromise between highest signal to noise ratio and most open and detailed sound stage.
Natural:	This gives high SNR for natural instruments but may reduce some resolution.
Dynamic Music:	This improves the SNR but this cost resolution in sound stage. Highest possible dynamics for wideband music content in this setting.
Dynamic Voice:	Even higher SNR but only up to 5 kHz. This gives highest possible dynamics for natural instruments and voices.

NOTE

- The Noise Shaper function does not work when playing a DSD audio source.

Preamp Out

Switches on/off the audio signal output from the PREAMP OUT connectors.

On (Default):	Enables audio signal output from the PREAMP OUT connectors. Control the volume of the audio signal output from this unit's PREAMP OUT terminals with the HEOS app or TV remote control unit (HDMI control function).
Off:	Disables audio signal output from the PREAMP OUT connectors. Control the volume of the Marantz amplifier connected to this unit with the HEOS app or TV remote control unit (HDMI control function).



- It may not be possible to control the volume with the TV remote control (HDMI control function) depending on the Marantz amplifier and TV connected to this unit.



Volume Scale

Set how the volume is displayed.

0 - 100 (Absolute) (Default):	Display volume in absolute value.
-99.5 dB - 0 dB (Relative):	Display volume in relative value.

Volume Limit

Make a setting for maximum volume. The volume cannot be increased above this setting.

Off (Default):	Do not set a maximum volume. (100 (0 dB))
95.0 (-5.0 dB) / 90.0 (-10.0 dB) / 85.0 (-15.0 dB) / 80.0 (-20.0 dB)	

Digital Out

Stopping digital audio output reduces a source of noise that affects sound quality, enabling higher sound quality playback.

On (Default):	Digital audio output is enabled.
Off:	Digital audio output is disabled.

HP Amplifier Gain

Set the gain of the headphone amplifier. Set this according to the impedance of the connected headphones. It is recommended that this is set on the “Low” side if the headphones have low impedance and on the “High” side if they have high impedance.

High:	Set the gain of the headphone amplifier to “High”. Set this if the volume is too low at the factory default setting.
Mid (Default):	Set the gain of the headphone amplifier to “Mid”.
Low:	Set the gain of the headphone amplifier to “Low”. Set this if the volume is too high at the factory default setting.

NOTE

- The headphone volume varies depending on the HP Amplifier Gain setting. Decrease the volume or mute the audio first if changing this setting while listening to audio.



Phono

Sets the phono equalizer of this unit according to the type or impedance of the turntable cartridge to be connected.

MM (Default):	Set this for an MM cartridge.
MC - Low:	Use this setting for an MC cartridge of less than 50 Ω /ohms.
MC - Mid:	Use this setting for an MC cartridge of about 50 Ω /ohms.
MC - High:	Use this setting for an MC cartridge of 100 Ω /ohms or higher.



- For an MC cartridge, select the input impedance closest to the impedance recommended for the cartridge used or select a value a few times that of the cartridge's internal impedance.
- If this setting change operation is performed, playback sound is output approximately 4 seconds after the change.

Low Pass Filter

Sets the low pass filter for the subwoofer output. Set this according to your speakers and subwoofer. The output audio signal has a lower frequency than the set value.

40 Hz / 60 Hz / 80 Hz / 100 Hz / 120 Hz (Default: 80 Hz)



TV

TV Input

Set this when playing audio from a TV on this unit. When the TV is turned on, this unit turns on and the input source is automatically switched to "HDMI", "Optical 1", "Optical 2" or "Coaxial" so that the audio from the TV can be played through this unit.

■ Default Input

Set the input source to be used when playing audio from the TV through this unit. Set this according to the jack on this unit being used to connect to the TV (HDMI (ARC), OPTICAL 1/2 input or COAXIAL input).

None / HDMI (ARC) / Optical 1 / Optical 2 / Coaxial In
(Default: HDMI (ARC))

■ Auto-Play

When a TV audio source is input to this unit, the unit automatically switches to the input source set in "Default Input" and the Auto-Play function for playing TV audio on this unit is set.

On
(Default): Enables the Auto-Play function.

Off: Disables the Auto-Play function.



- The Auto-Play function does not work when "Default Input" is set to "None". Set "Default Input" in advance.
- The Auto-Play function will not work if the sampling frequency of the audio signal input from this unit's OPTICAL 1/2 input terminal and COAXIAL input terminal is 88.2 kHz or more. TVs normally output 48 kHz audio signals and the Auto-Play function will work, but if you connect a device that outputs an audio signal of 88.2 kHz or more and try to use it, the Auto-Play function may not work.



HDMI Power Off Control

Set the “HDMI Power Off Control” function that is keyed to the power off operation of your HDMI connected TV to turn the device's power to standby.

All (Default) :	Regardless of the input source of this device, if the power of the TV is turned off, the power of this device automatically becomes standby.
HDMI (ARC):	If the input source is HDMI and you power off the TV, the power of this device automatically becomes standby.
Off:	This unit is not linked to the power of the TV.



General

Illumination

You can adjust the brightness of the illumination and display. You can also link the illumination to the brightness of the display. When the brightness is turned "Off", the noise source affecting the sound quality is suppressed, and high-quality sound playback is possible.

■ Display

100 – 5 (Default: 100)

Off:



- The display brightness setting is synchronized with the Dimmer menu setting. (👉 p. 91)

■ Front Panel

Sync (Default): The brightness of the illumination is linked to the brightness of the display.

100 – 5

Off:

Language

Sets the language for display the menu.

English / Français / Español (Default : English)



Auto-Standby

Sets the amount of time that must elapse without unit operation or an input signal before the unit goes into standby automatically.

Off (Default):	The unit does not go into standby automatically.
1 min:	The unit goes into standby after 1 minutes.
5 min:	The unit goes into standby after 5 minutes.
15 min:	The unit goes into standby after 15 minutes.
Custom:	Sets the minutes (between 1 and 99) before the unit automatically goes into standby. After setting the amount of time with the cursor Up/Down buttons, press ENTER to confirm the setting.

Reset

Perform this procedure if the display is abnormal or if operations cannot be performed. Restores the contents of each setting to the factory settings. Make settings again.

Yes:	Unit is initialized.
No (Default):	Unit is not initialized.



Network

Network Information

Displays network information.

**Name / Connection / SSID / DHCP / IP Address / MAC Address
(Ethernet) / MAC Address (Wi-Fi)**

Wi-Fi

The Wi-Fi function can be stopped to prevent noise that affects the sound quality. Using a wired LAN to connect this unit to the network enables playback with a high sound quality.

On
(Default): Enables the Wi-Fi function.

Off: Disables the Wi-Fi function.



Bluetooth

Bluetooth

Stopping Bluetooth receiver and transmitter functions reduces a source of noise that affects sound quality, enabling higher sound quality playback.

On (Default):	Enables the Bluetooth function.
Off:	Disables the Bluetooth function.

Headphone

Enables or disables the Bluetooth headphones transmitter. Perform these settings when you are listening to audio playback of this unit with Bluetooth headphones.

On:	Enables the Bluetooth headphones transmitter feature.
Off (Default):	Disables the Bluetooth headphones transmitter feature.

Output Mode

Selects the audio output method.

HP + Speakers (Default):	Audio is output to Bluetooth headphones, LINE OUT connectors, and PREAMP OUT connectors. Connect your amplifier with speakers to the LINE OUT or PREAMP OUT connectors of this unit.
Headphones:	Audio is output to Bluetooth headphones.



- Audio is output from the LINE OUT connectors even when set to “Headphones”.

Devices

- Available devices are displayed in the list once you start pairing mode on the Bluetooth headphones you want to connect. Select your Bluetooth headphones from the list to pair them.
- This unit can only pair with one Bluetooth headphone at a time. However, up to 8 Bluetooth headphones can be registered. Switch between registered devices from “Devices” in the “Bluetooth” setup menu.
- To remove a saved Bluetooth device from the list, use the cursor Up/Down buttons to select it, then press the OPTION button and select “Forget Device”.





- A2DP profile-compatible Bluetooth speakers can be connected following the same steps used to connect Bluetooth headphones.

NOTE

- Bluetooth transmitter and Bluetooth receiver function cannot be used at the same time. Bluetooth transmitter function is not available when listening to music on a Bluetooth device.
- Even when “Headphone” is set to “On”, press Bluetooth on the remote control to select the “Bluetooth” source and enable the Bluetooth receiver function.
To listen to music stored on Bluetooth devices such as smartphones on this unit, press Bluetooth on the remote control to switch the input source to Bluetooth, then reconnect the Bluetooth device.
- Menu settings for Bluetooth headphones transmitter are not available when this unit is grouped within the HEOS app.
- Bluetooth headphones cannot be connected if a HEOS Built-in device is playing an input source from this unit.

Network Control

Enables network communication in standby power mode.

On
(Default):

Network is on during standby. Main unit operable with a network compatible controller.

Off:

Suspend network function during standby.



- When using the HEOS app, use with the “Network Control” setting set to “On”.

NOTE

- When “Network Control” is set to “On”, the unit consumes more standby power.



AirPlay Setup

This unit supports the “WAC (Wireless Accessory Configuration)” setup mode of Apple Inc. In the WAC setup mode, use your iOS device (iPhone/iPod/iPad) to connect to the network. By connecting your iOS device with this unit, this unit can be automatically connected to the same network.

1. Select “AirPlay Setup” and press ENTER.
 - This unit switches to the WAC setup mode.
2. At the bottom of the Wi-Fi setup screen for iOS devices, select “Marantz LINK 10n” from “SET UP NEW AIRPLAY SPEAKER...”.
 - Make sure the iOS device is connected to the wireless LAN (Wi-Fi) router.
3. Select a network to connect this device and press “Next”.
4. Follow the on-screen instructions to complete the connection.
 - When connected, “Connected” is shown on the display.

NOTE

- The firmware version of your iOS device must support iOS 10.0.2 or later.
- The WAC setup mode lasts approximately 15 minutes. If the setup is not completed within 15 minutes, the WAC setup mode is canceled automatically. If you cancel the WAC setup mode manually, press the BACK button.



Connecting to the network by using the WPS button on the router

If you are using a wireless router that supports WPS (Wi-Fi Protected Setup™), connect to the network with the “push button method”. (Wi-Fi Protected Setup™ is trademarks of Wi-Fi Alliance.)

- 1 Press the WPS button on your router.**
- 2 Within 2 minutes, press and hold the CONNECT button on the rear panel for 5 seconds.**

“WPS Connecting” is shown on the display and the connection is started.

- When connected, “WPS Connected” is shown on the display.



- You can also press and hold  (HEOS Music) on the remote control for 5 seconds to enter WPS setup mode.



Disabling amplifier/SACD player operating mode on remote control

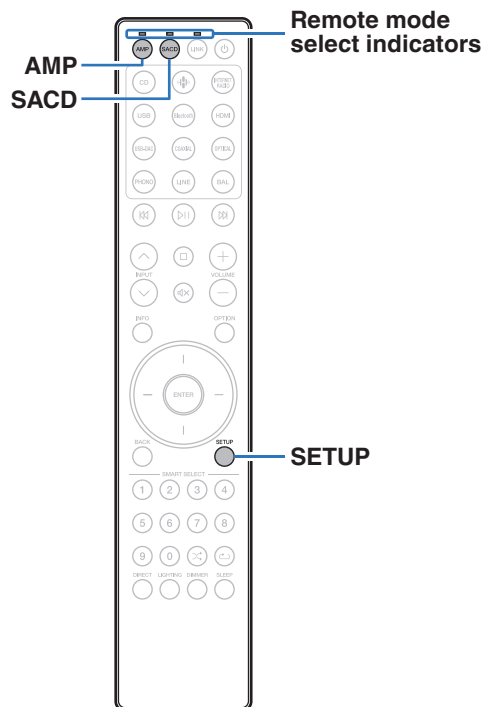

If you do not want to use this unit in combination with MODEL 10 or SACD 10, you can disable the remote control operating mode of the device that you are not using. By default, all remote control operating modes are enabled.



- When remote control operating mode is enabled, be sure to check the operation of your device.



Disabling amplifier operating mode

- 1 Press and hold AMP and SETUP simultaneously until the remote mode select indicators flash green.**
 - Each time you perform Step 1, the amplifier operating mode is toggled between enabled/disabled.

Disabling SACD player operating mode

- 1 Press and hold SACD and SETUP simultaneously until the remote mode select indicators flash green.**
 - Each time you perform Step 1, the SACD player operating mode is toggled between enabled/disabled.



Setting the device to be operated by the volume buttons on the remote control

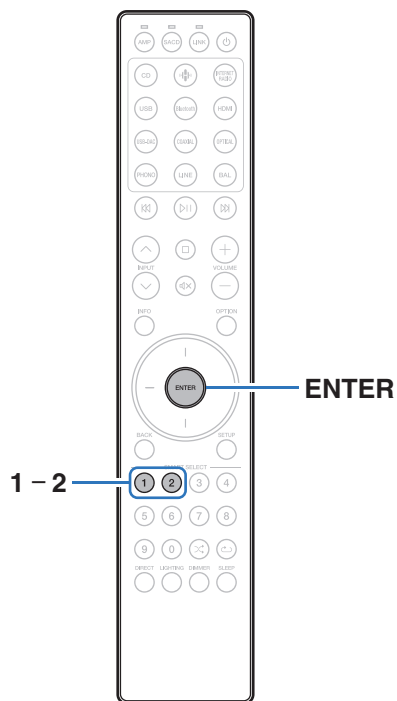

On the included remote control, you can set the device to be operated by the volume buttons so that you can adjust the volume of this unit when it is either in SACD player operating mode. You can also set it to adjust the volume of a connected amplifier in streaming preamplifier operation mode. You can select either “Amplifier” or “Streaming Preamplifier” as the device to be operated by the volume buttons on the remote control.



- After setting the device to be operated by the volume buttons on the remote control, be sure to check the operation of your device.
- Switching the device to be operated affects the VOLUME +— and $\text{M} \times$ buttons on the remote control.



Setting the device to be operated by the volume buttons in streaming preamplifier operating mode

If you use a Marantz amplifier in combination with this unit, you can adjust the volume of the amplifier without switching to amplifier operating mode while the included remote control is set to streaming preamplifier operating mode.

By default, the device to be operated is set to “Streaming Preamplifier”.

■ Set the device to be operated by the volume buttons to this unit (streaming preamplifier)

- 1 Press and hold ENTER and 1 on the remote control simultaneously for 5 seconds or more.

The LINK indicator will flash green.

■ Set the device to be operated by the volume buttons to the amplifier

- 1 Press and hold ENTER and 2 on the remote control simultaneously for 5 seconds or more.

The AMP indicator will flash green.

Setting the device to be operated by the volume buttons in SACD player operating mode

If you use a Marantz SACD player in combination with this unit, you can adjust the volume of this unit without switching to streaming preamplifier operating mode while the included remote control is set to SACD player operating mode.

By default, the device to be operated is set to “Amplifier”.

■ Set the device to be operated by the volume buttons to the amplifier

- 1 Press and hold ENTER and 1 on the remote control simultaneously for 5 seconds or more.

The AMP indicator will flash green.

■ Set the device to be operated by the volume buttons to this unit (streaming preamplifier)

- 1 Press and hold ENTER and 2 on the remote control simultaneously for 5 seconds or more.

The LINK indicator will flash green.



■ Contents

Tips

I want to switch the filter to change the desired sound quality	115
I want to enjoy analog output audio at higher quality	115
I want to listen to high sound performance playback	115
I want to play TV audio at higher quality	115
I want to prevent this unit from going into standby by linking to the power off operation of an HDMI connected TV	115
Simple operations in the power off state	116
I want to connect a power amplifier to this unit	116
I want the volume not to become too loud by mistake	116
I want to adjust the tone myself	116
I want to turn the display off	116
I want to turn off the illumination and display	116
I want to operate a Marantz amplifier and SACD player using the remote control of this unit	116

Troubleshooting

Power does not turn on/Power is turned off	118
Operations cannot be performed through the remote control unit	119
Display on this unit shows nothing	120
No sound comes out	120
Sound is interrupted or noise occurs	121
Desired sound does not come out	122
AirPlay cannot be played back	123
USB flash drives cannot be played back	124
Bluetooth cannot be played back	125
The Internet radio cannot be played back	127
Music files on PC or NAS cannot be played back (Music server)	128
Various online services cannot be played	129
Cannot connect to a wireless LAN network	129
Music files on PC or Mac cannot be played back (USB-DAC)	130
Audio from digital devices cannot be played back (HDMI ARC/Coaxial/Optical 1/2)	131
The input source switches to "HDMI", "Optical 1", "Optical 2" or "Coaxial"	131
The HDMI control function does not work	131
Update/upgrade error messages	132



Tips

I want to switch the filter to change the desired sound quality

- Switch the filter characteristics. (👉 p. 97)

I want to enjoy analog output audio at higher quality

- Set “Digital Out” on the setup menu to “Off”. (👉 p. 99)
- Press the DIMMER button to turn the display off. (👉 p. 91)
- Press the LIGHTING button to turn the illumination and display off. (👉 p. 91)

I want to listen to high sound performance playback

- The Wi-Fi function can be stopped to prevent noise that affects the sound quality. Set “Wi-Fi” to “Off” in the setup menu. (👉 p. 105)
- Stopping Bluetooth function reduces a source of noise that affects sound quality, enabling higher sound quality playback. Set “Bluetooth” to “Off” in the setup menu. (👉 p. 106)

I want to play TV audio at higher quality

- Connect the HDMI terminal of your TV that supports the ARC function to the HDMI (ARC) terminal of this unit and switch the input source to HDMI. (👉 p. 27)
- If you are using a TV that does not support the ARC function or a TV that does not have an HDMI terminal, the TV audio can be played by this unit using an Optical or Coaxial connection. (👉 p. 29)
- Only 2-channel linear PCM can be input as the digital audio signal to this unit.

I want to prevent this unit from going into standby by linking to the power off operation of an HDMI connected TV

- Change the “HDMI Power Off Control” setting to “Off”. (👉 p. 102)



Simple operations in the power off state

- Press the **▶||** button to automatically turn the unit's power supply on and start playback of the last selected input source.
- When the "Network Control" function is set to "On", you can perform playback, or other operations through AirPlay or HEOS app. (👉 p. 107)

I want to connect a power amplifier to this unit

- A power amplifier can be connected to the PREAMP OUT connectors (UNBALANCED/BALANCED) on the rear panel. Set "Preamp Out" to "On" in the setup menu. (👉 p. 98)

I want the volume not to become too loud by mistake

- Set the volume upper limit for "Volume Limit" in the menu beforehand. This prevents children or others from increasing the volume too much by mistake. (👉 p. 99)

I want to adjust the tone myself

- Press the OPTION button to adjust "Tone" setting on the option menu. (👉 p. 89)

I want to turn the display off

- Press the DIMMER button to adjust the display's brightness on the dimmer menu. (👉 p. 91)

I want to turn off the illumination and display

- Press the LIGHTING button to turn off. (👉 p. 91)

I want to operate a Marantz amplifier and SACD player using the remote control of this unit

- Marantz amplifier and SACD player can also be operated with the remote control of this unit. Also refer to the amplifier and SACD player instruction manuals for those players. (👉 p. 19)



Troubleshooting

If a problem should arise, first check the following:

1. Are the connections correct?
2. Is the set being operated as described in the owner's manual?
3. Are the other devices operating properly?



- If steps 1 to 3 above do not improve the problem, restarting the device may improve the problem.
Continue pressing the  button on the unit until "Restarting device" appears in the display, or remove and re-insert the power cord of the unit.



If this unit does not operate properly, check the corresponding symptoms in this section.

If the symptoms do not match any of those described here, consult your dealer as it could be due to a fault in this unit. In this case, disconnect the power immediately and contact the store where you purchased this unit.



Power does not turn on / Power is turned off

Power is not turned on.

- Check whether the power plug is correctly inserted into the power outlet. (👉 p. 40)
- This unit is in standby mode. Press the  button on the main unit or the  button on the remote control. (👉 p. 42)

Power automatically turns off.

- The sleep timer is set. Turn on the power again. (👉 p. 92)
- “Auto-Standby” is set. “Auto-Standby” is triggered when there is no operation for a set amount of time. To disable “Auto-Standby”, set “Auto-Standby” on the menu to “Off”. (👉 p. 104)
- “HDMI Power Off Control” is set. The power of this unit turns off (standby) by linking to the power off operation of an HDMI connected TV. To disable “HDMI Power Off Control”, set “HDMI Power Off Control” on the setup menu to “Off”. (👉 p. 102)

When the power is turned on, the power indicator flashes in orange.

- The protection circuit has been activated due to an error in the internal power supply. Unplug the power cord and contact our customer service center.



Operations cannot be performed through the remote control unit

Operations cannot be performed through the remote control unit.

- Batteries are worn out. Replace with new batteries. (👉 p. 8)
- Operate the remote control unit within a distance of about 23 ft/7 m from this unit and at an angle of within 30°. (👉 p. 8)
- Remove any obstacle between this unit and the remote control unit.
- Insert the batteries in the proper direction, checking the ⊕ and ⊖ marks. (👉 p. 8)
- The unit's remote control sensor is exposed to strong light (direct sunlight, inverter type fluorescent bulb light, etc.). Move the set to a place in which the remote control sensor will not be exposed to strong light.
- When using a 3D video device, the remote control unit of this unit may not function due to effects of infrared communications between units (such as TV and glasses for 3D viewing). In this case, adjust the direction of units with the 3D communications function and their distance to ensure they do not affect operations from the remote control unit of this unit.
- Press the LINK button to switch the remote control operating mode to streaming preamplifier operating mode. (👉 p. 15)
- Remote control streaming preamplifier operating mode is disabled. Press and hold the LINK and SETUP buttons simultaneously for 3 seconds or more to enable streaming preamplifier operating mode.
- The device to be operated by the VOLUME + and MUTE buttons is a Marantz amplifier. If the remote control is in SACD player operation mode and the volume of this unit cannot be adjusted, switch the device to be operated to this unit. (👉 p. 113)
- The device to be operated by the VOLUME + and MUTE buttons is a Marantz amplifier. If the remote control is in streaming preamplifier operation mode and the volume of this unit cannot be adjusted, switch the device to be operated to this unit. (👉 p. 113)
- When using this unit independently, set the switch to INTERNAL. (👉 p. 38)



Display on this unit shows nothing

Display is off.

- Press the DIMMER button, and change the setting to anything other than “Off” on the dimmer menu. (👉 p. 91)
- Set “Illumination” - “Display” on the setup menu to something other than “Off”. (👉 p. 103)
- Press the LIGHTING button to turn on the lighting. (👉 p. 91)

No sound comes out

No sound is produced. Or sound is distorted.

- Check the connections for all devices. (👉 p. 21)
- Insert connection cables all the way in.
- Check that input connectors and output connectors are not reversely connected.
- Check cables for damage.
- Check the amplifier's functions and controls and adjust as necessary.
- When connecting to a device with digital audio input connectors, set “Digital Out” to “On”. (👉 p. 99)
- Digital audio output stops when playing a file with a DSD signal or a linear PCM signal with a sampling frequency of 352.8 kHz or higher.
- The volume is set to the minimum level. Adjust the volume to a suitable level. (👉 p. 43)
- Cancel the muting mode. (👉 p. 44)
- Set “Preamp Out” to “On” in the setup menu when connecting a power amplifier to the PREAMP OUT connectors. (👉 p. 98)



Sound is interrupted or noise occurs

During playback from the Internet radio or USB flash drive, sound is occasionally interrupted.

- When the transfer speed of the USB flash drive is slow, sound may occasionally be interrupted.
- The network communication speed is slow or the radio station is busy.

Sound is interrupted during playback of tracks saved on a computer.

- Do not start applications other than the player software while playing music on your computer.
- The sound may be interrupted depending on the hardware or software configuration of the computer being used.

When making a call on mobile phone, noise occurs in audio output on this unit.

- When making a call, keep a distance of 0.7 ft/20 cm or longer between mobile phone and this unit.

Sound cuts out when using Wi-Fi connection.

- The frequency band used by the wireless LAN is also used by microwave ovens, cordless telephones, wireless game controllers and other wireless LAN devices. Using such devices at the same time as this unit may cause sound to cut out due to electronic interference. Sound cut out can be improved using the following methods. (🔍 p. 35)
 - Install devices that cause interference away from this unit.
 - Turn off the power supply to devices that cause interference.
 - Change the settings of the router channel to which this unit is connected to. (See the instruction manual of the wireless router for details on how to change the channel.)
 - Switch to a wired LAN connection.
- Particularly when you play back large music files, depending on your wireless LAN environment, the playback sound may be interrupted. In this case, make the wired LAN connection. (🔍 p. 105)



When playing a record, the sound is distorted.

- Adjust to a proper needle pressure.
- Check the tip of the needle.
- Replace the cartridge.

When playing a record, a humming noise comes out of the speakers.

- Check that the turntable is connected correctly. (🔗 p. 25)
- If there is a TV or AV device near the turntable, such devices may affect the playback sound. Install the turntable in a location as far away as possible from the TV or other AV devices.

When playing a record, a humming noise comes out of the speakers when the volume is high. (Howling phenomenon)

- Install the turntable and speakers as far from each other as possible. (🔗 p. 25)
- The vibrations from the speakers are being transmitted to the player through the floor. Use cushions, etc., to absorb the speakers' vibrations.

Desired sound does not come out

The volume does not increase.

- The maximum volume of the audio signal output from the PREAMP OUT connectors (UNBALANCED/BALANCED) is set too low. Set the maximum volume using "Volume Limit" on the menu. (🔗 p. 99)

Headphone volume is low.

- Switch "HP Amplifier Gain" to "High" if using headphones with high impedance or low sensitivity. (🔗 p. 99)

The settings of the "Bass", "Treble" and "Balance" are not applied.

- Press the DIRECT button to turn off source direct mode. (🔗 p. 90)

Sound is not correctly output from the power amplifier connected to the PREAMP OUT connectors.

- Check the power amplifier connections. (🔗 p. 22)



AirPlay cannot be played back

The AirPlay icon is not displayed on iTunes / iPhone / iPod touch / iPad / Mac.

- This unit and PC / iPhone / iPod touch / iPad are not connected to the same network (LAN). Connect it to the same LAN as this unit. (🔍 p. 35)
- The firmware on iTunes / iPhone / iPod touch / iPad / Mac is not compatible with AirPlay. Update the firmware to the latest version.

Audio is not output.

- The volume on iTunes / iPhone / iPod touch / iPad / Mac is set to the minimum level. The volume of the audio output from the PREAMP OUT connectors (UNBALANCED/BALANCED) is linked to the volume of your iTunes / iPhone / iPod touch / iPad / Mac. Set a proper volume level.
- The AirPlay playback is not performed, or this unit is not selected. Click the AirPlay icon on the iTunes / iPhone / iPod touch / iPad / Mac screen and select this unit. (🔍 p. 84)

Audio is interrupted during the AirPlay playback on iPhone / iPod touch / iPad / Mac.

- Quit the application running in the background of the iPhone / iPod touch / iPad / Mac, and then play using AirPlay.
- Some external factors may be affecting the wireless connection. Modify the network environment by taking measures such as shortening the distance from the wireless LAN access point.



USB flash drives cannot be played back

USB flash drive is not recognized.

- Disconnect and reconnect the USB flash drive. (👉 p. 34)
- Mass storage class compatible USB flash drives are supported.
- This unit does not support a connection through a USB hub. Connect the USB flash drive directly to the USB port.
- The USB flash drive must be formatted to FAT32 or NTFS.
- Not all USB flash drives are guaranteed to work. Some USB flash drives are not recognized. When using a type of portable hard disc drive compatible with the USB connection that requires power from an AC adapter, use the AC adapter that came with the drive.

Files on the USB flash drive are not displayed.

- Files of a type not supported by this unit are not displayed. (👉 p. 50)
- This unit is able to display files in a maximum of eight folder layers. A maximum of 5000 files (folders) can also be displayed for each layer. Modify the folder structure of the USB flash drive.
- When multiple partitions exist on the USB flash drive, only files on the first partition are displayed.

iOS and Android devices are not recognized.

- The USB port of this unit does not support playback from iOS and Android devices.

Files on a USB flash drive cannot be played.

- Files are created in a format that is not supported by this unit. Check the formats supported by this unit. (👉 p. 135)
- You are attempting to play a file that is copyright protected. Files that are copyright protected cannot be played on this unit.
- Playback may not be possible if the album art file size exceeds 2 MB.



Bluetooth cannot be played back

Bluetooth devices cannot be connected to this unit.

- The Bluetooth function in the Bluetooth device has not been enabled. See the Owner's Manual of the Bluetooth device to enable the Bluetooth function.
- Bring the Bluetooth device near to this unit.
- The Bluetooth device cannot connect with this unit if it is not compatible with the A2DP profile.
- Turn the power of the Bluetooth device off and on again, and then try again.
- Set "Bluetooth" in the setup menu to "On". The Bluetooth function does not work when "Bluetooth" is "Off". (🔧 p. 106)

Smartphones and other Bluetooth devices cannot be connected.

- Smartphones and other Bluetooth devices cannot be connected when "Headphone" is set to "On". Press Bluetooth on the remote control to switch the input source to Bluetooth, then connect the device. (🔧 p. 106)

Cannot connect Bluetooth headphones.

- Bring the Bluetooth headphones near to this unit.
- Turn the power of the Bluetooth headphones off and on again, and then try again.
- Go to "Network" - "Bluetooth", and set "Headphone" to "On" within the setup menu. (🔧 p. 106)
- Make sure this unit is not already connected to another pair of Bluetooth headphones. Check the currently connected Bluetooth headphones in the "Devices" menu. (🔧 p. 106)
Disconnect the connected Bluetooth headphones before connecting the ones you want to use.
- Bluetooth headphones cannot be connected if Bluetooth is being used as an input source.
- Bluetooth headphones cannot be connected if this unit is grouped in the HEOS app. Remove this unit from the group to enable Bluetooth headphones connection.
- Bluetooth headphones cannot be connected if a HEOS Built-in device is playing an input source from this unit.
- The Bluetooth headphones cannot connect with this unit if it is not compatible with the A2DP profile.
- Connection and operation are not guaranteed for all Bluetooth-enabled devices.
- This unit can only connect to one Bluetooth headphone at a time. However, up to 8 Bluetooth headphones can be registered. You can switch between registered devices from "Devices" in the "Bluetooth" menu. (🔧 p. 106)



The sound is cut off.

- Bring the Bluetooth device near to this unit.
- Remove obstructions between the Bluetooth device and this unit.
- To prevent electromagnetic interference, locate this unit away from microwave ovens, wireless LAN devices and other Bluetooth devices.
- Reconnect the Bluetooth device.

The sound is cut off or noise occurs when using Bluetooth headphones.

- Move the Bluetooth headphones closer to this unit.
- Remove obstructions between the Bluetooth headphones and this unit.
- Reconnect the Bluetooth headphones.
- To prevent electromagnetic interference, locate this unit away from microwave ovens, wireless LAN devices and other Bluetooth devices.
- We recommend using wired LAN to connect this unit and other devices.
- Bluetooth transmits on the 2.4 GHz band which may interfere with Wi-Fi transmitted on this band. Connect this unit and other devices to Wi-Fi network on a 5 GHz band if available on your Wi-Fi router.

Audio is delayed on my Bluetooth headphones.

- This unit cannot adjust audio delay on Bluetooth headphones.



The Internet radio cannot be played back

A list of broadcasting stations is not displayed.

- The LAN cable is not properly connected, or the network is disconnected. Check the connection status. (👉 p. 35)

Internet Radio cannot be played.

- The selected radio station is broadcasting in a format that is not supported by this unit. Formats that can be played back in this unit are WMA, MP3 and MPEG-4 AAC. (👉 p. 140)
- The firewall function is enabled on the router. Check the firewall setting.
- Check the power of the router is on.
- Some radio stations broadcast silently during some time period. In this case, no audio is output. Wait for a while and select the same radio station, or select another radio station. (👉 p. 46)
- The selected radio station is not in service. Select a radio station in service.

Cannot connect to favorite radio stations.

- Radio station is not currently in service. Register radio stations in service.



Music files on PC or NAS cannot be played back (Music server)

Files stored on a computer cannot be played.

- Files are stored in a non-compatible format. Record in a compatible format. (👉 p. 138)
- Files that are copyright protected cannot be played on this unit.
- Even if PC is connected to the USB port on this unit, music files on it cannot be played back. Connect PC to this unit through the network. (👉 p. 35)
- Media sharing settings on the server or NAS do not allow this unit. Change the settings to allow this unit. For details, see the owner's manual of the server or NAS.

Server is not found, or it is not possible to connect to the server.

- The computer's or router's firewall is activated. Check the computer's or router's firewall settings.
- Computer's power is not turned on. Turn on the power.
- Server is not running. Launch the server.

Files on PC or NAS are not displayed.

- Files of a type not supported by this unit are not displayed. (👉 p. 138)

Music stored on a NAS cannot be played.

- If you use a NAS in conformity with the DLNA standard, enable the DLNA server function in the NAS setting.
- If you use a NAS that does not conform with the DLNA standard, play the music via a PC. Set Windows Media Player's media sharing function and add NAS to the selected play folder.
- If connection is restricted, set audio equipment as the connection target.



Various online services cannot be played

Various online services cannot be played.

- The online service may have been discontinued.

Cannot connect to a wireless LAN network

Cannot connect to the network.

- Make sure your mobile device is connected to your wireless network before setting up this unit. (🔍 p. 61)
- You can connect this unit to your network router using an Ethernet cable sold separately. Once connected via Ethernet, the HEOS app should recognize this unit and you can manually move it to your wireless network using “Settings” - “My Devices” - (“Device Name”) - “Network”.
- Shorten the distance from the wireless LAN access point and remove any obstructions to improve access first before re-connecting again. Place the unit away from microwave ovens and other network access points.
- Configure the access point channel settings away from channels that are being used by other networks.
- This unit is not compatible with WEP (TSN).

Cannot connect to a WPS Router.

- Check that the WPS mode of the router is operating.
- After you press the WPS button on the router, within two minutes, press and hold the CONNECT button on the rear panel for 5 seconds. (🔍 p. 109)
- A router/settings that are compatible with WPS 2.0 standards are required. Set the encryption time to “None”, WPA-PSK (AES) or WPA2-PSK (AES).
- If the router encryption method is WEP/WPA-TKIP/WPA2-TKIP, you cannot connect by using the WPS button on the router. In this case, connect using the HEOS app or connect by sharing the Wi-Fi setting of your iOS device. (🔍 p. 109)

Cannot connect to the network using iPhone/iPod touch/iPad.

- Update the iPhone/iPod touch/iPad firmware to the latest version.
- When configuring the settings via a wireless connection, iOS 10.0.2 or later needs to be supported.

Cannot connect to the network during standby.

- Set “Network Control” of the settings menu to “On”. If “Network Control” is set to “Off”, the network function is suspended during standby. (🔍 p. 107)



Music files on PC or Mac cannot be played back (USB-DAC)

This unit is not recognized on the computer.

- Reconnect the USB cable to the USB port on your computer. When this unit is still not recognized after reconnection, connect to a different USB port. (👉 p. 33)
- Restart your computer.
- Check the OS of your computer. (👉 p. 72)
- When your computer is running on Windows, a dedicated driver software should be installed. (👉 p. 73)

This unit is not selected as the playback device.

- Select this unit as the playback device in the sound settings on the computer. (👉 p. 72)

“Signal Unlock” is displayed.

- When digital audio signals cannot be detected properly, “Signal Unlock” is displayed. (👉 p. 80)

“Unsupported Format” is displayed.

- “Unsupported Format” is displayed when audio signals that are not supported by this unit are input. Check the settings on your computer or player software. (👉 p. 80)
- If the computer you use is macOS, please check if the LINK 10n format is set below 384.0 kHz using the Audio MIDI Setup. (👉 p. 79)



Audio from digital devices cannot be played back (HDMI ARC/Coaxial/Optical 1/2)

“Signal Unlock” is displayed.

- When digital audio signals cannot be detected properly, “Signal Unlock” is displayed. (🔍 p. 70)

“Unsupported Format” is displayed.

- “Unsupported Format” is displayed when audio signals that are not supported by this unit are input. Check the audio output signal format from your digital device. (🔍 p. 70)
- Only the PCM 2-channel setting can be used to play sound from a TV via the HDMI ARC function. Set “PCM 2ch” as the audio format in the TV settings.

The input source switches to “HDMI”, “Optical 1”, “Optical 2” or “Coaxial”

The input source automatically switches to “HDMI”, “Optical 1”, “Optical 2” or “Coaxial” when the TV connected to this unit is turned on.

- Set “Off” to “Auto-Play”. (🔍 p. 101)

The HDMI control function does not work

The HDMI control function does not work.

- You cannot operate devices that are not compatible with the HDMI control function. In addition, depending on the connected device or the settings, the HDMI control function may not work. In this case, operate the external device directly.
- Check that the HDMI control function setting is enabled on TV connected to this unit.



Update/upgrade error messages

If an update/upgrade is interrupted or fails, an error message appears.

Display	Description
Connection failed. Please check your network, then try again.	The network connection is unstable. Connection to the server failed. Check your network environment and try the update again.
Update failed. Please check your network, then try again.	The download of the firmware failed. Check your network environment and try the update again.
Upgrade failed. Please check your network, then try again.	The download of the firmware failed. Check your network environment and try the upgrade again.
Please check your network, unplug and reconnect the power cord, and try again.	The update failed. Press and hold the  on the main unit for more than 5 seconds, or remove and re-insert the power cord. The update restarts automatically.
Please contact customer service in your area.	This unit may be broken. Contact our Customer Service Center in your area.



Resetting network settings



If network contents cannot be played or the unit cannot connect to the network, restarting the unit may improve the problem. We recommend restarting the unit before returning the settings to the default settings. (☞ p. 117)

If the operations are not improved by restarting the unit, follow the steps below.

Network settings are reset to the factory default values. Make settings again.

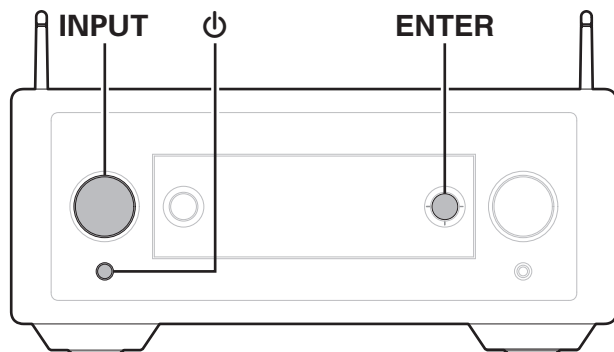
However, the menu “Audio” settings are not reset.



- 1** Press  on the main unit to turn on power to the unit.
- 2** Turn the INPUT selector to select “HEOS”, then press ENTER.
- 3** When the power to this unit is on, press and hold  for 3 seconds or more while pressing ENTER on the main unit.
- 4** Remove your fingers from the two buttons when “Please Wait...” appears on the display.
- 5** “Complete” is shown in the display when reset is complete.

NOTE

- Do not turn the power off until reset is complete.



Factory Restore

When the unit or the network functions do not work properly, operation may be improved by restoring the firmware to the factory defaults.

Perform this operation if it does not work after attempting “General” - “Reset” of the settings menu. (🔍 p. 104)

After performing the Factory Restore, various settings are reset to the default settings. Configure the network settings and update the firmware again.

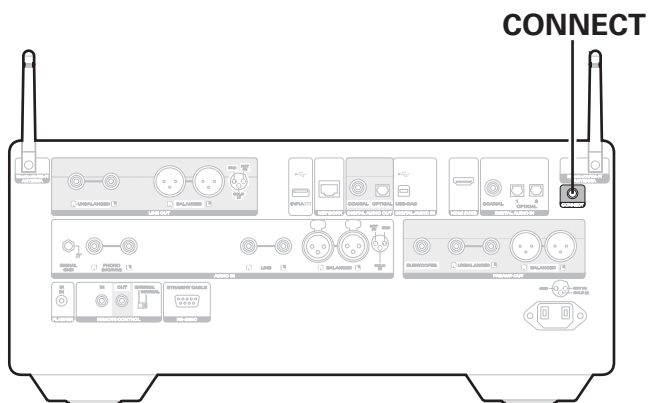

- 1 Unplug the power cord from the power outlet.**
- 2 Plug in the power cord while holding down CONNECT.**
- 3 When “Factory Restore” appears on the display, release the buttons.**

When the Factory Restore is complete, this unit automatically restarts.



- This operation takes time because it requires reconnecting to the network, restoring and updating the firmware.
- If this operation does not improve the problem, contact our customer service center.

NOTE

- Do not turn off the power until the Factory Restore is complete.

WARNING

By initiating Factory Restore mode, you will be installing limited recovery firmware on this unit. Functionality will remain limited until a firmware update is performed over the Internet. Do not perform a Factory Restore if you do not have this unit connected to your home network.



Playing back a USB flash drives

- This unit is compatible with MP3 ID3-Tag (Ver. 2) standard.
- This unit is compatible with WMA META tags.
- If the image size (pixels) of an album artwork exceeds 500 × 500 (WMA/MP3/Apple Lossless/DSD) or 349 × 349 (MPEG-4 AAC), then music may not be played back properly.

■ Specifications of supported files

	Sampling frequency	Bit rate	Extension
WMA*1	32/44.1/48 kHz	48 – 192 kbps	.wma
MP3	32/44.1/48 kHz	32 – 320 kbps	.mp3
WAV	32/44.1/48/88.2/96/ 176.4/192/352.8/384 kHz	–	.wav
MPEG-4 AAC*1	32/44.1/48 kHz	48 – 320 kbps	.aac/.m4a
FLAC	44.1/48/88.2/96/ 176.4/192/352.8/384 kHz	–	.flac
Apple Lossless*2	44.1/48/88.2/96/ 176.4/192/352.8/384 kHz	–	.m4a
DSD	2.8/5.6/11.2 MHz*3	–	.dsf/.dff

*1 Only files that are not protected by copyright can be played on this unit.

Content downloaded from pay sites on the Internet are copyright protected. Also, files encoded in WMA format when ripped from a CD, etc. on a computer may be copyright protected, depending on the computer's settings.

*2 The Apple Lossless Audio Codec (ALAC) decoder is distributed under the Apache License, Version 2.0 (<http://www.apache.org/licenses/LICENSE-2.0>).

*3 The sampling frequency of DSD, 11.2MHz, will be supported by a firmware update.



■ Maximum number of playable files and folder

The limits on the number of folders and files that can be displayed by this unit are as follows.

Item	Media	USB flash drive
Number of folder directory levels *1		8 levels
Number of folders		500
Number of files*2		5000
Maximum file size of one audio file		2 GB

*1 The limited number includes the root folder.

*2 The allowable number of files may differ according to the USB flash drive capacity and the file size.

NOTE

- Digital audio output stops during playback of the DSD files.

Digital input

■ Specifications of supported audio formats

□ USB-DAC

	Sampling frequency	Bit length
DSD (2-channel)	2.8/5.6/ 11.2 MHz	1 bit
Linear PCM (2-channel)	44.1/48/88.2/96/ 176.4/192/352.8/ 384 kHz	16/24/32 bits



- Digital audio output stops during playback of the DSD files and linear PCM signals with a sampling frequency of 352.8/384 kHz.

□ HDMI ARC

	Sampling frequency	Bit length
Linear PCM (2-channel)	32/44.1/48/88.2/96/ 176.4/192 kHz	16/20/24 bits

□ Coaxial/Optical

	Sampling frequency	Bit length
Linear PCM (2-channel)	44.1/48/88.2/96/ 176.4/192 kHz	16/24 bits



Playing back a Bluetooth device

This unit supports the following Bluetooth profile.

- A2DP (Advanced Audio Distribution Profile):
When a Bluetooth device that supports this standard is connected, monaural and stereo sound data can be streamed at a high quality.
- AVRCP (Audio/Video Remote Control Profile):
When a Bluetooth device that supports this standard is connected, the Bluetooth device can be operated from this unit.

■ About Bluetooth communications

Radio waves broadcast from this unit may interfere with the operation of medical devices. Make sure you turn off the power of this unit and Bluetooth device in the following locations as radio wave interference may cause malfunctions.

- Hospitals, trains, aircraft, petrol kiosks and places where flammable gases are generated
- Near automatic doors and fire alarms



Playing back files stored on a PC and NAS

- This unit is compatible with MP3 ID3-Tag (Ver. 2) standard.
- This unit is compatible with WMA META tags.
- If the image size (pixels) of an album artwork exceeds 500 × 500 (WMA/MP3/WAV/FLAC) or 349 × 349 (MPEG-4 AAC), then music may not be played back properly.
- A server or server software compatible with distribution in the corresponding formats is required to play music files via a network.
- The maximum size of audio file that can be played on this unit is 2 GB per file.

For playing mentioned audio formats via a network a server software, for example Twonky Media Server or jRiver Media Server, needs to be installed on your computer or NAS for full support. There are other server software available too. Please check supported formats.



■ Specifications of supported files

	Sampling frequency	Bit rate	Extension
WMA*1	32/44.1/48 kHz	48 – 192 kbps	.wma
MP3	32/44.1/48 kHz	32 – 320 kbps	.mp3
WAV	32/44.1/48/88.2/96/ 176.4/192/352.8/384 kHz	–	.wav
MPEG-4 AAC*1	32/44.1/48 kHz	48 – 320 kbps	.aac/.m4a
FLAC	44.1/48/88.2/96/ 176.4/192/352.8/384 kHz	–	.flac
Apple Lossless*2	44.1/48/88.2/96/ 176.4/192/352.8/384 kHz	–	.m4a
DSD	2.8/5.6/11.2 MHz*3	–	.dsf/.dff

*1 Only files that are not protected by copyright can be played on this unit.

Content downloaded from pay sites on the Internet are copyright protected. Also, files encoded in WMA format when ripped from a CD, etc., on a computer may be copyright protected, depending on the computer's settings.

*2 The Apple Lossless Audio Codec (ALAC) decoder is distributed under the Apache License, Version 2.0 (<http://www.apache.org/licenses/LICENSE-2.0>).

*3 The sampling frequency of DSD, 11.2MHz, will be supported by a firmware update.

NOTE

- Digital audio output stops during playback of the DSD files.



Playing back Internet Radio

■ Playable broadcast station specifications

	Sampling frequency	Bit rate	Extension
WMA	32/44.1/48 kHz	48 – 192 kbps	.wma
MP3	32/44.1/48 kHz	32 – 320 kbps	.mp3
MPEG-4 AAC	32/44.1/48 kHz	48 – 320 kbps	.aac/ .m4a

Last function memory

This function stores the settings which were made before going into the standby mode.



About HDMI

This unit supports the following HDMI functions.

- **ARC (Audio Return Channel) function**

Enjoy movies, music, etc., on your TV simply by connecting an ARC function-compatible TV to this unit via HDMI.

- **HDMI control function**

Connect an HDMI control-compatible TV and this unit via HDMI and enable the HDMI control to enable linked control from either device.

- Input source switching

If the TV is turned on, this unit automatically powers on and switches the input source to "HDMI".

- Power off link

The TV power off operation is linked so this unit also turns off.

- Volume adjustment

Use the remote control unit to adjust the volume for the audio signal output from the analog audio output terminals (PREAMP OUT) of this unit.

- Audio output destination switching

If this unit is turned on, TV audio is output from this unit. If this unit is turned off, TV audio is output from the speakers of the TV.



- Some functions may not operate depending on the connected TV.



Explanation of terms

■ Audio

AIFF (Audio Interchange File Format)

This is an uncompressed and lossless format for digital audio. Use AIFF files to burn high-quality audio CDs from imported songs. AIFF files use approximately 10 MB of disk space per minute.

Apple Lossless Audio Codec

This is a codec for lossless audio compression method developed by Apple Inc. This codec can be played back on iTunes, iPod or iPhone. Data compressed to approximately 60 – 70 % can be decompressed to exactly the same original data.

DSD (Direct-Stream Digital)

One of the audio data recording methods, it is the signal aspect used to store audio signals on a super audio CD, and is Δ - Σ modulated digital audio.

FLAC (Free Lossless Audio Codec)

FLAC stands for Free lossless Audio Codec, and is a lossless free audio file format. Lossless means that the audio is compressed without any loss in quality.

The FLAC license is as shown below.

Copyright (C) 2000,2001,2002,2003,2004,2005,2006,2007,2008,2009
Josh Coalson

Redistribution and use in source and binary forms, with or without modification, are permitted provided that the following conditions are met:

- Redistributions of source code must retain the above copyright notice, this list of conditions and the following disclaimer.
- Redistributions in binary form must reproduce the above copyright notice, this list of conditions and the following disclaimer in the documentation and/or other materials provided with the distribution.
- Neither the name of the Xiph.org Foundation nor the names of its contributors may be used to endorse or promote products derived from this software without specific prior written permission.



THIS SOFTWARE IS PROVIDED BY THE COPYRIGHT HOLDERS AND CONTRIBUTORS "AS IS" AND ANY EXPRESS OR IMPLIED WARRANTIES, INCLUDING, BUT NOT LIMITED TO, THE IMPLIED WARRANTIES OF MERCHANTABILITY AND FITNESS FOR A PARTICULAR PURPOSE ARE DISCLAIMED. IN NO EVENT SHALL THE FOUNDATION OR CONTRIBUTORS BE LIABLE FOR ANY DIRECT, INDIRECT, INCIDENTAL, SPECIAL, EXEMPLARY, OR CONSEQUENTIAL DAMAGES (INCLUDING, BUT NOT LIMITED TO, PROCUREMENT OF SUBSTITUTE GOODS OR SERVICES; LOSS OF USE, DATA, OR PROFITS; OR BUSINESS INTERRUPTION) HOWEVER CAUSED AND ON ANY THEORY OF LIABILITY, WHETHER IN CONTRACT, STRICT LIABILITY, OR TORT (INCLUDING NEGLIGENCE OR OTHERWISE) ARISING IN ANY WAY OUT OF THE USE OF THIS SOFTWARE, EVEN IF ADVISED OF THE POSSIBILITY OF SUCH DAMAGE.

Linear PCM

This is an uncompressed PCM (Pulse Code Modulation) signal. Unlike lossy compression audio sources such as MP3, no audio quality or dynamic range deteriorates.

MP3 (MPEG Audio Layer-3)

This is an internationally standardized audio data compression scheme, using the "MPEG-1" video compression standard. It compresses the data volume to about one eleventh its original size while maintaining sound quality equivalent to a music CD.

MPEG (Moving Picture Experts Group), MPEG-2, MPEG-4

These are the names for digital compression format standards used for the encoding of video and audio. Video standards include "MPEG-1 Video", "MPEG-2 Video", "MPEG-4 Visual", "MPEG-4 AVC". Audio standards include "MPEG-1 Audio", "MPEG-2 Audio", "MPEG-4 AAC".

WMA (Windows Media Audio)

This is the audio compression technology developed by Microsoft Corporation.

WMA data can be encoded using Windows Media® Player.

To encode WMA files, only use applications authorized by Microsoft Corporation. If you use an unauthorized application, the file may not work properly.



Sampling frequency

Sampling involves taking a reading of a sound wave (analog signal) at regular intervals and expressing the height of the wave at each reading in digitized format (producing a digital signal).

The number of readings taken in one second is called the “sampling frequency”. The larger the value, the closer the reproduced sound is to the original.

Dynamic range

The difference between the maximum undistorted sound level and the minimum discernible level above the noise emitted by the device.

Bit rate

This expresses the read amount per 1 second of video/audio data recorded in a disc. A larger number means higher sound quality, but also means a larger file size.

■ Network

AirPlay

AirPlay sends (plays) contents recorded in iTunes or on an iPhone / iPod touch / iPad / Mac to a compatible device via the network.

WEP Key (network key)

This is key information used for encrypting data when conducting data transfer. On this unit, the same WEP key is used for data encryption and decryption, so the same WEP key must be set on both devices in order for communications to be established between them.

Wi-Fi®

Wi-Fi Certification assures tested and proven interoperability by the Wi-Fi Alliance, a group certifying interoperability among wireless LAN devices.

WPA (Wi-Fi Protected Access)

This is a security standard established by the Wi-Fi Alliance. In addition to the conventional SSID (network name) and WEP key (network key), it also uses a user identification function and encrypting protocol for stronger security.

WPA2 (Wi-Fi Protected Access 2)

This is a new version of the WPA established by the Wi-Fi Alliance, compatible with more secure AES encryption.



WPA/WPA2-Personal

This is a simple authentication system for mutual authentication when a preset character string matches on the wireless LAN access point and client.

WPA2/WPA3-Personal

WPA2/WPA3-Personal Mode was defined by Wi-Fi Alliance® to minimize user disruption and provide a gradual migration path to WPA3-Personal while maintaining interoperability with WPA2-Personal only devices.

WPA3-Personal

WPA3-Personal replaces the WPA2-Personal Pre-Shared Key (PSK) authentication with Simultaneous authentication of equals (SAE). Unlike PSK, SAE is resistant to offline dictionary attacks.

Network Names (SSID: Service Set Identifier)

When forming wireless LAN networks, groups are formed to prevent interference, data theft, etc. These groups are based on “SSID (network names)”. For enhanced security, a WEP key is set so that communication is unavailable unless both the “SSID” and the WEP key match. This is suitable for constructing a simplified network.

■ Other

Source direct

Playback with higher fidelity to the source becomes possible, as input audio signals are output by bypassing the audio quality-control circuits (BASS/TREBLE/BALANCE).

Pairing

Pairing (registration) is an operation that is required in order to connect a Bluetooth device to this unit using Bluetooth. When paired, the devices authenticate each other and can connect without mistaken connections occurring.

When using Bluetooth connection for the first time, you need to pair this unit and the Bluetooth device to be connected.

Protection circuit

This is a function to prevent damage to devices within the power supply when an abnormality such as an overload, excess voltage occurs or over temperature for any reason.

MM/MC cartridge

There are two types--MM (Moving Magnet) and MC (Moving Coil)--of cartridges for turntable. As the output levels for these two types of cartridges differ, the setting of the phono equalizer that is mounted in this unit must be switched according to the type of cartridge for your turntable. Change this setting in the “Phono” section of the setup menu. (🔧 p. 100)



Trademark information



Apple, AirPlay, iPad, iPad Air, iPad Pro, iPhone and Mac are trademarks of Apple Inc., registered in the U.S. and other countries.

The trademark "iPhone" is used in Japan with a license from Aiphone K.K.

Use of the Works with Apple badge means that an accessory has been designed to work specifically with the technology identified in the badge and has been certified by the developer to meet Apple performance standards.



The Bluetooth® word mark and logos are registered trademarks owned by the Bluetooth SIG, Inc. and any use of such marks by DEI Sales, Inc. is under license. Other trademarks and trade names are those of their respective owners.



The Wi-Fi CERTIFIED logo is a registered trademark of the Wi-Fi Alliance.

Wi-Fi Certification provides assurance that the device has passed the interoperability test conducted by the Wi-Fi Alliance, a group that certifies interoperability among wireless LAN devices.



The terms HDMI, HDMI High-Definition Multimedia Interface, HDMI trade dress and the HDMI Logos are trademarks or registered trademarks of HDMI Licensing Administrator, Inc.





App Store® is registered in the U.S. and other countries.



Google Play and the Google Play logo are trademarks of Google LLC.

ROON READY

Being Roon Ready means that Marantz uses Roon streaming technology, for an incredible user interface, simple setup, rock-solid daily reliability, and the highest levels of audio performance, without compromise.



Specifications

■ Audio section

• Analog audio (PREAMP OUT)

Rated output voltage/Output impedance:

UNBALANCED: 1.58 V / 30 Ω /ohms

BALANCED: 3.16 V / 140 Ω /ohms

SUBWOOFER: 240 mV / 1.16 k Ω /kohms

Maximum output voltage:

UNBALANCED: 10 V (1 kHz, T.H.D. 0.05 %)

BALANCED: 20 V (1 kHz, T.H.D. 0.05 %)

Headphone rated output:

130 mW (32 Ω /ohms load, 1 kHz, T.H.D. 0.7 %)

Distortion (T.H.D.+N) (20 Hz - 20 kHz) :

0.001 %

Frequency response:

5 Hz – 100 kHz (+0 dB/-3 dB)

Input sensitivity/Input impedance:

PHONO (MC - Low): 400 μ V / 32 Ω /ohms

PHONO (MC - Mid): 400 μ V / 100 Ω /ohms

PHONO (MC - High): 400 μ V / 390 Ω /ohms

PHONO (MM): 3.6 mV / 39 k Ω /kohms

BALANCED: 700 mV / 33 k Ω /kohms

LINE: 350 mV / 47 k Ω /kohms

Maximum allowable PHONO input level (1 kHz):

MC: 8 mV

MM: 80 mV

RIAA deviation (20 Hz – 20 kHz):

\pm 0.5 dB

S/N (IHF-A):

PHONO (MC): 76 dB (0.5 mV Input)

PHONO (MM): 88 dB (5 mV Input)

BALANCED: 122 dB (4 V Input, Rated output)

LINE: 122 dB (2 V Input, Rated output)

Tone control:

BASS (50 Hz) \pm 10 dB

TREBLE (15 kHz) \pm 10 dB



- | | | | |
|--|---|--|--------------------------------------|
| <ul style="list-style-type: none"> • Digital audio (LINE OUT) | Channels: | [PCM]
2-channels | [DSD]
2-channels |
| | Output voltage: | UNBALANCED: 2.0 V
BALANCED: 4.0 V | UNBALANCED: 2.0 V
BALANCED: 4.0 V |
| Distortion (T.H.D.+N) (1 kHz): | 0.0015 % (Audible range) | 0.0004 % (Audible range) | |
| Playable frequency range: | 2 Hz – 96 kHz | 2 Hz – 100 kHz | |
| Playable frequency response: | 2 Hz – 50 kHz (-3 dB)
(sampling frequency: 192 kHz)
2 Hz – 20 kHz (± 1 dB)
(sampling frequency: 44.1 kHz) | 2 Hz – 50 kHz (-3 dB) | |
| S/N: | 113 dB (Audible range) | 116 dB (Audible range) | |
| Dynamic range: | 112 dB (Audible range) | 112 dB (Audible range) | |
| <ul style="list-style-type: none"> • Digital audio (DIGITAL AUDIO OUT) | Digital output (COAXIAL): | [PCM]
0.5 V _{p-p} / 75 Ω /ohms | [DSD]
- |
| | Digital output (OPTICAL): | -19 dBm | - |
| <ul style="list-style-type: none"> • Digital audio (DIGITAL AUDIO IN) | COAXIAL: | 0.5 V _{p-p} / 75 Ω /ohms | |
| | OPTICAL: | -27 dBm or later | |
| | USB: | USB Type A (USB 2.0 High speed) | |
| | | USB Type B (USB 2.0 High speed) | |



■ Wireless LAN section

Network type (wireless LAN standard):	Conforming to IEEE 802.11a/b/g/n/ac (Wi-Fi® compliant) *1
Security:	WEP 64 bit, WEP 128 bit WPA/WPA2-PSK (AES) WPA/WPA2-PSK (TKIP) WPA3-SAE (AES)
Used frequency range:	2.4 GHz, 5 GHz

*1 The Wi-Fi® CERTIFIED Logo and the Wi-Fi CERTIFIED On-Product Logo are registered trademarks of the Wi-Fi Alliance.

■ Bluetooth section

Communications system:	Bluetooth Specification Version 5.4
Transmission power:	Bluetooth Specification Power Class 1
Maximum communication range:	Approx. 98.4 ft/30 m in line of sight *2
Used frequency range:	2.4 GHz
Modulation scheme:	FHSS (Frequency-Hopping Spread Spectrum)
Supported profiles:	Receiver function A2DP (Advanced Audio Distribution Profile) 1.4 AVRCP (Audio Video Remote Control Profile) 1.5 Transmitter function A2DP (Advanced Audio Distribution Profile) 1.4
Corresponding codec:	SBC
Transmission range (A2DP):	20 Hz – 20,000 Hz

*2 The actual communication range varies depending on the influence of such factors as obstructions between devices, electromagnetic waves from microwave ovens, static electricity, cordless phones, reception sensitivity, antenna performance, operating system, application software etc.



■ General

Operating temperature:	41 °F - 95 °F (5 °C - 35 °C)
Power supply:	AC 120 V, 60 Hz
Power consumption:	75 W
Power consumption in standby mode :	0.3 W
Power consumption in “Network Control” – “On” mode:	2 W

For the purpose of improvement, the specifications and design are subject to change without notice.



■ Dimensions (Unit : in. (mm))

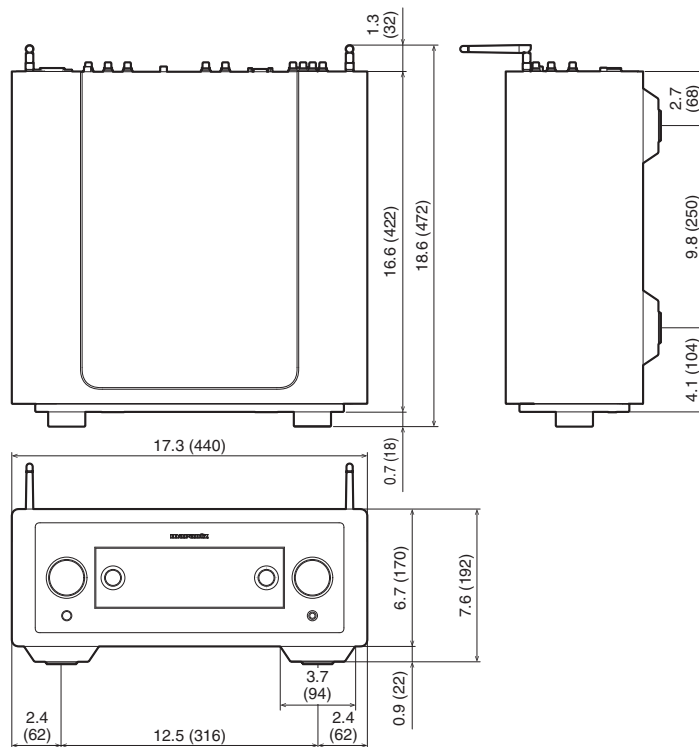

■ Weight : 73 lbs 7 oz (33.3 kg)



Index

A			
AirPlay	83		
Amplifier	22, 31		
Auto Standby	104		
B			
Bluetooth device	53		
D			
D/A converter function	70, 136		
Display's brightness	91		
E			
External control device	37		
F			
Front panel	9		
H			
HEOS Account	63		
HEOS Favorites	88		
I			
Input source	43		
		Internet Radio	45
M			
Menu map	94		
N			
NAS	47, 138		
Network settings	105		
P			
Pairing	53		
PC	35, 47, 138		
Power amplifier	22		
R			
Rear panel	12		
Remote control unit	15		
Resetting network settings	133		
S			
Sleep timer	92		
Spotify	86		
T			
Tips	115		
Troubleshooting	117		
TV	27		
		U	
		USB flash drive	34, 50
		USB-DAC	33, 72, 136
		W	
		Wired LAN	35
		Wireless LAN	36



marantz

3520 10989 00ASC

© 2024 Masimo. All Rights Reserved.