

# marantz

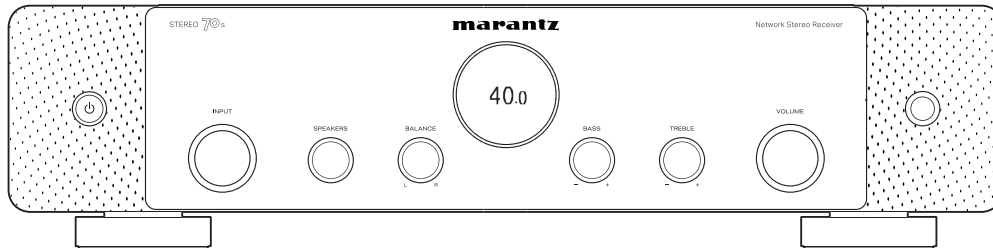

STEREO 70s | Network Stereo Receiver

Owner's Manual

<b>Accessories</b>	<b>8</b>	<b>Connecting a TV</b>	<b>34</b>
Inserting the batteries	9	Connection 1 : TV equipped with an HDMI connector and compatible with the ARC (Audio Return Channel)	35
Operating range of the remote control unit	9	Connection 2 : TV equipped with an HDMI connector and incompatible with the ARC (Audio Return Channel)	36
<b>Features</b>	<b>10</b>	<b>Connecting a playback device</b>	<b>37</b>
High quality sound	10	Connecting a set-top box (Satellite tuner/cable TV)	38
High performance	10	Connecting a media player	39
Easy operation	15	Connecting a Blu-ray Disc player or DVD player	40
<b>Part names and functions</b>	<b>16</b>	Connecting a game console or player device compatible with 8K	41
Front panel	16	Connecting a turntable	42
Display	18	<b>Connecting a USB memory device to the USB port</b>	<b>43</b>
Rear panel	20	<b>Connecting FM/AM antennas</b>	<b>44</b>
Remote control unit	23	<b>Connecting to a home network (LAN)</b>	<b>46</b>
<b>Connections</b>		Wired LAN	46
<b>Speaker installation</b>	<b>27</b>	Wireless LAN	47
<b>Connecting speakers</b>	<b>28</b>	<b>Connecting an external control device</b>	<b>48</b>
Before connecting speakers	28	REMOTE CONTROL jacks	48
Connecting 2.1-channel speakers	30	FLASHER IN jack	50
Second pair of speaker	31	<b>Connecting the power cord</b>	<b>51</b>
Bi-wiring connection	32		



## Playback

<b>Basic operation</b>	<b>53</b>
Turning the power on	53
Selecting the input source	53
Adjusting the volume	54
Turning off the sound temporarily (Muting)	54
Playback a Blu-ray Disc player/DVD player	54
<b>Playing a USB memory device</b>	<b>55</b>
Playing files stored on USB memory devices	56
<b>Listening to music on a Bluetooth device</b>	<b>59</b>
Playing music from Bluetooth device	60
Pairing with other Bluetooth devices	61
Reconnecting to this unit from a Bluetooth device	62
<b>Listening to audio on Bluetooth headphones</b>	<b>63</b>
Listening to audio on Bluetooth headphones	64
Adjusting the volume of Bluetooth headphones	65
Reconnecting to a Bluetooth headphones	65
Disconnecting Bluetooth headphones	66

<b>Listening to FM/AM broadcasts</b>	<b>67</b>
Listening to FM/AM broadcasts	68
Tuning in by entering the frequency (Direct Tune)	69
Changing the tune mode (Tune Mode)	70
Tuning in to stations and presetting them automatically (Auto Preset Memory)	70
Presetting the current broadcast station (Preset Memory)	71
Listening to preset stations	71
Specify a name for the preset broadcast station (Preset Name)	72
Skipping preset broadcast stations (Preset Skip)	73
Cancelling Preset Skip	74
<b>Listening to Internet Radio</b>	<b>75</b>
Listening to Internet Radio	76
<b>Playing back files stored on a PC or NAS</b>	<b>77</b>
Playing back files stored on a PC or NAS	78
<b>Getting the HEOS App</b>	<b>81</b>
HEOS Account	82
Playing from streaming music services	83
Listening to the same music in multiple rooms	86



<b>AirPlay function</b>	<b>90</b>	<b>Selecting a sound mode</b>	<b>102</b>
Playing songs from your iPhone, iPod touch or iPad	91	Selecting a sound mode	102
Playing iTunes music with this unit	91	Description of sound mode types	103
Play a song from your iPhone, iPod touch or iPad on multiple synced devices (AirPlay 2)	92	<b>HDMI Control function</b>	<b>104</b>
<b>Spotify Connect function</b>	<b>93</b>	Setting procedure	104
Playing Spotify music with this unit	93	<b>Sleep timer function</b>	<b>105</b>
<b>Convenience functions</b>	<b>94</b>	Using the sleep timer	106
Playing back HEOS Favorites	95	<b>Smart select function</b>	<b>107</b>
Adding to HEOS Favorites	96	Calling up the settings	108
Deleting a HEOS Favorites	96	Changing the settings	109
Adjust the sound output balance of left and right speakers (Balance)	96	<b>Panel lock function</b>	<b>111</b>
Adjust the subwoofer output (Subwoofer)	97	Disabling all knob operations	111
Adjusting the tone (Tone)	98	Disabling all knob operations except VOLUME	112
Adjusting audio delay (Audio Delay)	99	Canceling the Panel lock function	112
Displaying your desired video during audio playback (Video Select)	100	<b>Remote lock function</b>	<b>113</b>
Playing the same music in all zones (All Zone Stereo)	101	Disabling the sensor function of the remote control unit	113
		Enabling the remote sensor function	114
		<b>Web control function</b>	<b>115</b>
		Controlling the unit from a web control	115
		<b>Playback in ZONE2 (Another room)</b>	<b>117</b>
		Connecting ZONE2	118
		Playback the source in ZONE2	119
		Adjusting the Volume in ZONE2	122



## Settings

<b>Menu map</b>	<b>123</b>
Menu operations	128
<b>Audio</b>	<b>129</b>
M-DAX	129
Volume	130
<b>Video</b>	<b>131</b>
HDMI Setup	131
HDMI Upscaler	135
On-Screen Display	136
Screensaver	137
4K/8K Signal Format	137
HDCP Setup	139
<b>Inputs</b>	<b>140</b>
Input Assign	140
Source Rename	143
Hide Sources	143
Source Level	143
<b>Speakers</b>	<b>144</b>
Speaker Layout	144
Distances	145
Levels	146
Advanced	146

<b>Network</b>	<b>147</b>
Information	147
Connection	147
Wi-Fi Setup	148
Settings	149
Network Control	151
Friendly Name	151
Diagnostics	152
AirPlay	153
Spotify Connect	153
Wi-Fi and Bluetooth	154
<b>HEOS</b>	<b>155</b>
You have not signed in	155
You have already signed in	155



<b>General</b>	<b>156</b>
Language	156
Owner's Manual	156
ECO	156
Bluetooth Transmitter	160
ZONE2 Setup	161
Zone Rename	162
Smart Select	162
Front Display	163
Firmware	164
Information	166
Usage Data	169
Save & Load	169
Setup Lock	170
Reset	170
<b>Operating CD player with the remote control unit</b>	<b>171</b>
<b>Limiting the operating zone with the remote control</b>	<b>172</b>
<b>Setting the back light of the remote control unit</b>	<b>173</b>
Disabling the backlight	173

## Tips

<b>Tips</b>	<b>175</b>
<b>Troubleshooting</b>	<b>176</b>
Power does not turn on / Power is turned off	177
Operations cannot be performed through the remote control unit	178
Display on this unit shows nothing	178
No sound comes out	179
Desired sound does not come out	180
Sound is interrupted or noise occurs	182
No video is shown on the TV	183
The menu screen is not displayed on the TV	184
The color of the menu screen and operations content displayed on the television is different from normal	184
AirPlay cannot be played back	185
USB memory devices cannot be played back	186
Bluetooth cannot be played back	187
The Internet radio cannot be played back	189
Music files on PC or NAS cannot be played back	190
Various online services cannot be played	191
The HDMI Control function does not work	191
Cannot connect to a wireless LAN network	192
Update error messages	193
<b>Resetting factory settings</b>	<b>194</b>
<b>Resetting network settings</b>	<b>195</b>
<b>Factory Restore</b>	<b>196</b>



## Appendix

<b>About HDMI</b>	<b>197</b>
<b>Relationship between video signals and TV output</b>	<b>200</b>
<b>Playing back a USB memory devices</b>	<b>202</b>
<b>Playing back a Bluetooth device</b>	<b>203</b>
<b>Playing back a file saved on a PC or NAS</b>	<b>204</b>
<b>Playing back Internet Radio</b>	<b>205</b>
<b>Personal memory plus function</b>	<b>205</b>
<b>Last function memory</b>	<b>205</b>
<b>Explanation of terms</b>	<b>206</b>
<b>Trademark information</b>	<b>210</b>
<b>Specifications</b>	<b>212</b>
Audio section	212
Tuner section	213
Wireless LAN section	213
Bluetooth section	214
General	215
<b>Index</b>	<b>217</b>







Thank you for purchasing this Marantz product.

To ensure proper operation, please read this owner's manual carefully before using the product.

After reading this manual, be sure to keep it for future reference.

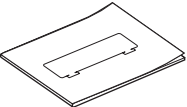
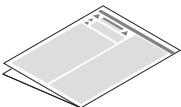
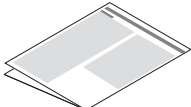
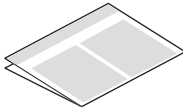
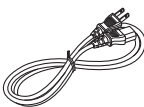
## Accessories

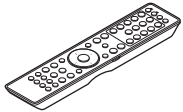
Check that the following parts are supplied with the product.

 <p>Quick Start Guide</p>	 <p>Safety Instructions</p>	 <p>Notes on radio</p>	 <p>Warranty (for North America model only)</p>	 <p>Power cord</p>
 <p>FM indoor antenna</p>	 <p>AM loop antenna</p>	 <p>Remote control unit (RC052SR)</p>	 <p>2x R03/AAA batteries</p>	 <p>External antennas for Bluetooth/wireless connectivity</p>





## Inserting the batteries

- 1 Remove the rear lid in the direction of the arrow and remove it.

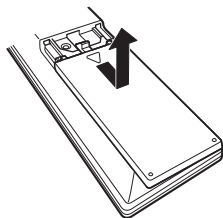

- 2 Insert two batteries correctly into the battery compartment as indicated.

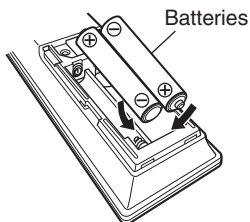

- 3 Put the rear cover back on.

### NOTE

- To prevent damage or leakage of battery fluid:
  - Do not use a new battery together with an old one.
  - Do not use two different types of batteries.
- Remove the batteries from the remote control unit if it will not be in use for long periods.
- If the battery fluid should leak, carefully wipe the fluid off the inside of the battery compartment and insert new batteries.

## Operating range of the remote control unit

Point the remote control unit at the remote sensor when operating it.

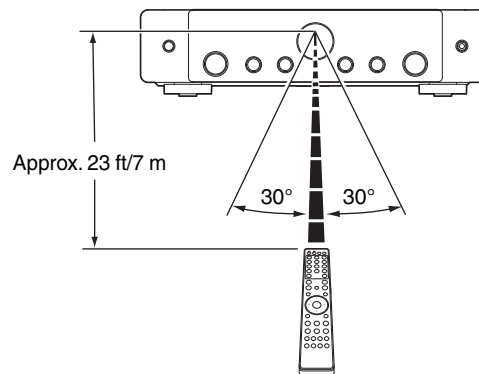

# Features

## High quality sound

- **High-power amplifier (100 Watts x 2-channels)**

The power amplifier circuit is made with a power transformer and power supply capacitors designed for stereo receivers and uses a discrete part structure, achieving powerful, high-quality sound reproduction.

- **Double-differential D/A converter circuit**

A double-differential circuit is used to reduce noise, achieving clearer audio playback.

## High performance

- **8K 60Hz input/output supported**

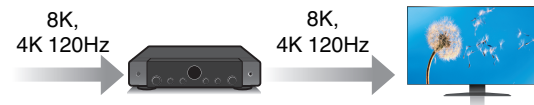

When 8K Ultra HD (High Definition) is used, an input/output speed of 60 frames per second (60p) is achieved for video signals. When connected to 8K Ultra HD and 60p video signal input compatible TV, you can enjoy the sense of realism only available from high-definition images, even when viewing fast-moving video.

This unit supports a wide range of HDR content, delivering even higher definition video.

- **HDCP 2.3**

This unit is compatible with HDCP 2.3 copyright protection standard.



- Digital video processor upscales 1080p / 4K to 8K



This unit is equipped with a 8K video upscaling function that allows 1080p/4K video to be output via HDMI at 8K (7680 × 4320 pixels) resolution. This function enables the device to be connected to a TV using a single HDMI cable, and produces high definition images for any video source.

- HDMI connections enable connection to various digital AV devices (6 inputs, 1 output)

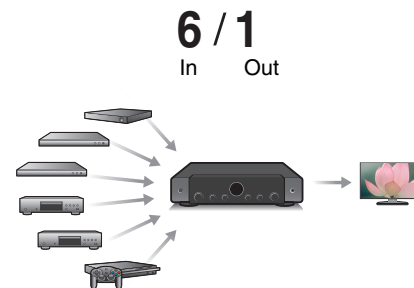

This unit is equipped with 6 HDMI inputs and 1 HDMI output enabling connection to various HDMI compatible devices such as Blu-ray Disc players, game consoles and HD video camcorders.

- The device is equipped with a **AirPlay®** function in addition to network functions such as Internet radio etc. (☞ p. 90)

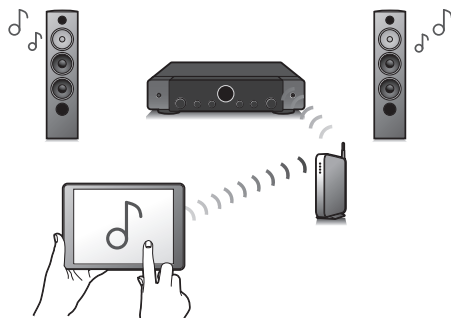

You can enjoy a wide variety of content, including listening to Internet Radio, playing audio files stored on your PC.

This unit also supports Apple AirPlay which lets you stream your music library from an iPhone®, iPad®, iPod touch® or iTunes®.

- **Supports AirPlay 2® wireless audio**

Sync multiple AirPlay 2 compatible devices/speakers for simultaneous playback.

This unit supports AirPlay 2 and requires iOS 11.4 or later.

- **Playback of DSD and FLAC files via USB and networks**

This unit supports the playback of high resolution audio formats such as DSD (5.6 MHz) and FLAC 192 kHz files. It provides high quality playback of high resolution files.

- **Wireless connection with Bluetooth devices can be carried out easily** (☞ p. 59)

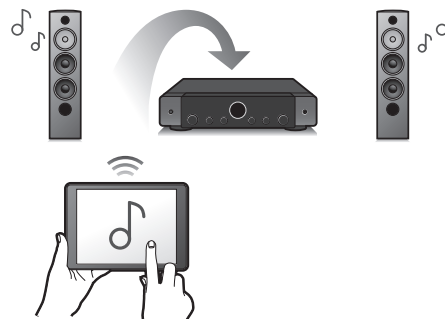

You can enjoy music simply by connecting wirelessly with your smartphone, tablet, PC, etc.

- **Connect Bluetooth headphones**

This unit can transmit Bluetooth so you can enjoy audio wirelessly through your Bluetooth headphones.

Playback can be performed using connected speakers and Bluetooth headphones simultaneously, or only using Bluetooth headphones.

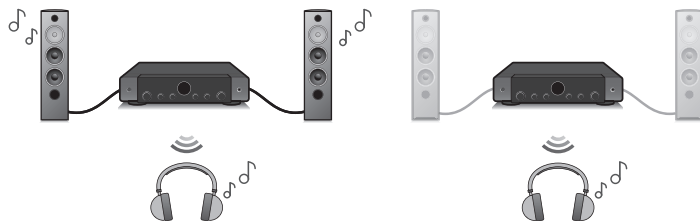

- **Multi-Room audio (🔑 p. 101)**

[MAIN ZONE]

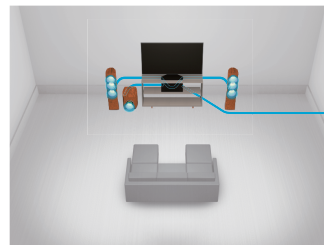

[ZONE2]

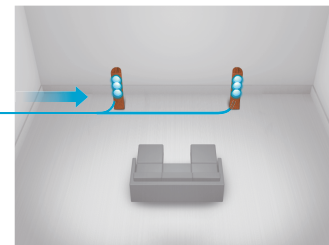

You can select and play back the respective inputs in MAIN ZONE and ZONE2.

In addition, when the All Zone Stereo function is used, the music being played back in MAIN ZONE can be enjoyed in all the zones at the same time. This is useful when you want to let the BGM propagate throughout the whole house.

- **Energy-saving design**

This unit is equipped with an ECO Mode function that allows you to enjoy music and movies while reducing the power consumption during use, and also an auto-standby function that automatically turns off the power supply when the unit is not in use. This helps reduce unnecessary power use.



- Compatible with the “Marantz AVR Remote” App\* for performing basic operations of the unit with an iPad, iPhone or Android™ devices (Google, Amazon Kindle Fire)



The Marantz AVR Remote app gives you full control of this unit as well as access to its setup menu for detailed adjustments from your phones or tablets. “Marantz AVR Remote” App also gives you quick access to the receiver’s status display, option menus, Marantz Blu-ray Disc player control, and online owner’s manual for your convenience.

\* Download the appropriate “Marantz AVR Remote” App for your iOS or Android devices. This unit needs to be connected to the same LAN or Wi-Fi (wireless LAN) network that the iPad, iPhone or Android™ is connected to.

- HEOS provides streaming music from your favorite online music sources

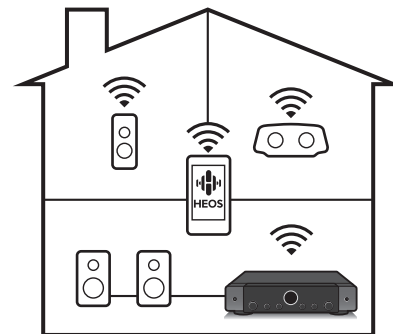

HEOS wireless multi-room sound system that enables you to enjoy your favorite music anywhere and everywhere around your home. By utilizing your existing home network and the HEOS App (available for iOS, Android and Amazon devices), you can explore, browse, and play music from your own music library or from many online streaming music services.

When multiple products with HEOS Built-in are connected to the same network, they can be grouped to play the same music on all products simultaneously, or different music can be played on each one.



## Easy operation

- **“Setup Assistant” provides easy-to-follow setup instructions**

First select the language when prompted. Then simply follow the instructions displayed on the TV screen to set up the speakers, network, etc.

- **Easy to use Graphical User Interface**

This unit is equipped with a Graphical User Interface for improved operability.



## Part names and functions

### Front panel

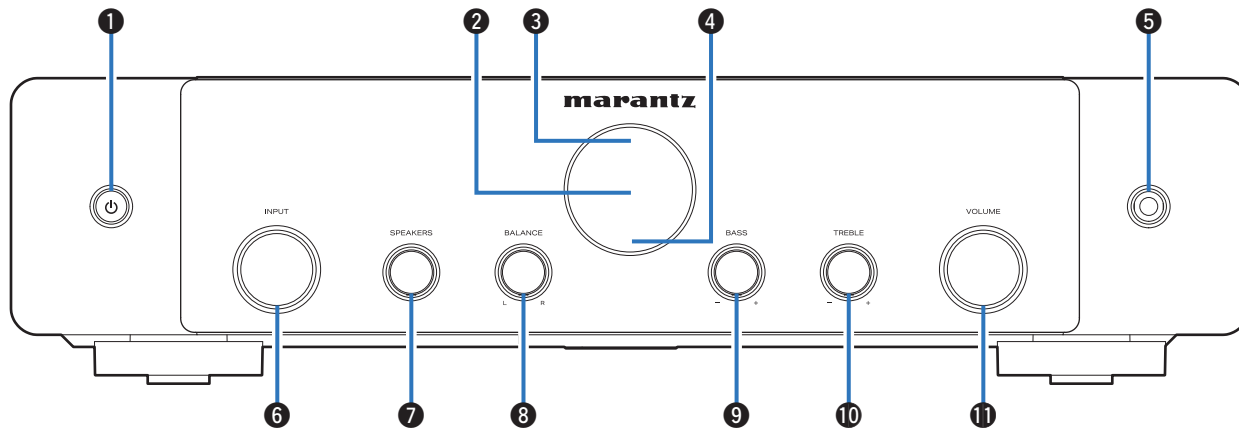

For details, see the next page.





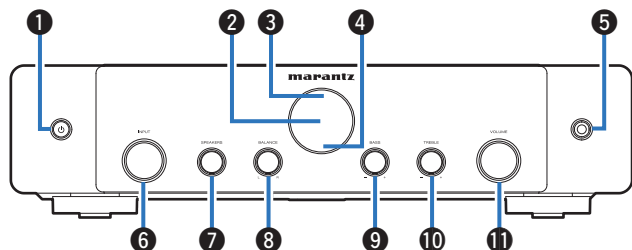

### 1 Power operation button (⏻)

Used to turn the power of the MAIN ZONE (room where this unit is located) on/off (standby). (👉 p. 53)

### 2 Display

This displays various pieces of information. (👉 p. 18)

### 3 Remote control sensor

This receives signals from the remote control unit. (👉 p. 9)

### 4 Protection circuit indicator

This blinks when the protection circuit has operated. (👉 p. 177)

### 5 Headphones jack (PHONES)

This is used to connect headphones.

When the headphones are plugged into this jack, audio will no longer be output from the connected speakers or from the SUBWOOFER connectors.

#### NOTE

- To prevent hearing loss, do not raise the volume level excessively when using headphones.

### 6 INPUT selector knob

This selects the input source. (👉 p. 53)

### 7 Speaker switching knob (SPEAKERS)

This selects the speaker for audio output.

### 8 Balance knob (BALANCE)

This adjusts the balance of the volume output from the left and right speakers.

### 9 Bass control knob (BASS)

This setting adjusts the volume level for the bass.

### 10 Treble control knob (TREBLE)

This setting adjusts the volume level for the treble.

### 11 VOLUME knob

This adjusts the volume level. (👉 p. 54)



## Display

The input source name, sound mode, setting values and other information are displayed here.

### ▣ Standard display

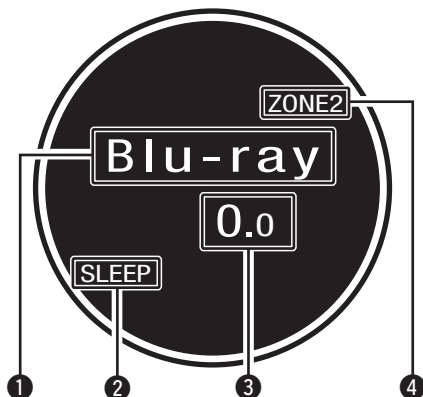

#### ❶ Input source indicator

The currently selected input source name is displayed.

If the input source name has been changed using “Source Rename” in the menu, the input source name after the change is displayed.

(👉 p. 143)

#### ❷ Sleep timer indicator

This lights when the sleep mode is selected. (👉 p. 105)

#### ❸ Volume indicator

#### ❹ ZONE2 power on display

Lights up when ZONE2 power is turned on.



## ❑ Tuner display

These light up according to the reception conditions when the input source is set to “Tuner”.

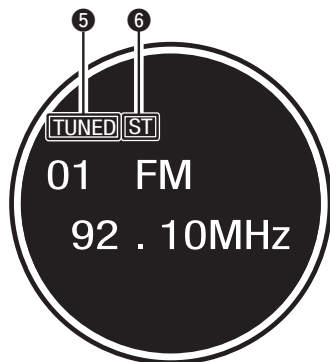

- 5 Lights up when the broadcast is properly tuned in.
- 6 Lights up when receiving FM stereo broadcasts.



## Rear panel

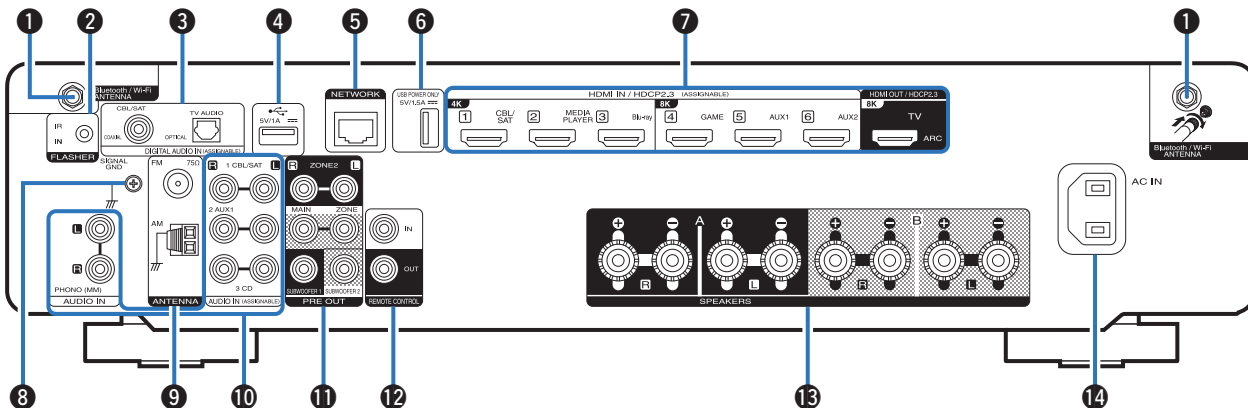

For details, see the next page.



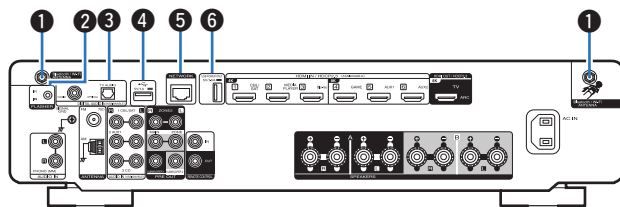

### 1 Bluetooth/wireless LAN antenna connectors

Used to connect the included external antennas for Bluetooth/wireless connectivity when connecting to a network via wireless LAN, or when connecting to a handheld device via Bluetooth. (☞ p. 47)

- ① Place the external antennas for Bluetooth/wireless connectivity evenly over the rear terminal of rear.
- ② Turn clockwise until the antennas is fully connected.
- ③ Rotate the antenna upwards for best reception.

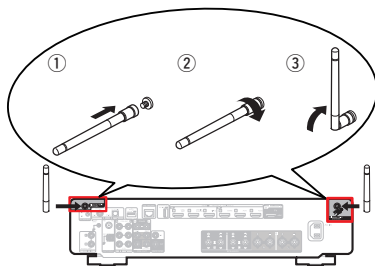

### 2 FLASHER IN jack

Used when using a control BOX or other such control devices to control this unit.

### 3 Digital audio connectors (DIGITAL AUDIO)

Used to connect devices equipped with digital audio connectors.

- “Connection 2 : TV equipped with an HDMI connector and incompatible with the ARC (Audio Return Channel)” (☞ p. 36)
- “Connecting a set-top box (Satellite tuner/cable TV)” (☞ p. 38)

### 4 USB port (☞)

This is used to connect USB storages (such as USB memory devices). (☞ p. 43)

### 5 NETWORK connector

Used to connect to a LAN cable when connecting to a wired LAN network. (☞ p. 46)

### 6 USB port (POWER SUPPLY)

Can be used to power streaming media players, etc.



- Use a device’s supplied AC adapter when a power supply of 5 V/1.5 A or more is required.
- To play content from a USB memory device, connect to the USB port 4.



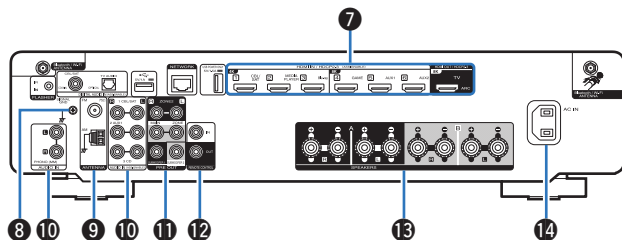

### 7 HDMI connectors

Used to connect devices equipped with HDMI connectors.

- “Connection 1 : TV equipped with an HDMI connector and compatible with the ARC (Audio Return Channel)” (☞ p. 35)
- “Connection 2 : TV equipped with an HDMI connector and incompatible with the ARC (Audio Return Channel)” (☞ p. 36)
- “Connecting a set-top box (Satellite tuner/cable TV)” (☞ p. 38)
- “Connecting a media player” (☞ p. 39)
- “Connecting a Blu-ray Disc player or DVD player” (☞ p. 40)
- “Connecting a game console or player device compatible with 8K” (☞ p. 41)

### 8 SIGNAL GND terminal

Used to connect a ground wire for the turntable. (☞ p. 42)

### 9 FM/AM antenna terminals (ANTENNA)

Used to connect FM antennas and AM loop antennas. (☞ p. 44)

### 10 Analog audio connectors (AUDIO)

Used to connect devices equipped with analog audio connectors.

- “Connecting a set-top box (Satellite tuner/cable TV)” (☞ p. 38)
- “Connecting a turntable” (☞ p. 42)

### 11 PRE OUT connectors

Used to connect a subwoofer with built-in amplifier or power amplifier.

- “Connecting the subwoofer” (☞ p. 29)
- “Connecting speakers that uses a power amplifier” (☞ p. 33)
- “Connecting ZONE2” (☞ p. 118)

### 12 REMOTE CONTROL jacks

Used to connect infrared receivers/transmitters in order to operate this unit and external devices from a different room. (☞ p. 48)

### 13 Speaker terminals (SPEAKERS)

Used to connect speakers.

- “Connecting 2.1-channel speakers” (☞ p. 30)
- “Second pair of speaker” (☞ p. 31)
- “Bi-wiring connection” (☞ p. 32)

### 14 AC inlet (AC IN)

Used to connect the power cord. (☞ p. 51)

#### NOTE

- Do not touch the inner pins of the connectors on the rear panel. Electrostatic discharge may cause permanent damage to the unit.



## Remote control unit

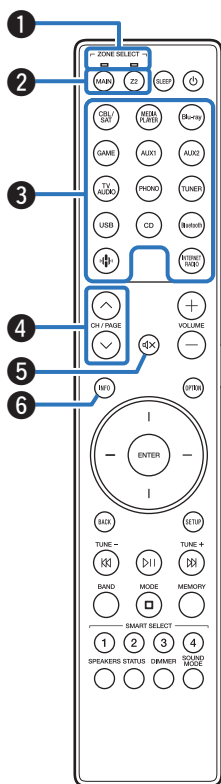

### 1 Zone mode indicators

The indicator of the zone that you are operating lights up.

### 2 ZONE SELECT buttons (MAIN, Z2)

These switch the zone (MAIN ZONE, ZONE2) that is operated through the remote control unit.

- “Playing different sources in MAIN ZONE and ZONE2” (👉 p. 121)
- “Menu operations” (👉 p. 128)
- “Limiting the operating zone with the remote control” (👉 p. 172)

### 3 Input source select buttons

These selects the input source.

- “Selecting the input source” (👉 p. 53)
- “Playing different sources in MAIN ZONE and ZONE2” (👉 p. 121)

### 4 Channel/page search buttons (CH/PAGE ^ v)

These select radio stations registered to presets or switch pages. (👉 p. 71)

### 5 MUTE button (🔇)

This mutes the output audio.

- “Turning off the sound temporarily (Muting)” (👉 p. 54)
- “Turning off the sound temporarily (Muting)” (👉 p. 122)

### 6 Information button (i)

This displays the status information on the TV screen. (👉 p. 168)

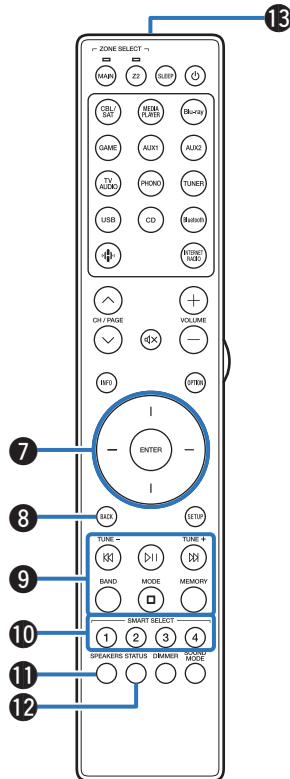

**7 Cursor buttons**

These select items.

**8 BACK button**

This returns to the previous screen.

**9 System buttons**

These perform playback related operations.

**Tuning up / Tuning down buttons (TUNE +, -)**

These select either FM broadcast or AM broadcast. (☞ p. 68)

**Reception band select button (BAND)**

This switches the reception band. (☞ p. 68)

**Tune mode select button (MODE)**

This switches the tuning mode. (☞ p. 70)

**Preset memory button (MEMORY)**

The current broadcast station that is preset. (☞ p. 71)

**10 SMART SELECT buttons (1 - 4)**

These call up settings registered to each button, such as input source, volume level and sound mode settings. (☞ p. 107)

**11 Speaker switching button (SPEAKERS)**

This selects the speaker for audio output.

**12 STATUS button**

Each press of this switches the status information that is shown on the display.

**13 Remote control signal transmitter**

This transmits signals from the remote control unit. (☞ p. 9)





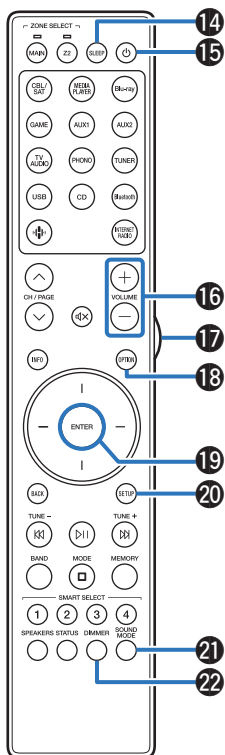

#### 14 SLEEP button

This sets the sleep timer. (👉 p. 105)

#### 15 POWER button (⏻)

This turns the power on/off.

- “Turning the power on” (👉 p. 53)
- “Playing different sources in MAIN ZONE and ZONE2” (👉 p. 121)

#### 16 VOLUME buttons (+/-)

These adjust the volume level.

- “Adjusting the volume” (👉 p. 54)
- “Adjusting the Volume in ZONE2” (👉 p. 122)

#### 17 Light button

This turns on the backlight for approx. 5 seconds. (👉 p. 173)

#### 18 OPTION button

This displays the option menu on the TV screen.

#### 19 ENTER button

This determines the selection.

#### 20 SETUP button

This displays the menu on the TV screen. (👉 p. 128)

#### 21 SOUND MODE button

These select the sound mode. (👉 p. 102)

#### 22 DIMMER button

Each press of this switches the brightness of the display. (👉 p. 163)



## ■ Contents







Speaker installation	27
Connecting speakers	28
Connecting a TV	34
Connecting a playback device	37
Connecting a USB memory device to the USB port	43
Connecting FM/AM antennas	44
Connecting to a home network (LAN)	46
Connecting an external control device	48
Connecting the power cord	51

### NOTE

- Do not plug in the power cord until all connections have been completed. However, when the "Setup Assistant" is running, follow the instructions in the "Setup Assistant" (page 8 in the separate "Quick Start Guide") screen for making connections. (During "Setup Assistant" operation, the input/output connectors do not conduct current.)
- Do not bundle power cords together with connection cables. Doing so can result in noise.

## ■ Cables used for connections

Provide necessary cables according to the devices you want to connect.

Speaker cable	
Subwoofer cable	
HDMI cable	
Coaxial digital cable	
Optical cable	
Audio cable	
LAN cable	



## Speaker installation

Determine the speaker system depending on the number of speakers you are using and install each speaker and subwoofer in the room. Speaker installation is explained using this example of a typical installation.

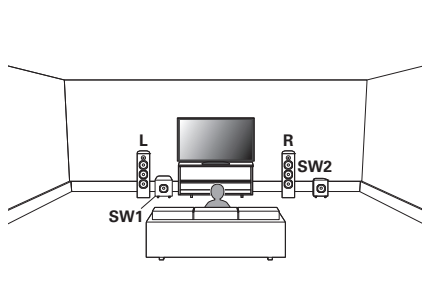

**L/R**  
(LEFT/RIGHT  
speaker):

Place the LEFT and RIGHT speakers an equal distance from the main listening position. The distance between each speaker and your TV should also be the same.

**SW 1/2**  
(Subwoofer):

Place the SUBWOOFER at a convenient location near the speakers. If you have two subwoofers, place them asymmetrically across the front of your room.



# Connecting speakers

Here we connect the speakers in the room to this unit.

## Before connecting speakers

### NOTE

- Disconnect this unit's power plug from the power outlet before connecting the speakers. Also, turn off the subwoofer.
- Connect so that the speaker cable core wires do not protrude from the speaker terminal. The protection circuit may be activated if the core wires touch the rear panel or if the + and - sides touch each other. ("Protection circuit" (🔧 p. 209))
- Never touch the speaker terminals while the power cord is connected. Doing so could result in electric shock. When the "Setup Assistant" (page 8 in the separate "Quick Start Guide") is running, follow the instructions in the "Setup Assistant" screen for making connections. (Power is not supplied to the speaker terminals while the "Setup Assistant" is running.)
- Use speakers with an impedance of 4 – 16 Ω/ohms.

### NOTE

- Carry out the following settings when using a speaker with an impedance of 4 – 6 Ω/ohms.
  1. When this unit is turned on, press and hold  $\phi$  on the main unit until "SPECIAL MODE" appears on the display.
  2. Turn the INPUT selector knob on the main unit to select "5Special Settings", then press  $\phi$ .  
"4K/8K Format <Enh>" appears on the display.
  3. Turn the INPUT selector knob on the main unit to select "Sp.Imp. <8ohms>".
  4. Turn the SPEAKERS switching knob on the main unit to select impedance.

<b>8ohms</b> (Default):	Select when the impedance for all of the connected speakers is 8 Ω/ohms or over.
----------------------------	--

<b>6ohms:</b>	Select when the impedance for any of the connected speakers is 6 Ω/ohms.
---------------	--

<b>4ohms:</b>	Select when the impedance for any of the connected speakers is 4 Ω/ohms.
---------------	--

5. Press  $\phi$  on the main unit to confirm the settings.



## ■ Connecting the speaker cables

Carefully check the left (L) and right (R) channels and + (red) and – (black) polarities on the speakers being connected to this unit, and be sure to connect the channels and polarities correctly.

- 1 Peel off about 3/8 inch (10 mm) of sheathing from the tip of the speaker cable, then either twist the core wire tightly or terminate it.



- 2 Turn the speaker terminal counterclockwise to loosen it.



- 3 Insert the speaker cable's core wire to the hilt into the speaker terminal.

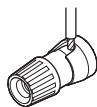

- 4 Turn the speaker terminal clockwise to tighten it.

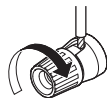

## ■ Connecting the subwoofer

Use a subwoofer cable to connect the subwoofer. Two subwoofers can be connected to this unit.

The same signal is output from the respective subwoofer terminals.

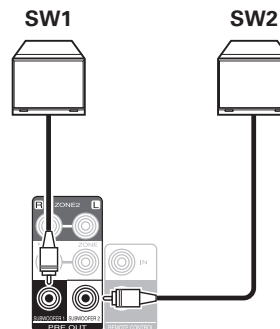

## Connecting 2.1-channel speakers

This serves as a basic 2.1-channel surround system.

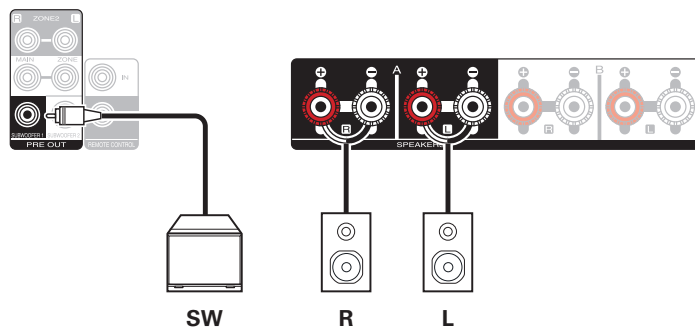
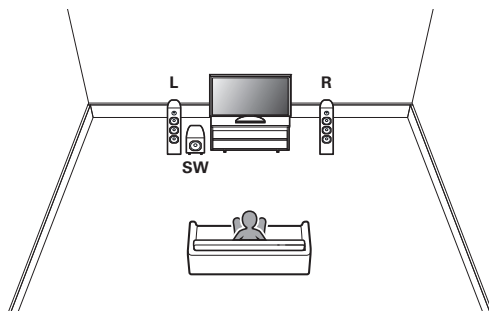

## Second pair of speaker

This system enables switching playback between speakers A and B as desired.

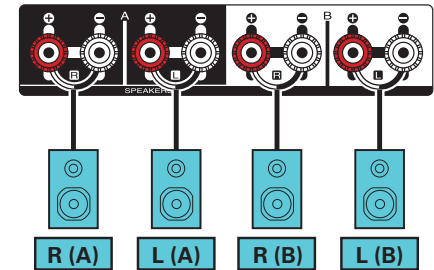
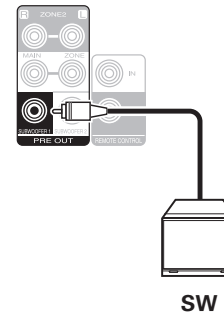
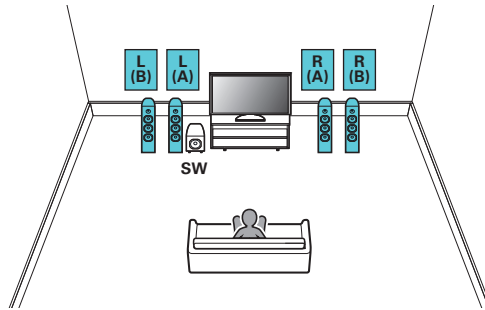

### CAUTION:

- Set speaker impedance to “4ohms” before performing simultaneous playback from speakers A and B. (👉 p. 28)



## Bi-wiring connection

This connection limits the effects of signal interference between the high range speakers (tweeters) and low range speakers (woofers), allowing you to enjoy high quality playback.

When bi-wiring with bi-wireable speakers, connect the mid and high range terminals to SPEAKERS A (or B), the low range terminals to SPEAKERS B (or A).

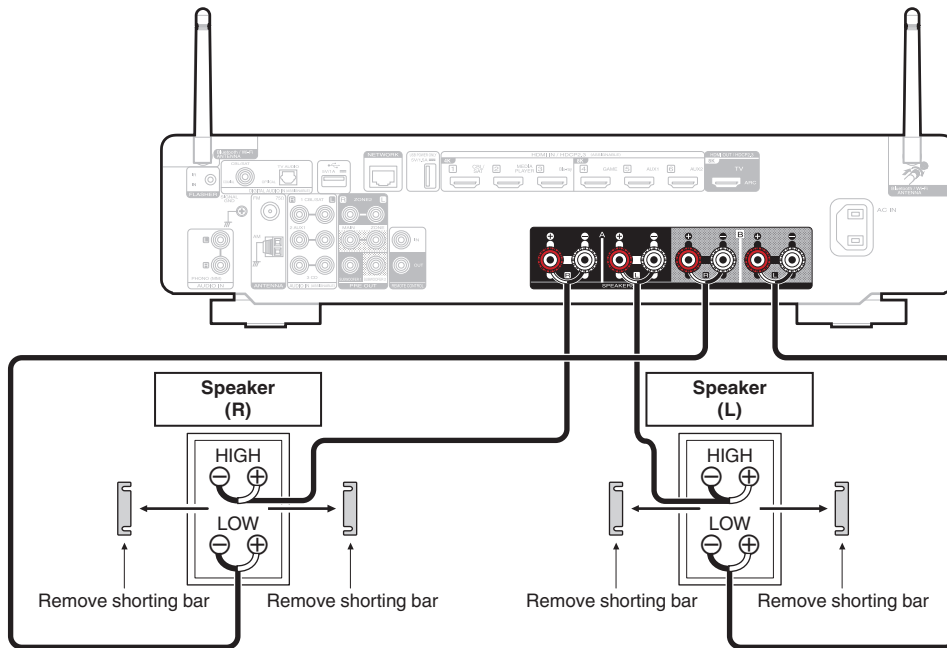

- When using bi-wiring connections, set the speaker to "A+B" to output audio from both SPEAKERS A and SPEAKERS B speaker terminals. (p. 146)





## ■ Connecting speakers that uses a power amplifier

This unit supports connection of speakers that uses an external power amplifier to increase its output. Connect a separately sold power amplifier to the PRE OUT (MAIN ZONE) connector of this unit.

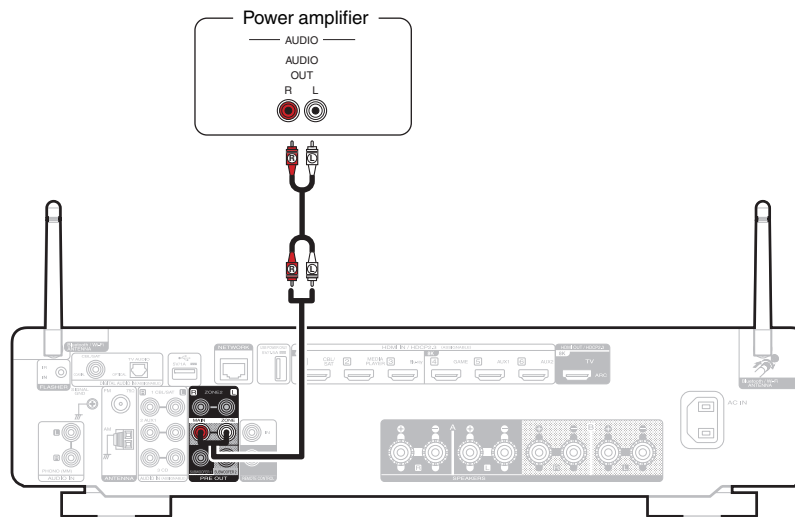

## Connecting a TV

Connect a TV to this unit so that the input video is output to the TV. You can also enjoy audio from the TV on this unit.

How to connect a TV depends on the connectors and functions equipped on the TV.

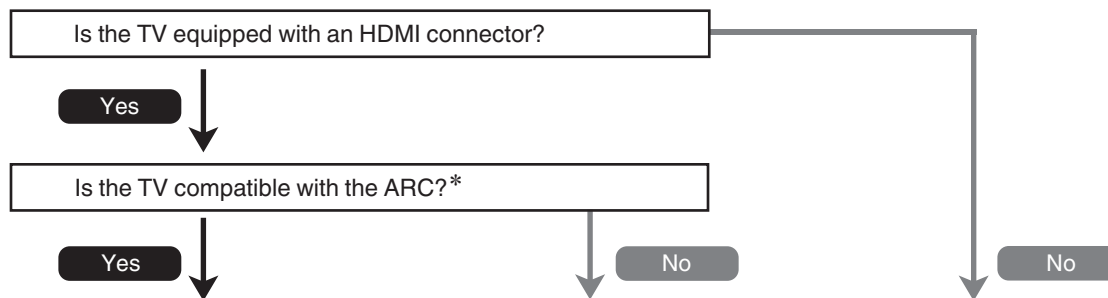

**“Connection 1 : TV equipped with an HDMI connector and compatible with the ARC (Audio Return Channel)”** (📖 p. 35)

**“Connection 2 : TV equipped with an HDMI connector and incompatible with the ARC (Audio Return Channel)”** (📖 p. 36)

**You cannot connect the TV to this unit.**

### \* What is ARC?

ARC (Audio Return Channel) sends audio back to this unit using the same HDMI cable that sends video from this unit to your TV. This allows this unit to process the sound from your TV's built-in tuner and apps.

### NOTE

- Use a TV with a 2 prong power plug for this unit. Do not connect a TV with a 3 prong power plug, as this may cause noise.



## Connection 1 : TV equipped with an HDMI connector and compatible with the ARC (Audio Return Channel)

Using a high quality HDMI cable\*, connect one end to the HDMI port labeled “ARC” on your TV. Connect the other end to the HDMI OUT 1 port on this unit.

When a TV with ARC support is connected, set “ARC” in the menu to “On”. (🔗 p. 133)

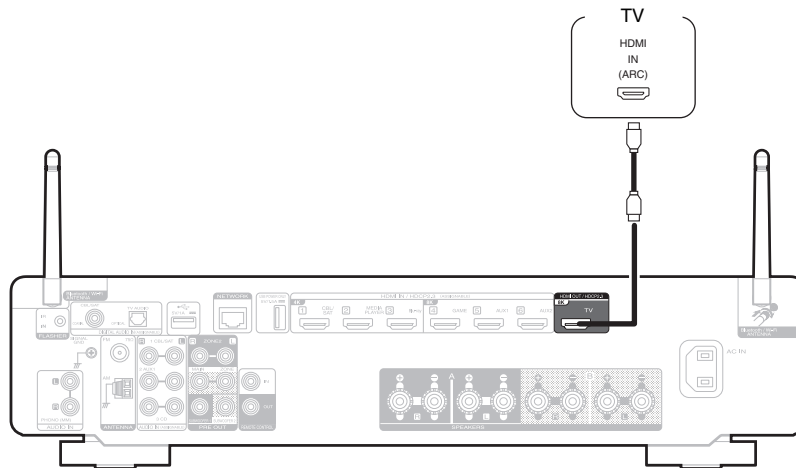

\* For 4K TVs we recommend using an HDMI cable labeled “High Speed” and “with Ethernet”.

\* For 8K TVs we recommend using an HDMI cable labeled “Ultra High Speed”.



- Only the PCM 2-channel setting can be used to play sound from a TV via the ARC function. Set “PCM 2ch” as the audio format in the TV settings.
- Set “4K/8K Signal Format” to “8K Enhanced” in the menu to enjoy 8K video. (🔗 p. 137)



## Connection 2 : TV equipped with an HDMI connector and incompatible with the ARC (Audio Return Channel)

Use an HDMI cable to connect the TV to this unit.

To listen to audio from TV on this unit, use an optical cable to connect the TV to this unit.

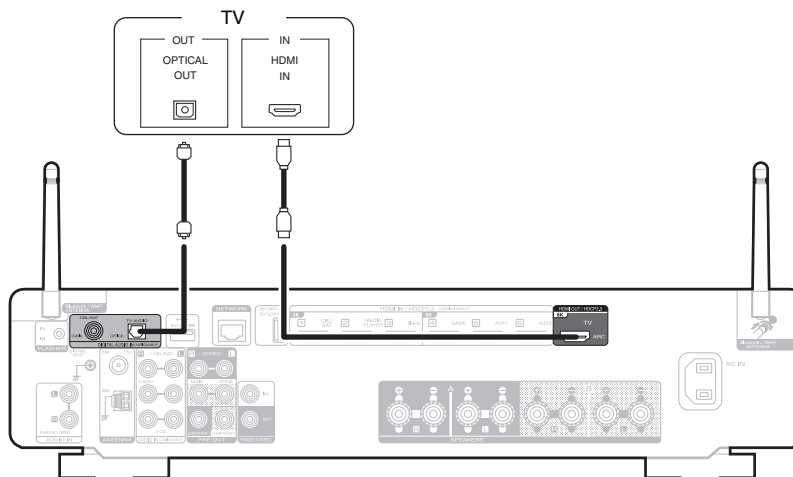

- Only the PCM 2-channel setting can be used to play sound from a TV via a digital signal. Set "PCM 2ch" as the audio format in the TV settings.



## Connecting a playback device

This unit is equipped with one type of video input connectors (HDMI) and three types of audio input connectors (HDMI, digital audio and audio).

Select input connectors on this unit according to the connectors equipped on the device you want to connect.

If the device connected to this unit is equipped with an HDMI connector, it is recommended to use HDMI connections.

In the HDMI connection, audio and video signals can be transmitted through a single HDMI cable.

- “Connecting a set-top box (Satellite tuner/cable TV)” (🔍 p. 38)
- “Connecting a media player” (🔍 p. 39)
- “Connecting a Blu-ray Disc player or DVD player” (🔍 p. 40)
- “Connecting a game console or player device compatible with 8K” (🔍 p. 41)
- “Connecting a turntable” (🔍 p. 42)



- Connect devices to this unit as indicated by the input sources printed on the audio/video input connectors of this unit.
- The source that is assigned to the HDMI IN, DIGITAL AUDIO IN and AUDIO IN connectors can be changed. See “Input Assign” on how to change the input source assigned to the input connectors. (🔍 p. 140)
- To play back audio signals that are input to this unit on a TV connected via HDMI, set in the menu “HDMI Audio Out” to “TV”. (🔍 p. 131)
- To enjoy content that is copyright protected by HDCP 2.2 or HDCP 2.3, use a playback device and TV compatible with HDCP 2.2 or HDCP 2.3.
- This unit supports analog audio signals and PCM 2-channel signals. To play sources such as Dolby Digital discs, set “PCM 2ch” as the audio format in the audio device settings.



## Connecting a set-top box (Satellite tuner/cable TV)

This explanation uses the connection with a satellite tuner/cable TV STB as an example.

Select the input connectors on this unit to match the connectors on the device that you want to connect to.

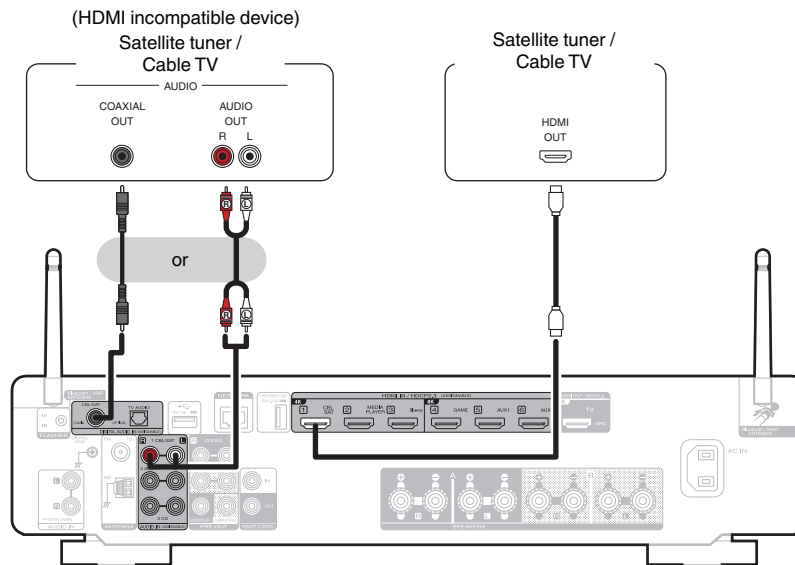

## Connecting a media player

This explanation uses the connection with a media player as an example.

Select the input connectors on this unit to match the connectors on the device that you want to connect to.

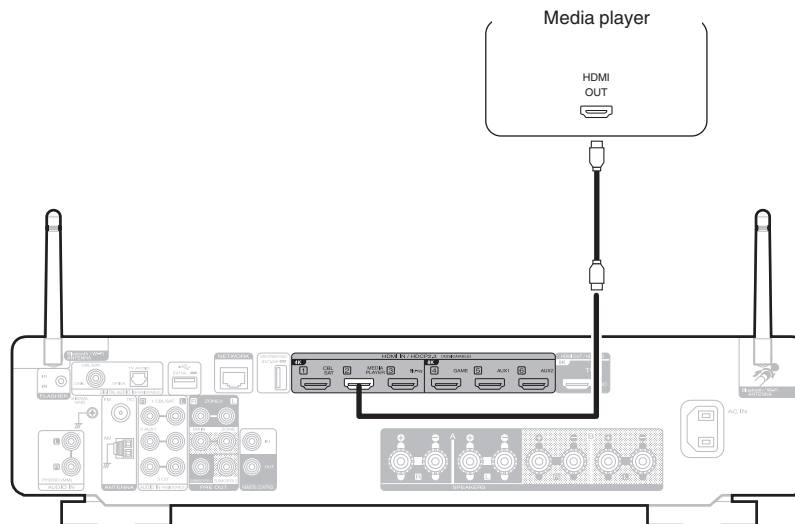

## Connecting a Blu-ray Disc player or DVD player

This explanation uses the connection with a Blu-ray Disc player or DVD player as an example.

Select the input connectors on this unit to match the connectors on the device that you want to connect to.

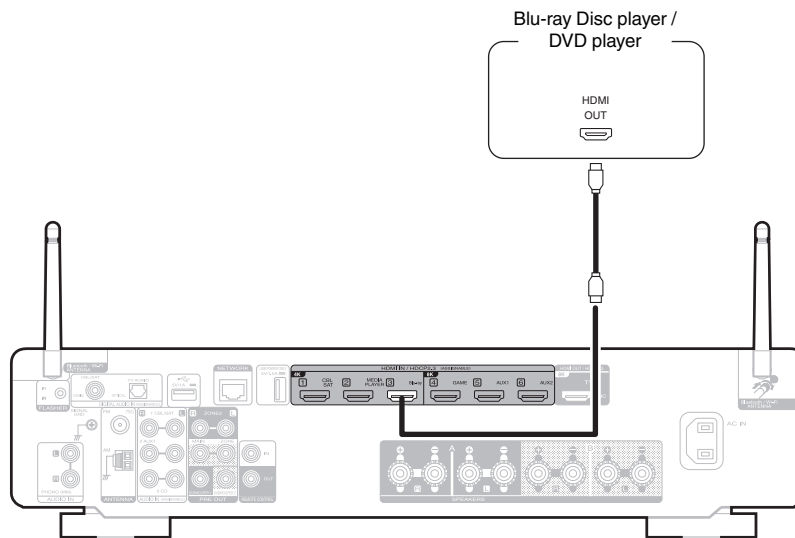



## Connecting a game console or player device compatible with 8K

This unit supports 8K HDMI video signals.

If your game console or player device supports 8K, connect it to the HDMI 4, HDMI 5 or HDMI 6 connector on your device.

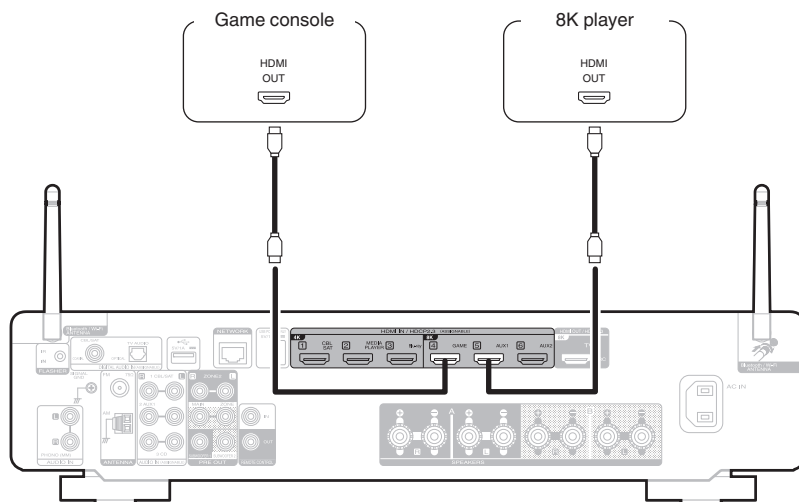

- Use a certified "Ultra High Speed HDMI cable" to enjoy 8K or 4K 120Hz video.
- Set "4K/8K Signal Format" to "8K Enhanced" in the menu to enjoy 8K video. (🔧 p. 137)



## Connecting a turntable

This unit is compatible with turntables equipped with a moving magnet (MM) phono cartridge. When you connect to a turntable with a low output moving coil (MC) cartridge, use a commercially available MC head amp or a step-up transformer.

If you set this unit's input source to "Phono" and you accidentally increase the volume without having a turntable connected, you may hear a hum noise from the speakers.

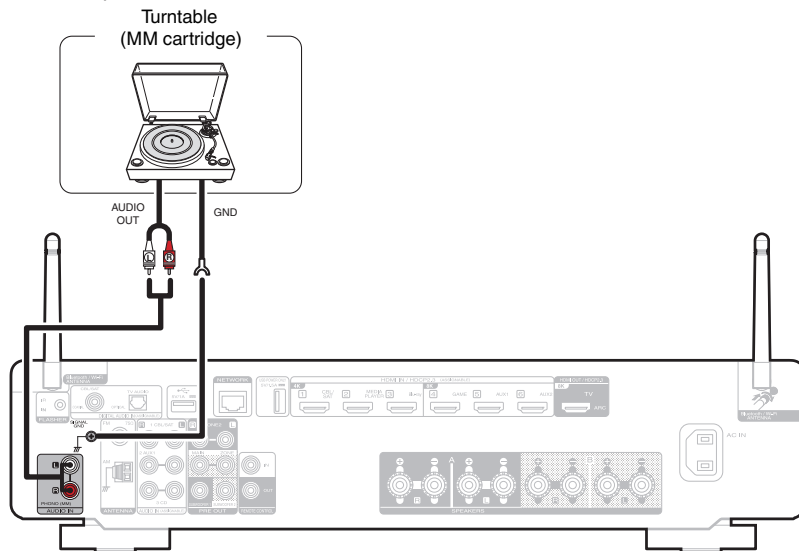

### NOTE

- The earth terminal (SIGNAL GND) of this unit is not for safety grounding purposes. If this terminal is connected when there is a lot of noise, the noise can be reduced. Note that depending on the turntable, connecting the ground line may have the reverse effect of increasing noise. In this case, it is not necessary to connect the ground line.



## Connecting a USB memory device to the USB port

For operating instructions see “Playing a USB memory device” (📖 p. 55).

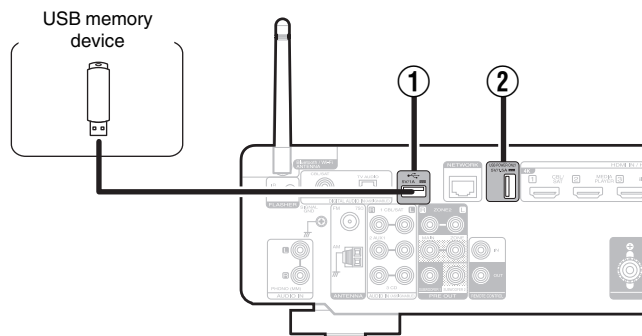

### ① USB port (🔌)

This is used to connect USB storages (such as USB memory devices).

### ② USB port (POWER SUPPLY)

Can be used to power streaming media players, etc.



- Marantz does not guarantee that all USB memory devices will operate or receive power. When using a portable USB hard disk drive (HDD) which came with an AC adapter, use that device's supplied AC adapter.
- The USB port (②) can only be used to supply power (5 V/1.5 A). It cannot be used to play music files.

### NOTE

- USB memory devices will not work via a USB hub.
- It is not possible to use this unit by connecting the unit's USB port to a PC via a USB cable.
- Do not use an extension cable when connecting a USB memory device. This may cause radio interference with other devices.



## Connecting FM/AM antennas

Connect the antenna, tune in to a broadcast and then move the antenna to the location where there is least noise. Then use tape, etc. to fix the antenna in this location. (“Listening to FM/AM broadcasts” (📖 p. 67))



- If you are unable to receive a good broadcast signal, we recommend installing an outdoor antenna. For details, inquire at the retail store where you purchased the unit.

### NOTE

- Make sure the AM loop antenna lead terminals do not touch metal parts of the panel.

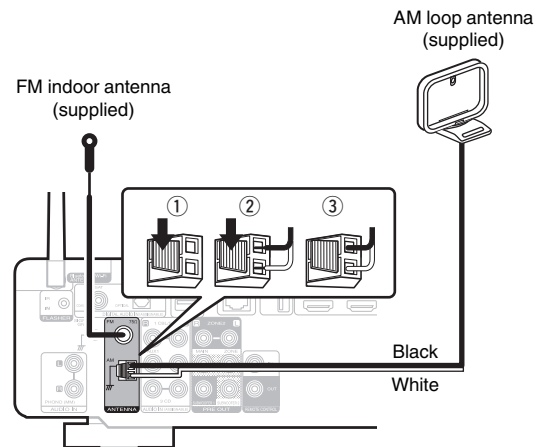

## ■ Using the AM loop antenna

### Suspending on a wall

Suspend directly on a wall without assembling.



### Standing alone

Use the procedure shown above to assemble.

When assembling, refer to “AM loop antenna assembly”.

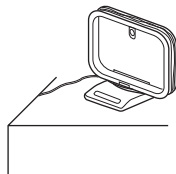

## ■ AM loop antenna assembly

- 1 Put the stand section through the bottom of the loop antenna from the rear and bend it forward.
- 2 Insert the projecting part into the square hole in the stand.

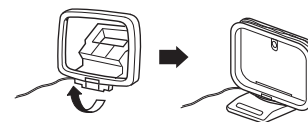
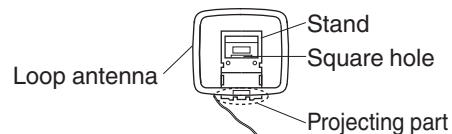

## Connecting to a home network (LAN)

This unit can connect to a network using a wired LAN or wireless LAN. You can connect this unit to your home network (LAN) to enable various types of playback and operations as described below.

- Playback of network audio such as Internet Radio and from your media server(s)
- Playback of streaming music services
- Using the Apple AirPlay function
- Operation on this unit via the network
- Operation with the HEOS wireless multi-room sound system
- Firmware Update

**For connections to the Internet, contact an ISP (Internet Service Provider) or a computer shop.**

### Wired LAN

To make connections via wired LAN, use a LAN cable to connect the router to this unit as shown in the figure below.

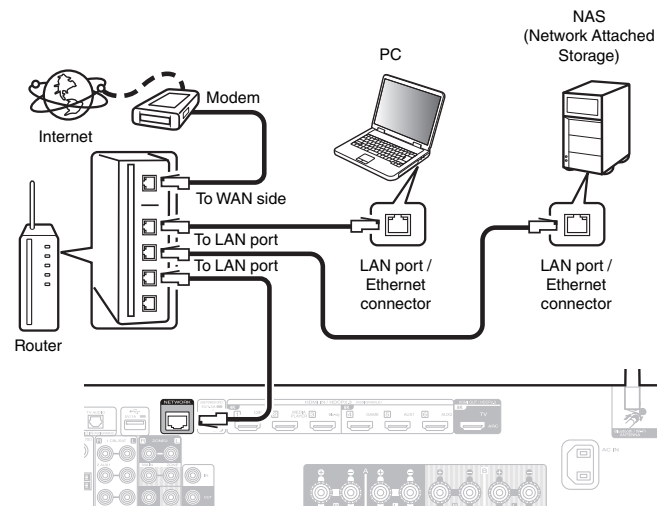

## Wireless LAN

When connecting to a wireless LAN network, stand the rod antenna for Bluetooth/wireless LAN connection upright on the rear panel.

See “Wi-Fi Setup” on how to connect to a wireless LAN router.

(🔍 p. 148)

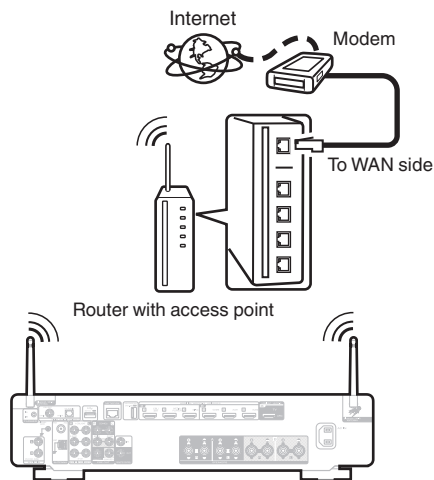

- When using this unit, we recommend you use a router equipped with the following functions:
  - Built-in DHCP server  
This function automatically assigns IP addresses on the LAN.
  - Built-in 100BASE-TX switch  
When connecting multiple devices, we recommend a switching hub with a speed of 100 Mbps or greater.
- Only use a shielded STP or ScTP LAN cable (readily available at electronics stores). (CAT-5 or greater recommended)
- The normal shielded-type LAN cable is recommended.  
If a flat-type cable or unshielded-type cable is used, other devices could be affected by noise.
- When using this unit connected to a network with no DHCP function, configure the IP address, etc. in "Network". (🔍 p. 147)

### NOTE

- The types of routers that can be used depend on the ISP. Contact your ISP or a computer shop for details.
- This unit is not compatible with PPPoE. A PPPoE compatible router is required if your contracted line is not set using PPPoE.
- Do not connect a NETWORK connector directly to the LAN port / Ethernet connector on your computer.
- Various online services may be discontinued without prior notice.



## Connecting an external control device

### REMOTE CONTROL jacks

If the remote control jack of this unit is connected with the remote control terminal of a Marantz device, the connected device can be controlled with the remote as a single system.

#### ■ When controlling a connected device from this unit

- Connect the REMOTE CONTROL OUT jack of this unit to the REMOTE CONTROL IN jack of the device to be connected.
- Point the remote control operations towards this unit. The transmitted infrared signal from the remote control is received by the remote control infrared receiver of this unit and is sent to the other devices through the remote control jack.
- If there is a remote control switch on the back of the device to be connected with this unit, set it to “EXTERNAL” or “EXT.”.
- If you connect the Marantz power amp (including Hi-Fi amplifier) to any of these terminals, the power of the power amp operates in conjunction with the power of this unit.

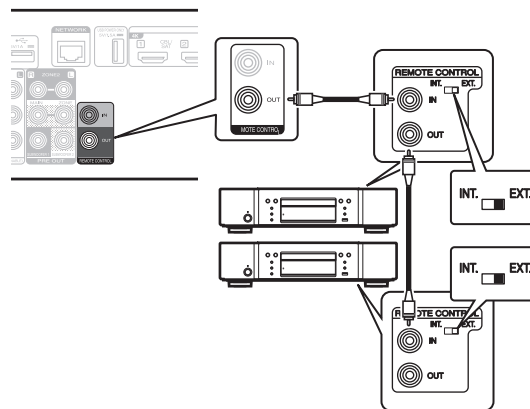



## ■ When controlling this unit from a connected device

- Connect to the REMOTE CONTROL IN jack of this unit from the REMOTE CONTROL OUT jack of the device to be connected.
- If you perform this operation, disable the remote sensor function of this unit using the “Remote lock function”. (👉 p. 113)

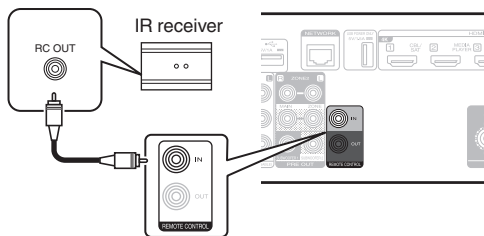

### NOTE

- When the remote control signal receiving function is disabled, you can not perform operations with the remote control unit.



## FLASHER IN jack

If a commercially available (sold separately) IR repeater is connected to the FLASHER IN jack of this unit, remote control operations can be performed even if this unit is installed in a place where the remote control signal may not reach, such as in a cabinet.

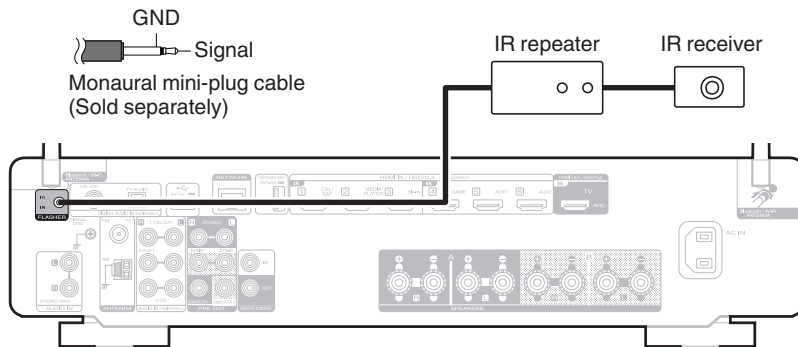

## Connecting the power cord

After completing all the connections, insert the power plug into the power outlet.

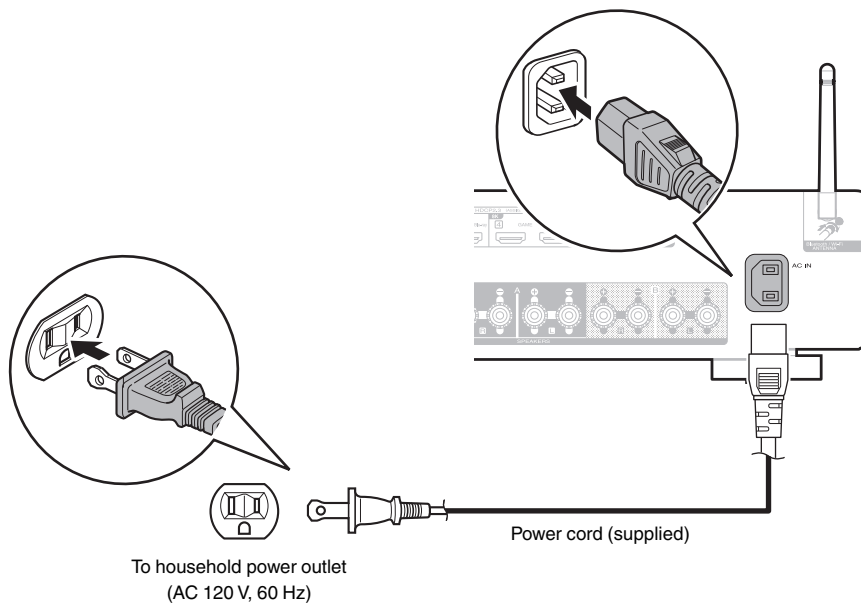

## ■ Contents

### Basic operation

Turning the power on	53
Selecting the input source	53
Adjusting the volume	54
Turning off the sound temporarily (Muting)	54
Selecting a sound mode	102

### Playback a device

Playing a Blu-ray Disc player/DVD player	54
Playing a USB memory device	55
Listening to music on a Bluetooth device	59
Listening to audio on Bluetooth headphones	63
Listening to FM/AM broadcasts	67

### Playback network audio/service

Listening to Internet Radio	75
Playing back files stored on a PC or NAS	77
Getting the HEOS App	81
AirPlay function	90
Spotify Connect function	93

### Convenience functions

Convenience functions	94
HDMI Control function	104
Sleep timer function	105
Smart select function	107
Panel lock function	111
Remote lock function	113

### Other functions

Web control function	115
Playback in ZONE2 (Another room)	117



## Basic operation

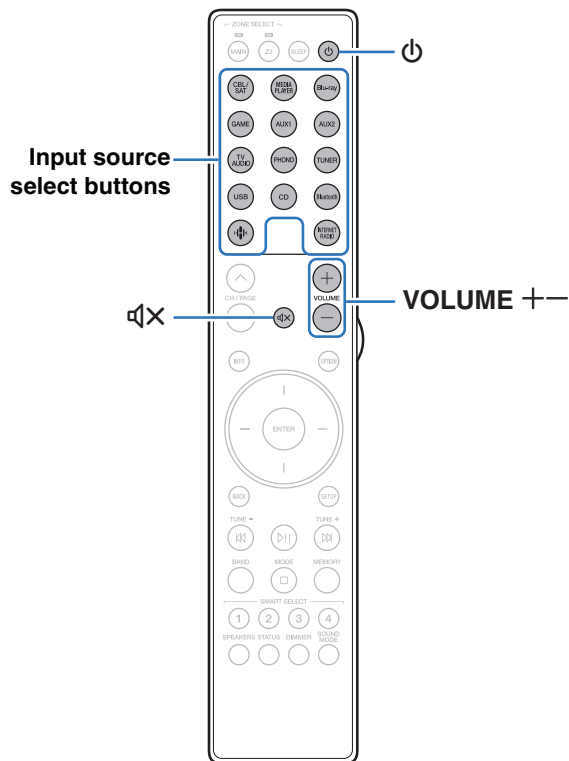

### Turning the power on

**1** Press POWER to turn on power to the unit.



- You can press the input source select button when the unit is in standby mode to turn on the power.
- You can also switch the power to standby by pressing on the main unit.

### Selecting the input source

**1** Press the input source select button to be played back.  
The desired input source can be selected directly.



- You can also select the input source by turning INPUT selector on the main unit.



## Adjusting the volume

### 1 Use VOLUME $\pm$ to adjust the volume.



- The variable range differs according to the input signal and channel level setting.
- You can also adjust the master volume by turning VOLUME on the main unit.

## Turning off the sound temporarily (Muting)

### 1 Press MUTE $\text{M}$ .

- MUTE indicator on the display flashes.
- $\text{M}$  appears on the TV screen.



- The sound is reduced to the level set at "Mute Level" in the menu. (👉 p. 130)
- To cancel mute, either adjust the sound volume or press MUTE  $\text{M}$  again.
- If  $\text{M}$  is displayed on the TV screen for more than 5 minutes when the "Screen Saver" is set to "On", the  $\text{M}$  symbol moves randomly over the TV screen. (👉 p. 137)

## Playback a Blu-ray Disc player/DVD player

The following describes the procedure for playing Blu-ray Disc player/DVD player.

### 1 Prepare for playback.

- ① Turn on the power of the TV, subwoofer and player.
- ② Change the TV input to the input of this unit.

### 2 Press POWER $\text{P}$ to turn on power to the unit.

### 3 Press Blu-ray to switch an input source for a player used for playback.

### 4 Play the Blu-ray Disc player or DVD player.



- This unit supports analog audio signals and PCM 2-channel signals. To play DVDs and Blu-ray Discs, set "PCM 2ch" as the audio format in the audio device settings.



## Playing a USB memory device

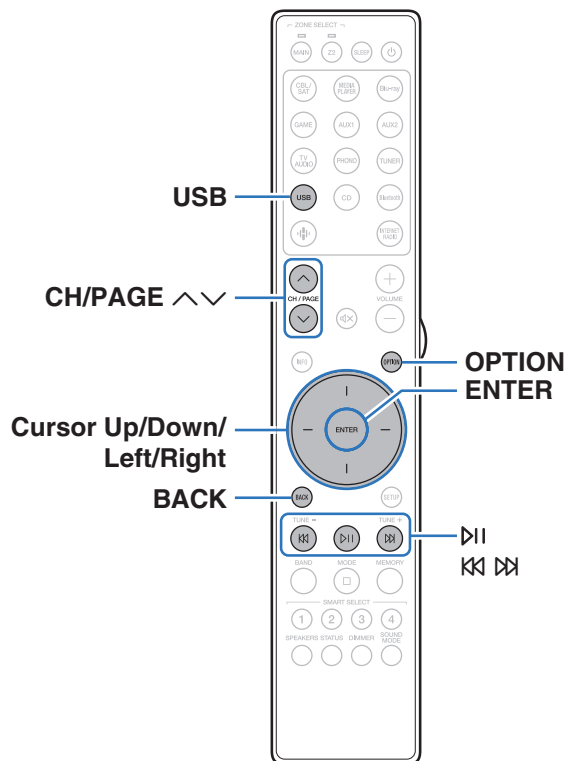

- Playing back music files stored on a USB memory device.
- Only USB memory devices conforming to mass storage class standards can be played on this unit.
- This unit is compatible with USB memory devices in “FAT32” or “NTFS” format.
- The audio format types and specifications supported by this unit for playback are as follows.  
See “Playing back a USB memory devices” (p. 202) for details.

- **WMA**
- **MP3**
- **WAV**
- **MPEG-4 AAC**
- **FLAC**
- **Apple Lossless**
- **DSD**



## Playing files stored on USB memory devices

- 1 Insert a “FAT32” or “NTFS” formatted USB memory device into the USB port.
- 2 Press USB to switch the input source to “USB”.
- 3 Select the name of this unit.

### 4 Browse the music on your USB memory device and select something to play.



- When you select something to play you will be asked how you want to queue up your music.

<b>Play Now:</b>	Inserts the item into the queue after the currently playing track and plays the selected item immediately.
<b>Play Now &amp; Replace Queue:</b>	Clears the queue and plays the selected item immediately.
<b>Play Next:</b>	Inserts the item into the queue after the current song and plays it when the current song ends.
<b>Add to End of Queue:</b>	Adds the item to the end of the queue.

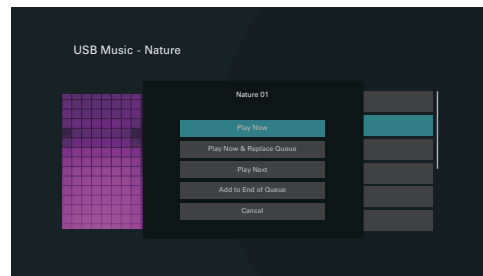



## 5 Use cursor Up/Down to select the “Play Now” or “Play Now & Replace Queue”, then press ENTER.

Playback starts.

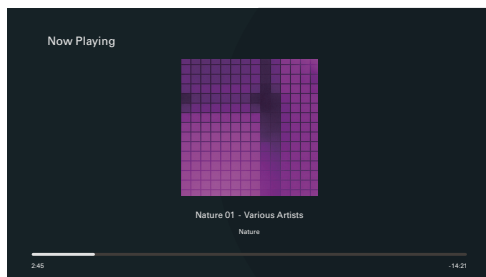

Operation buttons	Function
▶	Playback / Pause
⏮ ⏭	Skip to previous track / Skip to next track
CH/PAGE ^ v	Switch to the previous page/next page in the list display



- When an MP3 music file includes album art data, the album art can be displayed while playing the file.

### NOTE

- Note that Marantz will accept no responsibility whatsoever for any problems arising with the data on a USB memory device when using this unit in conjunction with the USB memory device.
- When a USB memory device is connected to this unit, the unit loads all of the files on the USB memory device. Loading may take a while if the USB memory device contains a large number of folders and/or files.



## ■ Operations accessible through the option menu

- “Adjust the sound output balance of left and right speakers (Balance)” (👉 p. 96)
- “Adjust the subwoofer output (Subwoofer)” (👉 p. 97)
- “Adjusting the tone (Tone)” (👉 p. 98)
- “Adjusting audio delay (Audio Delay)” (👉 p. 99)
- “Displaying your desired video during audio playback (Video Select)” (👉 p. 100)
- “Playing the same music in all zones (All Zone Stereo)” (👉 p. 101)



## Listening to music on a Bluetooth device

Music files stored on Bluetooth devices such as smartphones, digital music players, etc. can be enjoyed on this unit by pairing and connecting this unit with the Bluetooth device.

Communication is possible up to a range of about 98.4 ft/30 m.

### NOTE

- To play back music from a Bluetooth device, the Bluetooth device needs to support the A2DP profile.

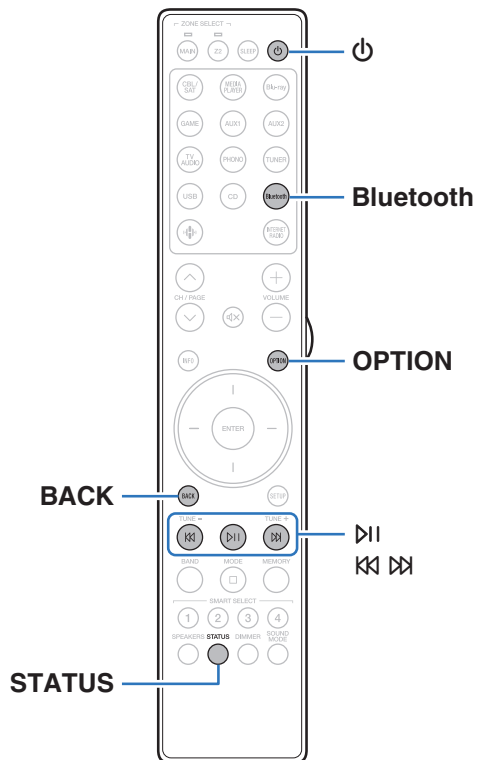

## Playing music from Bluetooth device

In order to enjoy music from a Bluetooth device on this unit, the Bluetooth device must first be paired with this unit.

Once the Bluetooth device has been paired, it does not need to be paired again.

### 1 Prepare for playback.

- ① Connect the supplied external antennas for Bluetooth/wireless connectivity to the Bluetooth/wireless LAN antenna connectors on the rear panel. (👉 p. 21)
- ② Press POWER  to turn on power to the unit.

### 2 Press Bluetooth.

When using for the first time, the unit will go into the pairing mode automatically and “Pairing...” will appear on the display of the unit.

### 3 Activate the Bluetooth settings on your mobile device.



### 4 Select this unit when its name appears in the list of devices displayed on the screen of the Bluetooth device.

Connect to the Bluetooth device while “Pairing” is being displayed on the display of the unit.

Perform the connection with the Bluetooth device close to the unit (about 3.3 ft/1 m).

### 5 Play music using any app on your Bluetooth device.

- The Bluetooth device can also be operated with the remote control of this unit.
- The next time the Bluetooth button is pressed on the remote control unit, this unit automatically connects to the last Bluetooth device that was connected.

Operation buttons	Function
	Playback / Pause
	Skip to previous track / Skip to next track



- Press STATUS on the remote control during playback to switch the display between Title name, Artist name, Album name, etc.



## Pairing with other Bluetooth devices

Pair a Bluetooth device with this unit.

- 1 Activate the Bluetooth settings on your mobile device.**
- 2 Press and hold Bluetooth on the remote control unit for at least 3 seconds.**  
This unit will go into the pairing mode.
- 3 Select this unit when its name appears in the list of devices displayed on the screen of the Bluetooth device.**



- This unit can be paired with a maximum of 8 Bluetooth devices. When a 9th Bluetooth device is paired, it will be registered in place of the oldest registered device.
- You can also enter pairing mode by pressing the OPTION button when the Bluetooth playback screen is displayed and selecting "Pairing Mode" from the displayed option menu.

### NOTE

- To operate the Bluetooth device with the remote control of this unit, the Bluetooth device needs to support the AVRCP profile.
- The remote control of this unit is not guaranteed to work with all Bluetooth devices.
- Depending on the type of Bluetooth device, this unit outputs audio that is coupled to the volume setting on the Bluetooth device.

### ■ Operations accessible through the option menu

- "Pairing with other Bluetooth devices" (👉 p. 61)
- "Adjust the sound output balance of left and right speakers (Balance)" (👉 p. 96)
- "Adjust the subwoofer output (Subwoofer)" (👉 p. 97)
- "Adjusting the tone (Tone)" (👉 p. 98)
- "Adjusting audio delay (Audio Delay)" (👉 p. 99)
- "Displaying your desired video during audio playback (Video Select)" (👉 p. 100)
- "Playing the same music in all zones (All Zone Stereo)" (👉 p. 101)



## Reconnecting to this unit from a Bluetooth device

After pairing is completed, the Bluetooth device can be connected without performing any operations on this unit.

This operation also needs to be performed when switching the Bluetooth device for playback.

- 1 If a Bluetooth device is currently connected, deactivate the Bluetooth setting of that device to disconnect it.**
- 2 Activate the Bluetooth setting of the Bluetooth device to be connected.**
- 3 Select this unit from the Bluetooth device list on your Bluetooth device.**
- 4 Play music using any app on your Bluetooth device.**



- The screen automatically switches to the “Bluetooth” playback screen if a Bluetooth device is connected while the power of this unit is on.
- When the “Network Control” setting of this unit is set to “Always On” and a Bluetooth device is connected with the unit in the standby state, the power of the unit will be turned on automatically. (🔗 p. 151)



## Listening to audio on Bluetooth headphones

You can listen to audio playing through the MAIN ZONE of this unit on Bluetooth headphones. Output audio from connected speakers and Bluetooth headphones simultaneously, or only using Bluetooth headphones.

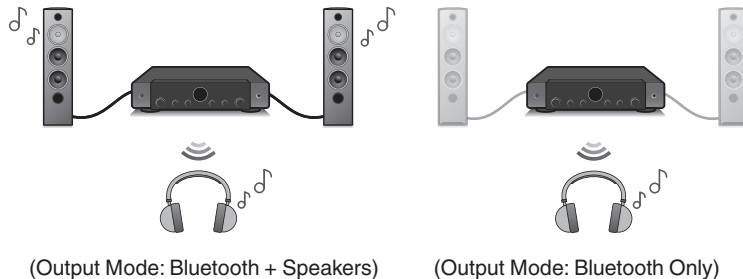

## Listening to audio on Bluetooth headphones

- 1 Set “Transmitter” to “On” from the “General” - “Bluetooth Transmitter” setting in the menu. (🔑 p. 160)
- 2 Select “Output Mode”, and set audio output method.
 

<b>Bluetooth + Speakers</b> (Default):	Audio is output to Bluetooth headphones and main zone speakers. This simultaneous output is suitable for family movie night and other group activities.
<b>Bluetooth Only:</b>	Audio is output to Bluetooth headphones only. This is suitable for listening to music or watching movies by yourself at night when you need to keep quiet.
- 3 Enter pairing mode on the Bluetooth headphones you want to connect to this unit.
- 4 Select “Device List” and select the name of the Bluetooth headphones from the device list.
- 5 Adjust the volume of connected Bluetooth headphones after the connection is completed.



- “Output Mode” can also be set from “Bluetooth Transmitter” in the option menu.
- A2DP profile-compatible Bluetooth speakers can be connected following the same steps used to connect Bluetooth headphones.

### NOTE

- Bluetooth headphone volume cannot be adjusted by the VOLUME knob on this unit or the VOLUME buttons on the remote control unit. Adjust the volume using the Bluetooth headphones.
- If you are using Bluetooth headphones that do not have volume control, or if the volume is insufficient, you can control the volume by adjusting the “Level” of the “Bluetooth Transmitter” from the options menu. (🔑 p. 65)
- Stereo mode is fixed as the sound mode when using Bluetooth headphones. Any sound modes and other audio settings are not reflected in audio output on Bluetooth headphones. Audio settings, sound modes and All Zone Stereo mode are not available while using Bluetooth headphones and “Output Mode” is set to “Bluetooth Only”.
- Audio may be delayed when sent over Bluetooth.
- AirPlay audio cannot be transmitted.
- Bluetooth headphones cannot be connected when use a Bluetooth input source in any zone. Furthermore, selecting a Bluetooth input source in any zone will terminate the connection between this unit and Bluetooth headphones.
- Bluetooth headphones cannot be connected when this unit is grouped in the HEOS App.





## Adjusting the volume of Bluetooth headphones

If you are using Bluetooth headphones that do not have volume control, or if the volume is insufficient, you can control the volume by adjusting the “Level” of the “Bluetooth Transmitter” from the options menu.

### 1 Press **OPTION**.

An option menu screen is displayed.

- When the input source is “HEOS Music”, an option menu for online music is displayed. Select “Receiver Options...”, then press **ENTER**.

### 2 Use cursor **Up/Down** to select “Bluetooth Transmitter”, then press **ENTER**.

The “Bluetooth Transmitter” screen is displayed.

### 3 Use cursor **Up/Down** to select “Level”.

### 4 Use cursor **Left/Right** to adjust the volume, then press **ENTER**.

---

–50 dB – +10 dB (Default: 0 dB)

---



- This setting applies to all connected Bluetooth headphones, regardless of type.

## Reconnecting to a Bluetooth headphones

Follow any of the steps below to reconnect the most recently used Bluetooth headphones:

- Reconnect to this unit with Bluetooth headphone's reconnect function.
- Go to “Bluetooth Transmitter” and then select “Reconnect” within the options menu.
- If “Output Mode” is set to “Bluetooth + Speakers”, this unit will automatically connect to the most recently used Bluetooth headphones when power is turned on.
- Select the device you wish to connect from the “Device List” under “Bluetooth Transmitter” in the menu. (🔍 p. 160)



## Disconnecting Bluetooth headphones

Complete any of the following steps to disconnect your Bluetooth headphones:

- Turn off your Bluetooth headphones.
- Go to “Bluetooth Transmitter” and then select “Disconnect” within the options menu.
- In the setup menu, go to “General” - “Bluetooth Transmitter”, and set “Transmitter” to Off. (🔍 p. 160)



## Listening to FM/AM broadcasts

You can use the built-in tuner of this unit to listen to FM broadcasts and AM broadcasts.

Make sure the FM antenna and AM loop antenna are connected to this unit first.

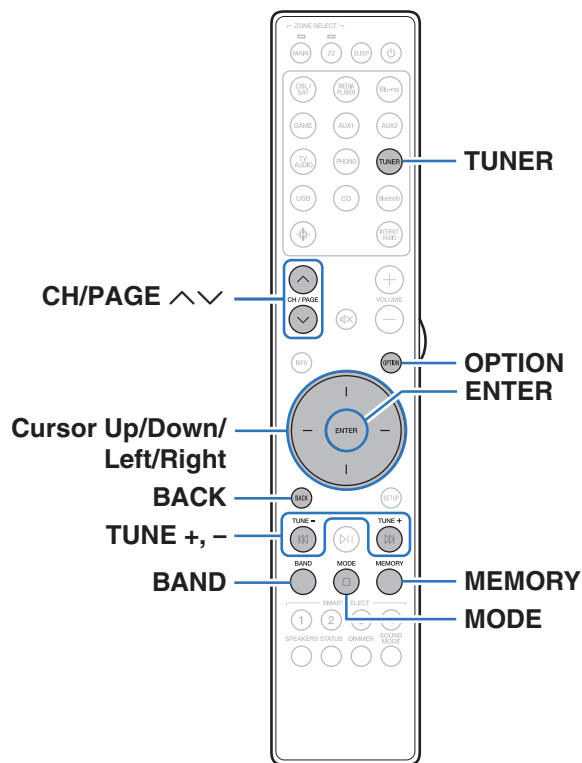

## Listening to FM/AM broadcasts

- 1 Connect the antenna. (“Connecting FM/AM antennas” (🔧 p. 44))
- 2 Press TUNER to switch the input source to “Tuner”.

[ TV screen ]

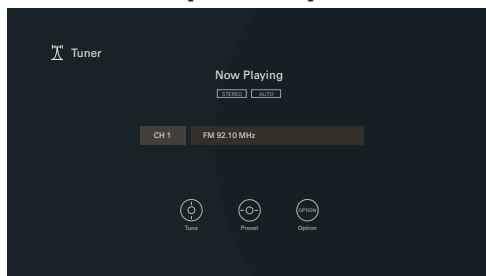

[ Display of this unit ]

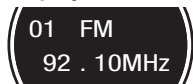

- 3 Press OPTION.  
The option menu screen is displayed.
- 4 Use cursor Up/Down to select “FM/AM”, then press ENTER.  
This displays the reception band input screen.

- 5 Use cursor Left/Right to select “FM” or “AM”, then press ENTER.

FM: \_\_\_\_\_ When listening to an FM broadcast.

AM: \_\_\_\_\_ When listening to an AM broadcast.

- 6 Press TUNE + or TUNE – to select the station you want listen to.

Scanning is performed until it finds an available radio station. When it finds a radio station, it stops the scan automatically and tunes in.



- The modes for receiving FM broadcasts consists of “Auto” mode that automatically searches available broadcast stations and “Manual” mode that lets you tune in using buttons to change the frequency. The default setting is “Auto”. You can also use “Direct Tune” to tune in by entering the frequency directly.  
In “Auto” mode, you cannot tune in to radio stations if the reception is not good. If this is the case, then use the “Manual” mode or “Direct Tune” mode to tune in.

Operation buttons	Function
TUNE +, –	Selects the radio station (up/down)
BAND	Switches between FM and AM
MODE	Switching tuning mode
MEMORY	Register presets
CH/PAGE ^v	Selects preset radio stations
Cursor Up/Down	Selects the radio station (up/down)
Cursor Left/Right	Selects preset radio stations



## ■ Operations accessible through the option menu

- “Tuning in by entering the frequency (Direct Tune)” (🔍 p. 69)
- “Changing the tune mode (Tune Mode)” (🔍 p. 70)
- “Tuning in to stations and presetting them automatically (Auto Preset Memory)” (🔍 p. 70)
- “Presetting the current broadcast station (Preset Memory)” (🔍 p. 71)
- “Specify a name for the preset broadcast station (Preset Name)” (🔍 p. 72)
- “Skipping preset broadcast stations (Preset Skip)” (🔍 p. 73)
- “Adjust the sound output balance of left and right speakers (Balance)” (🔍 p. 96)
- “Adjust the subwoofer output (Subwoofer)” (🔍 p. 97)
- “Adjusting the tone (Tone)” (🔍 p. 98)
- “Adjusting audio delay (Audio Delay)” (🔍 p. 99)
- “Displaying your desired video during audio playback (Video Select)” (🔍 p. 100)
- “Playing the same music in all zones (All Zone Stereo)” (🔍 p. 101)

## Tuning in by entering the frequency (Direct Tune)

You can enter the receiving frequency directly to tune in.

- 1 Press OPTION when the input source is “Tuner”.**  
The option menu screen is displayed.
- 2 Use cursor Up/Down to select “Direct Tune”, then press ENTER.**  
The screen that lets you enter the frequency is displayed.
- 3 Use cursor Up/Down to select a number, then press cursor Right.**
  - If cursor Left is pressed, the immediately preceding input is cancelled.
- 4 Repeat step 3 and enter the frequency of the radio station you want to hear.**
- 5 When setting is completed, press ENTER.**  
The preset frequency is tuned in.



## Changing the tune mode (Tune Mode)

You can change the mode for tuning into FM and AM broadcasts. If you cannot tune in automatically with “Auto” mode, change the mode to “Manual” and tune in manually.

- 1 Press OPTION when the input source is “Tuner”.**  
The option menu screen is displayed.
- 2 Use cursor Up/Down to select “Tune Mode”, then press ENTER.**
- 3 Use cursor Left/Right to select the tune mode, then press ENTER.**

<b>Auto:</b>	Automatically search for and tune to a receivable radio station.
<b>Manual:</b>	Manually change the frequency one step at a time each time the button is pressed.

## Tuning in to stations and presetting them automatically (Auto Preset Memory)

A maximum of 56 radio stations can be automatically preset.

- 1 Press OPTION when the input source is “Tuner”.**  
The option menu screen is displayed.
- 2 Use cursor Up/Down to select “Auto Preset Memory”, then press ENTER.**
- 3 Press ENTER.**  
The unit starts to tune in to radio stations automatically and preset them.
  - When presetting is completed, “Completed” is displayed for about 5 seconds and the option menu screen turns off.



- The preset memory is overwritten.



## Presetting the current broadcast station (Preset Memory)

Your favorite broadcast stations can be preset so that you can tune them in easily.

Up to 56 stations can be preset.

- 1 Tune in the broadcast station you want to preset.**  
("Listening to FM/AM broadcasts" (🔍 p. 68))
- 2 Press OPTION.**  
The option menu screen is displayed.
- 3 Use cursor Up/Down to select "Preset Memory", then press ENTER.**  
The list of already preset channels is displayed.
- 4 Use cursor Up/Down to select the channel you want to preset, then press ENTER.**

The current broadcast station that is preset.

- To preset other stations, repeat steps 1 to 4.



- You can preset your favorite broadcast station by pressing MEMORY on the remote control unit.

1. Tune in the broadcast station you want to preset.  
("Listening to FM/AM broadcasts" (🔍 p. 68))
2. Press MEMORY.
3. Use cursor Up/Down to select the channel you want to preset.
4. Press MEMORY.

Channel	Default settings
1 – 8	92.10 / 92.30 / 92.50 / 92.70 / 93.10 / 93.50 / 93.70 / 94.10 MHz
9 – 16	94.30 / 94.50 / 94.70 / 94.90 / 95.10 / 95.30 / 95.50 / 95.70 MHz
17 – 24	98.10 / 98.30 / 98.50 / 98.70 / 98.90 / 99.10 / 100.10 / 100.30 MHz
25 – 32	100.50 / 100.70 / 100.90 / 101.10 / 101.30 / 101.50 / 101.70 / 101.90 MHz
33 – 40	103.10 / 103.30 / 103.50 / 103.70 / 103.90 / 104.10 / 104.30 / 104.50 MHz
41 – 48	104.70 / 104.90 / 105.10 / 105.30 / 105.50 / 105.70 / 105.90 / 106.10 MHz
49 – 56	106.30 / 106.50 / 106.70 / 106.90 / 107.10 / 107.30 / 107.50 / 107.90 MHz

## Listening to preset stations

- 1 Use CH/PAGE  $\wedge$   $\vee$  to select the desired preset channel.**



## Specify a name for the preset broadcast station (Preset Name)

You can set the name to the preset broadcast station or change it. Up to 8 characters can be input.

### 1 Press **OPTION** when the input source is “Tuner”.

The option menu screen is displayed.

### 2 Use cursor **Up/Down** to select “Preset Name”, then press **ENTER**.

The “Preset Name” screen is displayed.

### 3 Use cursor **Left/Right** to select the group of the broadcast station you want to name.

### 4 Use cursor **Up/Down** to select the broadcast station you want to name, then press **ENTER**.

The screen that lets you edit the Preset Name is displayed.

- If you select “Clear”, then the unit returns to displaying the frequency.

### 5 Enter the characters, then press “OK”.

### 6 Press **OPTION** to return to the previous screen.





## Skipping preset broadcast stations (Preset Skip)

Perform auto preset memory to save all the broadcasting stations that can be received in the memory. Selecting a broadcast station becomes easier by skipping unnecessary memories.

### 1 Press **OPTION** when the input source is “Tuner”.

The option menu screen is displayed.

### 2 Use cursor **Up/Down** to select “Preset Skip”, then press **ENTER**.

The “Preset Skip” screen is displayed.

### 3 To set the stations you want to skip by groups

- ① Use cursor **Left/Right** to select the group of broadcast stations you want to skip.
- ② Press cursor **Up** to select “Set \* - \* to Skip”, then press **ENTER**.

Skip all the broadcast stations that are included in the selected group “\* - \*”.

(\* is the selected group number.)

### To set the stations you want to skip by stations

- ① Use cursor **Left/Right** to select the group of broadcast stations you want to skip.
- ② Use cursor **Up/Down** to select the broadcast station you want to skip.
- ③ Use cursor **Left/Right** to select “Skip”.  
The station you selected is not displayed.

### 4 Press **OPTION** to return to the previous screen.



## Cancelling Preset Skip

- 1** While the “Preset Skip” screen is displayed, use cursor Left/Right to select a group containing a broadcast station to cancel the skip for.
- 2** Use cursor Up/Down to select a broadcast station to cancel the skip for.
- 3** Use cursor Left/Right to select “On”.  
The skip is cancelled.

### NOTE

- “Preset Skip” cannot be cancelled for groups.



# Listening to Internet Radio

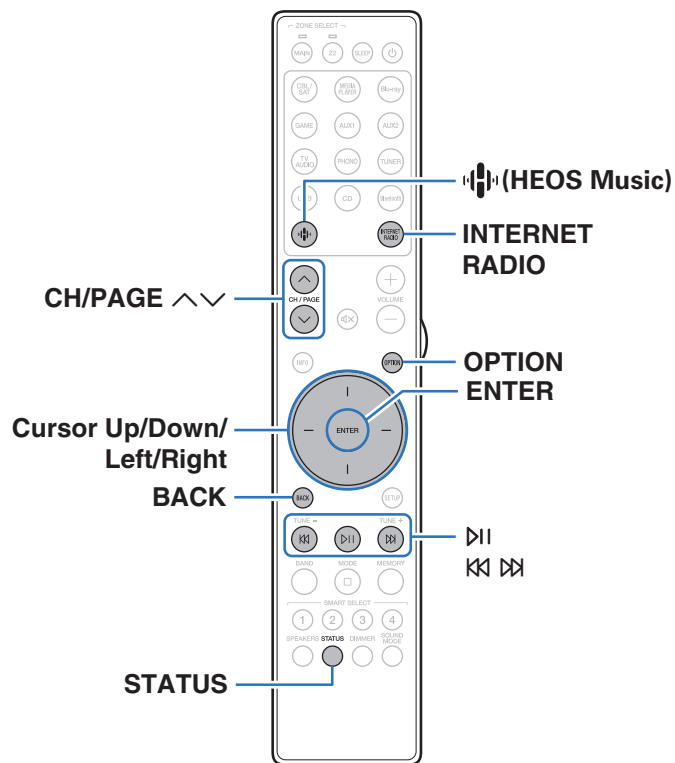

- Internet Radio refers to radio broadcasts distributed over the Internet. Internet Radio stations from around the world can be received.
- The Internet Radio station list on this unit the database service provided by TuneIn Radio service.
- The audio format types and specifications supported by this unit for playback are as follows.  
See “Playing back Internet Radio” (p. 205) for details.

- WMA
- MP3
- MPEG-4 AAC





## Listening to Internet Radio

### 1 Press INTERNET RADIO.

- You can also press  (HEOS Music). Use cursor Up/Down to select "TuneIn Internet Radio", then press ENTER.

### 2 Select the station you want to play.

Operation buttons	Function
 *	Playback / Pause
 *	Skip to previous track / Skip to next track
CH/PAGE 	Switch to the previous page/next page in the list display

\* Enabled when playing Podcasts.









- The display switches between track title and radio station name etc. each time the STATUS on the remote control is pressed.

#### NOTE

- The radio station database service may be suspended or be otherwise unavailable without notice.

### ■ Operations accessible through the option menu

- "Adding to HEOS Favorites" ( p. 96)
- "Adjust the sound output balance of left and right speakers (Balance)" ( p. 96)
- "Adjust the subwoofer output (Subwoofer)" ( p. 97)
- "Adjusting the tone (Tone)" ( p. 98)
- "Adjusting audio delay (Audio Delay)" ( p. 99)
- "Displaying your desired video during audio playback (Video Select)" ( p. 100)
- "Playing the same music in all zones (All Zone Stereo)" ( p. 101)



## Playing back files stored on a PC or NAS

- This unit can play back music files and playlists (m3u, wpl) from DLNA compatible servers including PCs and NAS devices on your network.

- Supported file formats:

For details, see “Playing back a file saved on a PC or NAS” (🔍 p. 204).

- WMA
- MP3
- WAV
- MPEG-4 AAC
- FLAC
- Apple Lossless
- DSD

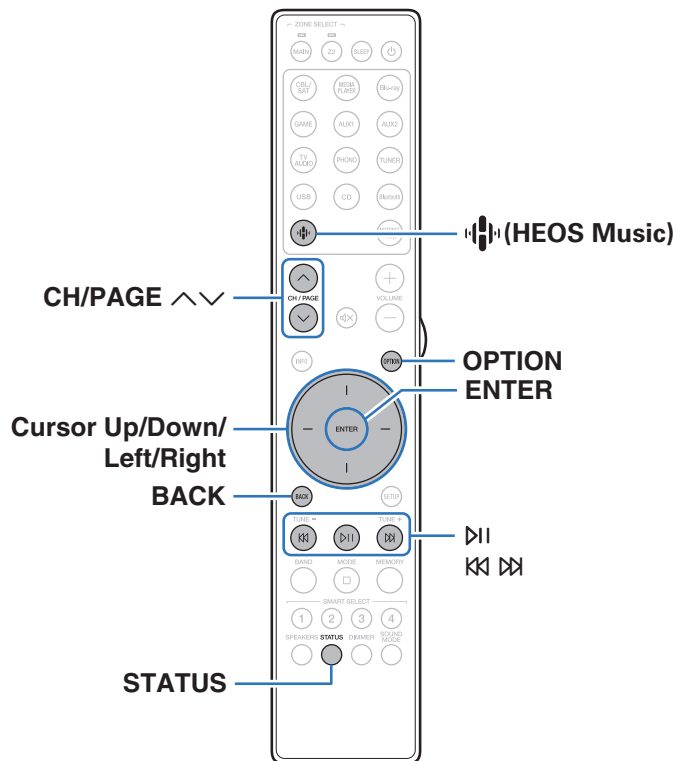

## Playing back files stored on a PC or NAS

Use this procedure to play music files or playlists stored on DLNA files servers on your local network.

### 1 Press **HEOS Music**.

If a playback history is present, the last Internet radio station or song played is played back. Pressing **HEOS Music** again displays the HEOS Music top menu.

### 2 Use cursor Up/Down to select “Music Servers”, then press ENTER.

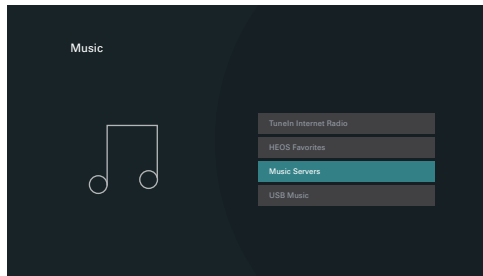

### 3 Select the name of your networked PC or NAS (Network Attached Storage) server.

## 4 Browse the music on your PC/NAS and select something to play.



- When you select something to play you will be asked how you want to queue up your music.

<b>Play Now:</b>	Inserts the item into the queue after the currently playing track and plays the selected item immediately.
<b>Play Now &amp; Replace Queue:</b>	Clears the queue and plays the selected item immediately.
<b>Play Next:</b>	Inserts the item into the queue after the current song and plays it when the current song ends.
<b>Add to End of Queue:</b>	Adds the item to the end of the queue.

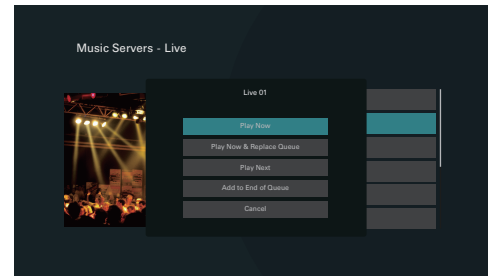

## 5 Use cursor Up/Down to select the “Play Now” or “Play Now & Replace Queue”, then press ENTER.

Playback starts.

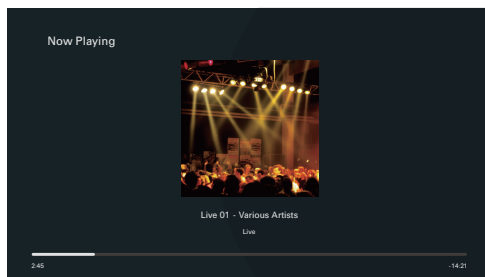

Operation buttons	Function
⏮   ⏭	Playback / Pause
⏮ ⏭	Skip to previous track / Skip to next track
CH/PAGE ⏪ ⏩	Switch to the previous page/next page in the list display



- The display switches between track title, artist name, and album title each time the STATUS on the remote control is pressed.
- When a WMA (Windows Media Audio), MP3 or MPEG-4 AAC file includes album art data, the album art can be displayed while the music files are playing.
- If you use Ver.11 or later of Windows Media Player, the album art for WMA files can be displayed.

### NOTE

- When playing back music files with your PC or NAS connected through wireless LAN, audio may be interrupted depending on your wireless LAN environment. In this case, connect using a wired LAN.
- The order in which the tracks/files are displayed depends on the server specifications. If the tracks/files are not displayed in alphabetical order due to the server specifications, searching by the first letter may not work properly.



## ■ Operations accessible through the option menu

- “Adjust the sound output balance of left and right speakers (Balance)” (👉 p. 96)
- “Adjust the subwoofer output (Subwoofer)” (👉 p. 97)
- “Adjusting the tone (Tone)” (👉 p. 98)
- “Adjusting audio delay (Audio Delay)” (👉 p. 99)
- “Displaying your desired video during audio playback (Video Select)” (👉 p. 100)
- “Playing the same music in all zones (All Zone Stereo)” (👉 p. 101)





## Getting the HEOS App

---

You can use many online music streaming services from the HEOS App. Depending upon your geographical location, there are several options to choose from.

Download the HEOS App for iOS or Android by searching App Store, Google Play store or Amazon Appstore for "HEOS".



## HEOS Account

HEOS Accounts can be registered by tapping “Music” tab - “Settings” icon  in the HEOS App.

Once you create or sign into your HEOS Account, you can use the HEOS Favorites feature to save and recall your favorite streaming radio stations using the on-screen user interface on your stereo receiver.

### ■ What is a HEOS Account?

A HEOS Account is master account or “keychain” for managing all of your HEOS music services with one single username and password.

### ■ Why do I need a HEOS Account?

With the HEOS Account you just have to enter your music services login names and passwords one time. This allows you to easily and quickly use multiple controller apps on different devices.

You just log into your HEOS Account on any device and you will have access to all of your associated music services, play history and custom playlists, even if you are at a friend’s house listening to music on their HEOS system.

### ■ Signing up for a HEOS Account

You will be instructed to signup for a HEOS Account the first time you try to access any music service from the main “Music” menu of the HEOS App.

## ■ Changing your HEOS Account

- 1 Tap the “Music” tab.**
- 2 Select the Settings icon  in the upper left corner of the screen.**
- 3 Select “HEOS Account”.**
- 4 Change your location, change your password, delete your account or sign out of your account.**



- This unit automatically synchronizes when you change your settings or sign out of your account in the HEOS App.



## Playing from streaming music services

A music service is an online music company that provides access to vast music collections via free and/or paid subscriptions. Depending upon your geographical location, there are several options to choose from.

### NOTE

- The HEOS App and brand is not affiliated with any manufacturer of any mobile device. Availability of music services may vary by region. Not all services may be available at time of purchase. Some services may be added or discontinued from time to time based on decisions of the music service providers or others.

## ■ Selecting a room/device

- 1 Tap the “Rooms” tab, and select “Marantz STEREO 70s” if there are multiple products with HEOS Built-in.



- Tap the Pencil icon  at the top right to switch edit mode. You can change the displayed name.

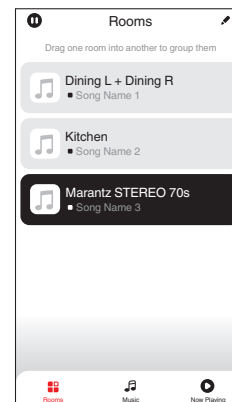

## ■ Selecting the music track or station from music sources

### 1 Tap the “Music” tab and select a music source.



- All music services displayed may not be available in your location.

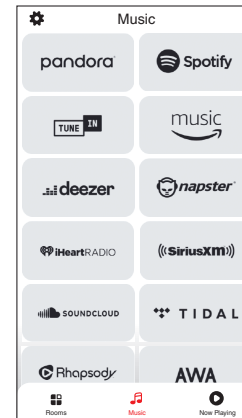

## 2 Browse the music to play.

After selecting a music track or radio station the app will automatically change to the “Now Playing” screen.



- When you select a music track to play you will be asked how you want to queue up your music.

<b>Play Now:</b>	Inserts the item into the queue after the currently playing track and plays the selected item immediately.
<b>Play Now &amp; Replace Queue:</b>	Clears the queue and plays the selected item immediately.
<b>Play Next:</b>	Inserts the item into the queue after the current song and plays it when the current song ends.
<b>Add to End of Queue:</b>	Adds the item to the end of the queue.



- When you select a radio station the following items are displayed.

<b>Play Now:</b>	Plays the selected item immediately.
<b>Add to HEOS Favorites:</b>	Adds to HEOS Favorites.

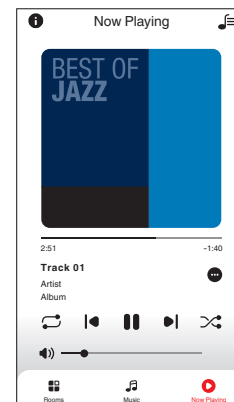
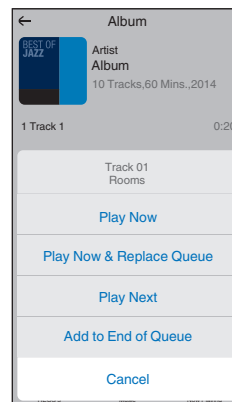

## Listening to the same music in multiple rooms

This system is a true multi-room audio system. You can create one or more HEOS groups to automatically synchronize audio playback between multiple products with HEOS Built-in so that the music playing different rooms is perfectly in sync and always sounds amazing! You can easily add up to 32 products to your system in total. You can group up to 16 individual products to have them play the same song fully synchronized.

### ■ Grouping rooms

- 1** Press and hold your finger on room that is not playing music.
- 2** Drag it into the room that is playing music and lift your finger.
- 3** The two rooms will be grouped together into a single device group and both rooms will be playing the same music in perfect sync.

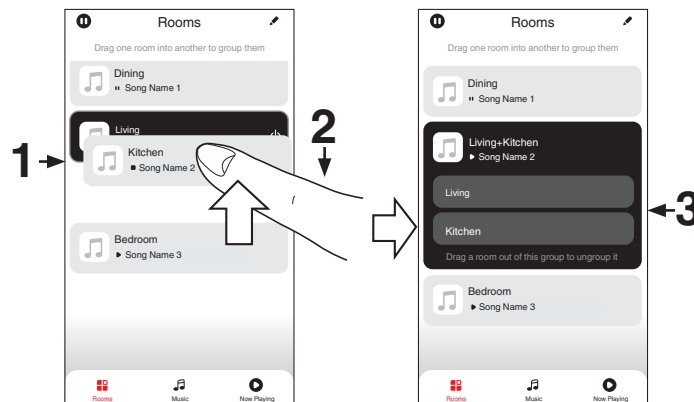

## ■ Ungrouping rooms

- 1 Press and hold your finger on room that you want to remove from the group.
- 2 Drag it out of the group and lift your finger.

### NOTE

- You can not remove the first room that started playing the music before grouping.

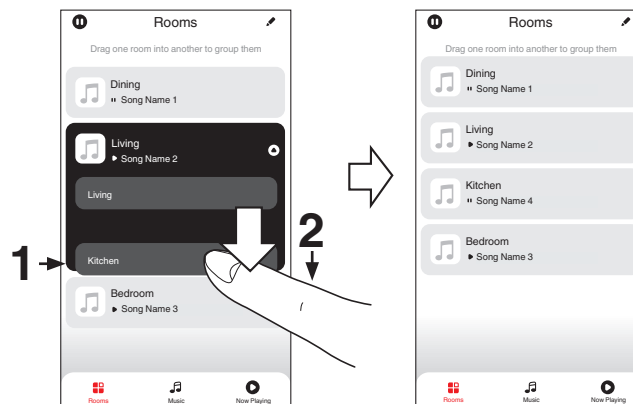

## ■ Grouping all rooms (party mode)

You can easily group 16 rooms together into Party Mode by using a "pinch" gesture.

- 1** Place two fingers on the screen over the list of rooms.
- 2** Quickly pinch your two fingers together and release.
- 3** All of your rooms will be joined together and begin playing the same music in perfect sync.





## ■ Ungrouping all rooms

You can easily ungroup all of your rooms and exit Party Mode by using a "spread" gesture.

- 1 Place two fingers close together on the screen over list of rooms.**
- 2 Quickly spread your two fingers apart from each other and release.**
- 3 All of your rooms will be ungrouped.**

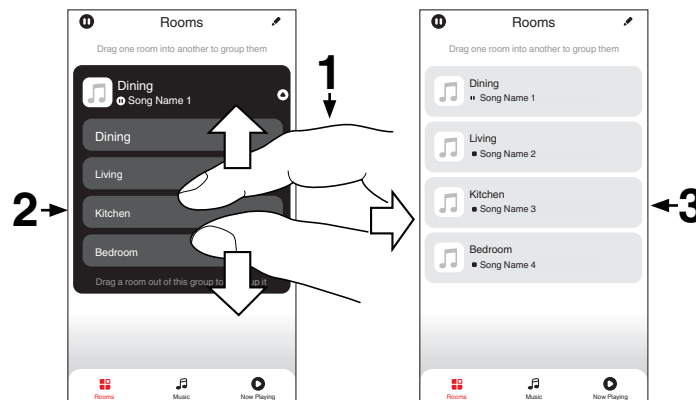

## AirPlay function

Music files stored on your iPhone, iPod touch, iPad or iTunes can be played on this unit via the network.



- Source input will be switched to “HEOS Music” when AirPlay playback is started.
- You can stop AirPlay playback by choosing other input source.
- To see song and artist names together, press STATUS on the remote control unit.
- For information about how to use iTunes, also see the Help for iTunes.
- The screen may differ depending on the OS and software versions.

### This unit supports AirPlay 2.

Sync multiple AirPlay 2 compatible devices/speakers for simultaneous playback.



- This unit supports AirPlay 2 and requires iOS 11.4 or later.

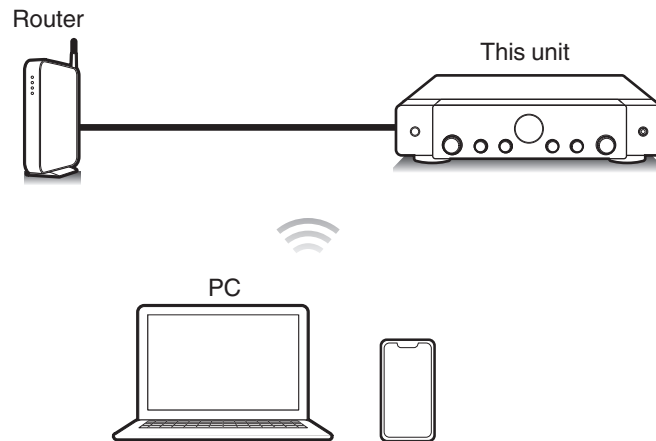

## Playing songs from your iPhone, iPod touch or iPad

If you update your “iPhone/iPod touch/iPad” to iOS 10.0.2 or later, you can stream music stored in your “iPhone/iPod touch/iPad” directly to this unit.

### 1 Connect your iPhone, iPod touch or iPad Wi-Fi to the same network as this unit.

- For details, see your device’s manual.

### 2 Play the song on your iPhone, iPod touch or iPad.

AirPlay icon is displayed on the iPhone, iPod touch or iPad screen.

### 3 Tap the AirPlay icon and select this unit.

[Example] iOS 15

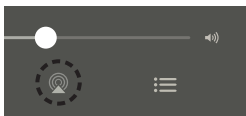

[Example] iOS 10



## Playing iTunes music with this unit

### 1 Install iTunes 10, or later, on a Mac or Windows PC that is connected to the same network as this unit.

### 2 Turn this unit ON.

Set “Network Control” to “Always On” for this unit. (☞ p. 151)

#### NOTE

- When “Network Control” is set to “Always On”, the unit consumes more standby power.

### 3 Start iTunes and click the AirPlay icon to select this unit.

[Example] iTunes



### 4 Choose a song and click play in iTunes.

The music will stream to this unit.



## NOTE

- In playback using the AirPlay function, the sound is output at the iPhone, iPod touch, iPad or iTunes volume setting level. You should turn down the iPhone, iPod touch, iPad or iTunes volume prior to playback and then adjust it to a suitable level.

## Play a song from your iPhone, iPod touch or iPad on multiple synced devices (AirPlay 2)

Songs from an iPhone, iPod touch or iPad operating iOS 11.4 or later can be synced with multiple AirPlay 2 supported devices for simultaneous playback.

### 1 Play the song on your iPhone, iPod touch or iPad.

AirPlay icon is displayed on the iPhone, iPod touch or iPad screen.

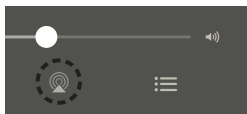

### 2 Tap the AirPlay icon and select this unit.

Displays a list of devices/speakers that can be played back on the same network.

- A circle is displayed to the right of AirPlay 2 compatible devices.

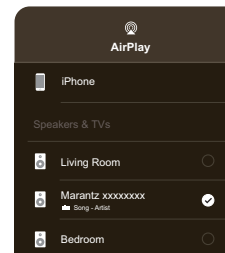

### 3 Tap the devices/speakers you want to use.

- Multiple AirPlay 2 compatible devices can be selected.

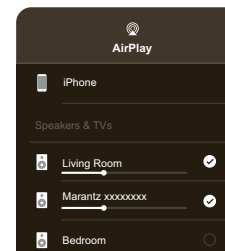

## Spotify Connect function

Spotify is all the music you'll ever need. Millions of songs available instantly. Just search for the music you love, or let Spotify play you something great. Spotify works on your phone, tablet, computer and home speakers. So you'll always have the perfect soundtrack for whatever you're doing. Now you can enjoy Spotify with your free account as well as Premium account.

Use your phone, tablet or computer as a remote control for Spotify.

Go to [www.spotify.com/connect](http://www.spotify.com/connect) to learn how.

The Spotify software is subject to third party licenses found here:

[www.spotify.com/connect/third-party-licenses](http://www.spotify.com/connect/third-party-licenses)

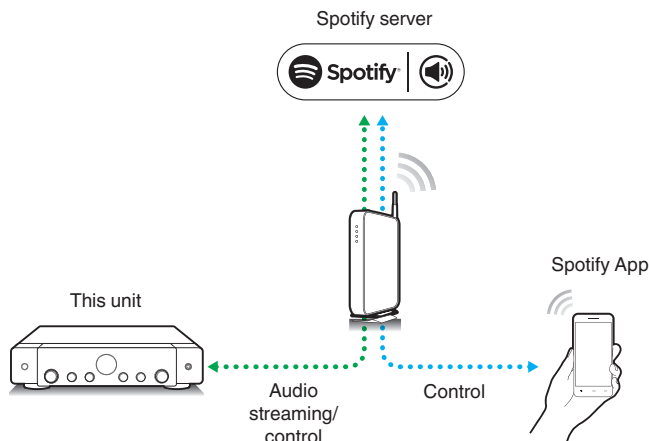

### Playing Spotify music with this unit

Download the "Spotify App" onto your Android or iOS device beforehand.

- 1** Connect the Wi-Fi settings of the iOS or Android device in the same network as this unit.
- 2** Launch the Spotify App.
- 3** Play back the Spotify track.
- 4** Tap the Spotify icon  to select the unit.  
The music will stream to this unit.



## Convenience functions

This section explains how to use convenient functions that can be used for each input source.

These functions can only be set in the MAIN ZONE.

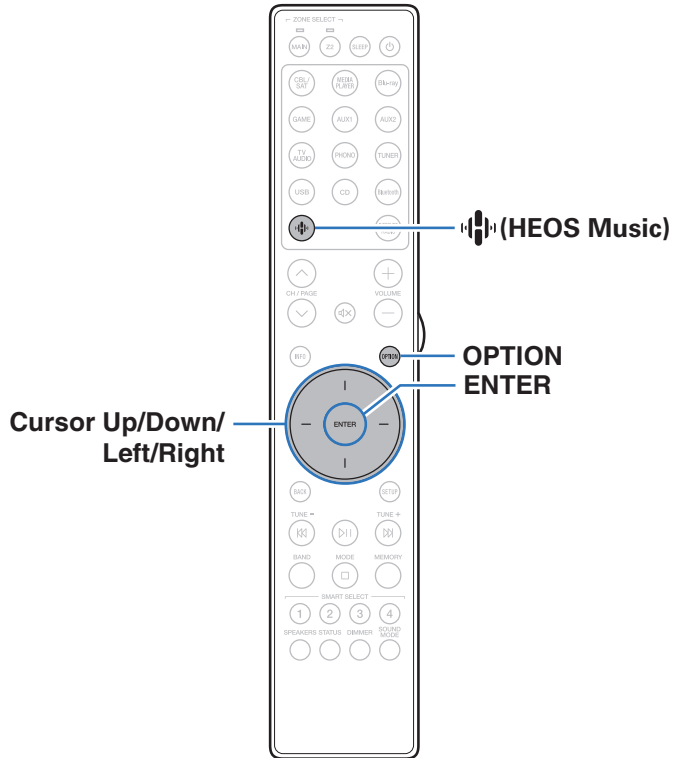

## Playing back HEOS Favorites

When using the HEOS Favorites function for the first time on this unit, create a HEOS Account on the HEOS App or sign in to your account. Once you create or sign into your HEOS Account, you can use the HEOS Favorites feature to save and recall your favorite streaming radio stations using the on-screen user interface on your stereo receiver.

### 1 Press (HEOS Music).

If a playback history is present, the last Internet radio station or song played is played back. Pressing  (HEOS Music) again displays the HEOS Music top menu.

### 2 Use cursor Up/Down to select “HEOS Favorites”, then press ENTER.

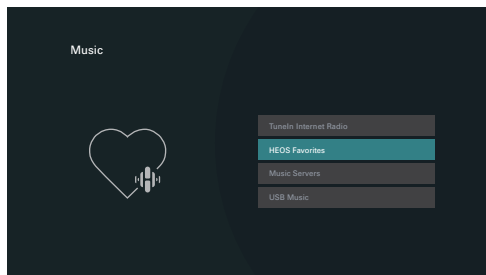

### 3 Browse the content and select something to play.



- “HEOS Favorites - Use HEOS app” is displayed when this unit is not synced with a HEOS Account in the HEOS App.



## Adding to HEOS Favorites

- 1 While content is playing, press **OPTION**.  
The option menu screen is displayed.
- 2 Use cursor **Up/Down** to select “Add to HEOS Favorites”, then press **ENTER**.

## Deleting a HEOS Favorites

- 1 While the HEOS Favorites content list is displayed, use cursor **Up/Down** to select the item you want to remove from HEOS Favorites, then press **OPTION**.
- 2 Use cursor **Up/Down** to select “Remove from HEOS Favorites”, then press **ENTER**.

## Adjust the sound output balance of left and right speakers (Balance)

Adjust the balance in sound output between the left and right speakers.

- 1 **Press OPTION.**  
An option menu screen is displayed.
  - When the input source is “HEOS Music”, an option menu for online music is displayed. Select “Receiver Options...”, then press **ENTER**.
- 2 **Use cursor Up/Down to select “Balance”, then press ENTER.**  
The “Balance” screen is displayed.
- 3 **Use cursor Left/Right to adjust the sound output balance of the left and right speakers then press ENTER.**

---

L 12 – R 12 (Default: 0)

---



- “Balance” setting is stored for each input source.
- This item cannot be set when the sound mode is set to “Direct” or “Pure Direct”.
- You cannot set this when no audio signal is input or in the menu “HDMI Audio Out” is set to “TV”. (p. 131)
- You can also adjust the sound output balance between the left and right speakers by turning the **BALANCE** knob on the main unit.





## Adjust the subwoofer output (Subwoofer)

Adjusts the subwoofer channel volume.

### 1 Press **OPTION**.

An option menu screen is displayed.

- When the input source is "HEOS Music", an option menu for online music is displayed. Select "Receiver Options...", then press ENTER.

### 2 Use cursor **Up/Down** to select "**Subwoofer**", then press **ENTER**.

The "Subwoofer" screen is displayed.

### 3 Use cursor **Left/Right** to turn subwoofer output on and off.

<b>On</b> (Default):	The subwoofer is used.
<b>Off:</b>	The subwoofer is not used.

### 4 Select "**On**" in step 3 and press cursor **Down** to adjust the subwoofer channel volume.

**-12.0 dB – +12.0 dB** (Default : 0.0 dB)



- "Subwoofer" setting is stored for each input source.
- You cannot set this when "Speaker Layout" - "Subwoofer" is set to "No". (🔍 p. 144)
- You cannot set this when no audio signal is input or in the menu "HDMI Audio Out" is set to "TV". (🔍 p. 131)



## Adjusting the tone (Tone)

Adjusts the tonal quality of the sound.

### 1 Press **OPTION**.

An option menu screen is displayed.

- When the input source is "HEOS Music", an option menu for online music is displayed. Select "Receiver Options...", then press **ENTER**.

### 2 Use cursor **Up/Down** to select "Tone", then press **ENTER**.

The "Tone" screen is displayed.

### 3 Select the sound range to be adjusted.

---

**Bass:** Adjust bass.

---

**Treble:** Adjust treble.

---

### 4 Use cursor **Left/Right** to adjust the tone, then press **ENTER**.

---

-6 dB – +6 dB (Default : 0 dB)

---



- "Tone" settings are stored for each input source.
- This cannot be set when the sound mode is set to "Direct" or "Pure Direct".
- You cannot set this when no audio signal is input or in the menu "HDMI Audio Out" is set to "TV". (👉 p. 131)
- You can also adjust the tone by turning the BASS and TREBLE knobs on the main unit.



## Adjusting audio delay (Audio Delay)

Compensates for incorrect timing between video and audio.

### 1 Press OPTION.

An option menu screen is displayed.

- When the input source is "HEOS Music", an option menu for online music is displayed. Select "Receiver Options...", then press ENTER.

### 2 Use cursor Up/Down to select "Audio Delay", then press ENTER.

The "Audio Delay" screen is displayed.

### 3 Use cursor Left/Right to set the auto lip sync function to on/off.

On (Default):	Automatically adjusts the audio processing time to compensate for delays in audio/video timing from TV compatible with Auto Lip Sync.
Off:	Do not adjust automatically.

### 4 Press cursor Down to select "Adjust" if the timing mismatch between the picture and sound need to be corrected manually, then use cursor Left/Right to adjust the timing.

---

0 ms – 500 ms (Default : 0 ms)

---



- "Audio Delay" settings are stored for each input source.
- Automatic correction may not be performed depending on the specifications of your TV even when "Auto Lip Sync" is set to "On".
- You can also finely adjust the delay correction value set by "Auto Lip Sync".



## Displaying your desired video during audio playback (Video Select)

This unit can display video from a different source on TV during audio playback. You can set this for each input source.

### ❑ Supported input sources:

**CD\* / Tuner / HEOS Music / Phono**

\* This cannot be set when any of the HDMI connector is assigned.

### 1 Press OPTION.

An option menu screen is displayed.

- When the input source is “HEOS Music”, an option menu for online music is displayed. Select “Receiver Options...”, then press ENTER.

### 2 Use cursor Up/Down to select “Video Select”, then press ENTER.

The “Video Select” screen is displayed.

### 3 Use cursor Left/Right to select the Video Select mode.

Off (Default):	Disable Video Select mode.
On:	Enable Video Select mode.

### 4 If you selected “On” in step 3, press cursor Down and select “Source”.

### 5 Use cursor Left/Right to select the input source for video you want to play back, then press ENTER.

Last (Default):	Plays the video from the last input source that was played.
CBL/SAT / Media Player / Blu-ray / Game / AUX1 / AUX2 / TV Audio / CD:	Plays the video from the selected input source. *

\* You can select the input source to which the HDMI terminal is assigned.



- “Video Select” settings are stored for each input source.



## Playing the same music in all zones (All Zone Stereo)

You can play back the music being played back in MAIN ZONE simultaneously in ZONE2 (another room).

It is useful when you want to enjoy the same music at the same time in multiple rooms during home party or when you want to play back the same BGM in the entire house.

### 1 Press **OPTION**.

An option menu screen is displayed.

- When the input source is “HEOS Music”, an option menu for online music is displayed. Select “Receiver Options...”, then press **ENTER**.

### 2 Use cursor **Up/Down** to select “All Zone Stereo”, then press **ENTER**.

The “All Zone Stereo” screen is displayed.

### 3 Select “**Start**”, then press **ENTER**.

The input source for ZONE2 is switched to the same input source as for MAIN ZONE, and playback starts in the All Zone Stereo mode.

## ■ Stopping the All Zone Stereo mode

### 1 During playback in All Zone Stereo mode, press **OPTION**.

An option menu screen is displayed.

- When the input source is “HEOS Music”, an option menu for online music is displayed. Select “Receiver Options...”, then press **ENTER**.

### 2 Use cursor **Up/Down** to select “All Zone Stereo”, then press **ENTER**.

### 3 Select “**Stop**”, then press **ENTER**.



- The All Zone Stereo mode is canceled even when the power supply of the MAIN ZONE is turned off.
- In the “All Zone Stereo” mode, only the “Stereo” sound modes can be selected.
- When “HDMI Audio Out” is set to “TV”, the All Zone Stereo mode is not available. (p. 131)
- Save the All Zone Stereo mode playback status to the Smart Select function to enable simple playback in All Zone Stereo mode with a single touch.



## Selecting a sound mode

This unit has a selection of sound modes for you to enjoy: a Direct mode that plays audio exactly as it is recorded on the input source, a Stereo mode that adjusts the bass and treble output and a Pure Direct mode that enhances the quality of the audio that is played in Direct mode.

### Selecting a sound mode

- 1 Press **SOUND MODE** to select a sound mode.

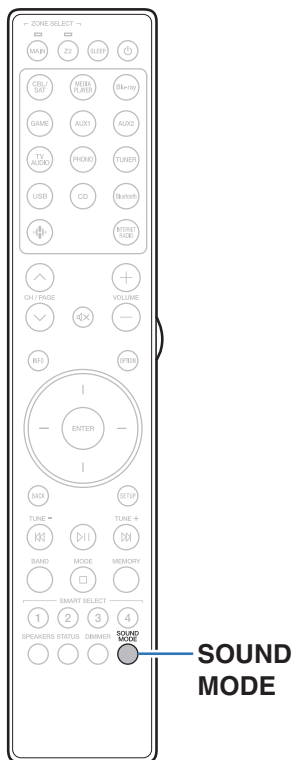

## Description of sound mode types

Sound mode type	Description
Stereo	Plays audio in 2-channel stereo mode. The sound can be adjusted using the M-DAX, Tone (BASS, TREBLE) and Balance functions.
Direct	The signal does not pass through the M-DAX, tone adjustment (BASS and TREBLE) and BALANCE circuitry, resulting in playback of a higher sound quality.
Pure Direct	This mode plays back an even higher quality sound than the "Direct" mode. The following circuits are stopped in order to further improve sound quality. <ul style="list-style-type: none"><li>• Display indicator circuit of the main body (display will go off.)</li></ul>



# HDMI Control function

A recent addition to the HDMI standard is CEC (Consumer Electronics Control), which allows control signals from one device to communicate with another device via the HDMI cable connection.

## Setting procedure

### 1 Enable the HDMI Control function of this unit.

Set "HDMI Control" to "On". (☞ p. 133)

### 2 Turn the power on for all the devices connected by HDMI cable.

### 3 Set the HDMI Control function for all devices connected by HDMI cable.

- Please consult the operating instructions for the connected devices to check the settings.
- Carry out steps 2 and 3 should any of the devices be unplugged.

### 4 Switch the television input to the HDMI input connected to this unit.

### 5 Switch the input source of this unit to check that video from the player connected by HDMI is played back correctly.

### 6 When you turn the TV's power to standby, check that the power of this unit also goes to standby.

#### NOTE

- Some functions may not operate depending on the connected TV or player. Check the owner's manual of each device for details beforehand.





## Sleep timer function

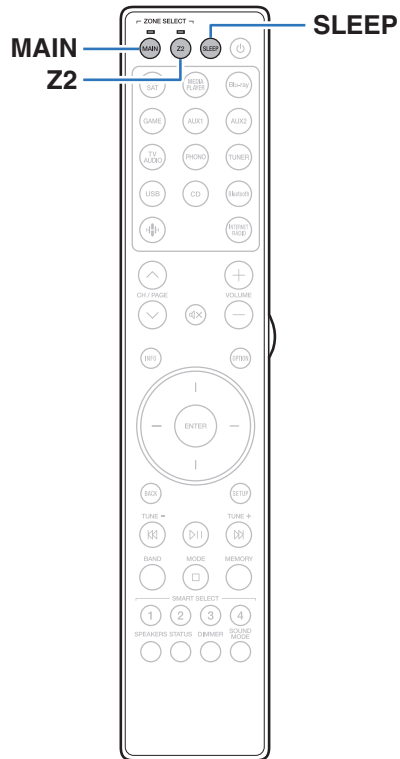

You can have the power automatically switched to standby once a set time has elapsed. This is convenient for viewing and listening while going to sleep. The sleep timer function can be set for each zone.



## Using the sleep timer

### 1 Press MAIN or Z2 to select the operating zone with the remote control.

The indicator for the selected zone is lit.

### 2 Press SLEEP and display the time you want to set.

- The SLEEP indicator lights up on the display and the sleep timer starts.
- You can set the sleep timer in the range from 10 to 120 minutes in steps of 10 minutes.

### ■ Checking the remaining time

Press SLEEP when the sleep timer is in operation.  
The remaining time appears on the display.

### ■ To cancel the sleep timer

Press SLEEP to select “Off”.  
The SLEEP indicator on the display turns off.



- The sleep timer setting is canceled when the unit switches to standby mode.

#### NOTE

- The sleep timer function cannot turn off the power of devices connected to this unit. To turn off the power of those connected devices, set up sleep timers on the connected devices themselves.



## Smart select function

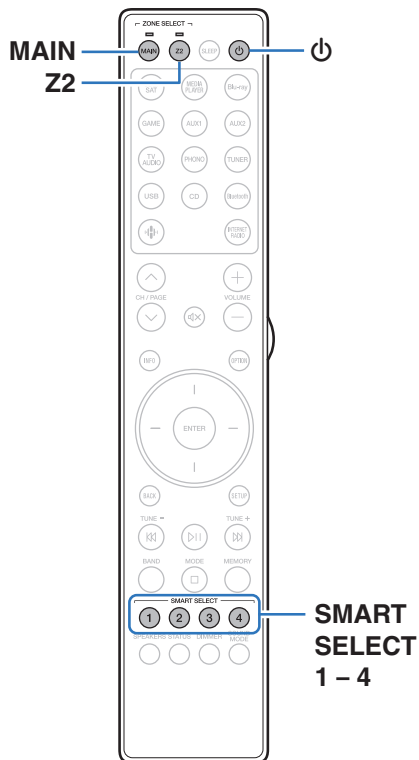

Settings such as the input source, volume level and sound mode can be registered to the SMART SELECT 1 - 4 buttons.

You can simply press one of the registered SMART SELECT buttons in subsequent playbacks to switch to the group of saved settings in a batch. By saving frequently used settings at the SMART SELECT 1 - 4 buttons, you will always be able to easily call up the same playback environment. The Smart Select function can be memorized for each zone.



## Calling up the settings

### 1 Press MAIN or Z2 to select the operating zone with the remote control.

The indicator for the selected zone is lit.

### 2 Press SMART SELECT.

The Smart Select settings registered to the button you pressed are called up.

- The default settings for the input source are as shown below.

#### [MAIN ZONE]

Button	Input source
SMART SELECT 1	CBL/SAT
SMART SELECT 2	Blu-ray
SMART SELECT 3	CD
SMART SELECT 4	HEOS Music

#### [ZONE2]

Button	Input source
SMART SELECT 1	CBL/SAT
SMART SELECT 2	-
SMART SELECT 3	CD
SMART SELECT 4	HEOS Music



- Volume is not registered to Smart Select in the factory default settings. See "Changing the settings" to register volume to Smart Select. (🔍 p. 109)



## Changing the settings

### 1 Set the items below to the settings you want to register.

The following settings from ① to ⑨ can be memorized for MAIN ZONE, and settings ① and ② can be memorized for ZONE2.

- ① Input source (🔗 p. 53)
- ② Volume (🔗 p. 54)
- ③ Sound mode (🔗 p. 102)
- ④ “M-DAX” (🔗 p. 129)
- ⑤ “Adjust the sound output balance of left and right speakers (Balance)” (🔗 p. 96)
- ⑥ “Adjust the subwoofer output (Subwoofer)” (🔗 p. 97)
- ⑦ “Displaying your desired video during audio playback (Video Select)” (🔗 p. 100)
- ⑧ “TV Audio sharing settings” (🔗 p. 110)
- ⑨ “Playing the same music in all zones (All Zone Stereo)” (🔗 p. 101)



- Press and hold SMART SELECT while a radio station is being received is being played back with any of the following sources, the current radio station is memorized.
  - Tuner / Internet Radio Station / Spotify

### 2 Press MAIN or Z2 to select the operating zone with the remote control.

The indicator for the selected zone is lit.

### 3 Press and hold the desired SMART SELECT until “Smart\* Memory” or “Z2 Smart\* Memory” appear on the display.

The current settings will be memorized.

\* is displayed the number for the SMART SELECT button you pressed.

### ■ Changing setting items in Smart Select

You can change the MAIN ZONE Smart Select names displayed on the TV screen or this unit’s display and saved setting items.

See “Smart Select” in the menu for details on how to make these changes. (🔗 p. 162)



## ■ TV Audio sharing settings

You can enjoy the same content as the MAIN ZONE in ZONE2 while playing the content from TV or other playback devices in the MAIN ZONE.

By saving the following settings in advance to Smart Select, you can easily call up the playback environments to be used in the MAIN ZONE and ZONE2 with this function.

### 1 Select the input source to play back in the MAIN ZONE.

### 2 Press Z2 then press POWER with remote control to turn on the power of ZONE2.

### 3 Select “Source” as the input source for ZONE2.

If “Source” is selected as the input source of ZONE2, the input source is changed to mirror that of the MAIN ZONE.

- The factory default setting for the ZONE2 input source is “Source”.
- If you have changed the input source for ZONE2 to a different setting, use the “Marantz AVR Remote” App to change it to “Source”.

① Tap zone control () to select ZONE2.

② Select “Source” as the input source.

### 4 Press and hold the desired SMART SELECT until “Smart\* Memory” appears on the display.



- The ZONE2 input source cannot be set to “Source” from the main unit or remote control unit.



## Panel lock function

To prevent accidental operation of this unit, you can disable operation of the buttons on the front panel.

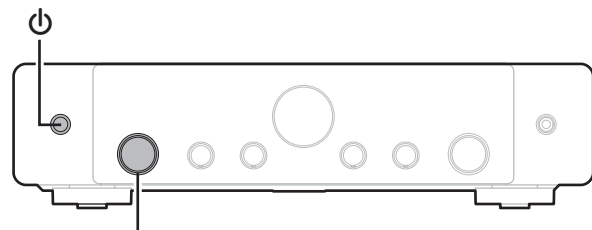

INPUT selector knob

### Disabling all knob operations

- 1** When this unit is turned on, press and hold  $\phi$  on the main unit until “SPECIAL MODE” appears on the display.
- 2** Turn the INPUT selector knob to select “4P/R LOCK”, then press  $\phi$ .
- 3** Turn the INPUT selector knob to select “P/V LOCK ON”, then press  $\phi$  to confirm the setting.  
All knob operations except  $\phi$  are disabled.



## Disabling all knob operations except VOLUME

- 1 When this unit is turned on, press and hold  $\phi$  on the main unit until “SPECIAL MODE” appears on the display.
- 2 Turn the INPUT selector knob to select “4P/R LOCK”, then press  $\phi$ .
- 3 Turn the INPUT selector knob to select “FP LOCK ON”, then press  $\phi$  to confirm the setting.  
All knob operations except  $\phi$  and VOLUME are disabled.

## Canceling the Panel lock function

- 1 When this unit is turned on, press and hold  $\phi$  on the main unit until “SPECIAL MODE” appears on the display.
- 2 Turn the INPUT selector knob to select “4P/R LOCK”, then press  $\phi$ .
- 3 Turn the INPUT selector knob to select “FP LOCK \*OFF”, then press  $\phi$  to confirm the setting.  
(\* The currently set mode.)  
The Panel lock function is canceled.



- Even when the Panel lock function is set, you can operate the unit using the remote control unit.





## Remote lock function

When connecting an IR receiver, enable the Remote lock function. When the function is enabled, you can not perform operations with the remote control unit.

By default, this function is disabled.

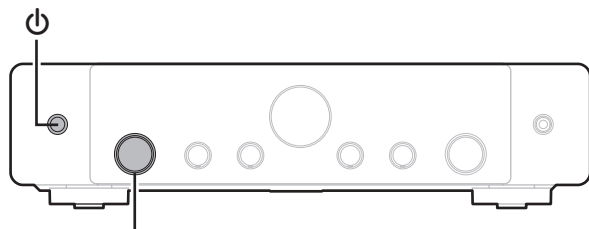



**INPUT selector knob**

### Disabling the sensor function of the remote control unit

- 1** When this unit is turned on, press and hold  $\phi$  on the main unit until “SPECIAL MODE” appears on the display.
- 2** Turn the INPUT selector knob to select “4P/R LOCK”, then press  $\phi$ .
- 3** Turn the INPUT selector knob to select “RC LOCK ON”, then press  $\phi$  to confirm the setting.  
The infrared light receiving function is disabled.



## Enabling the remote sensor function

- 1** When this unit is turned on, press and hold  on the main unit until “SPECIAL MODE” appears on the display.
- 2** Turn the INPUT selector knob to select “4P/R LOCK”, then press .
- 3** Turn the INPUT selector knob to select “RC LOCK \*OFF”, then press  to confirm the setting.

(\* The currently set mode.)

Infrared light receiving function on the main unit is enabled.



## Web control function

You can control and configure this unit from a web control screen on a web browser.

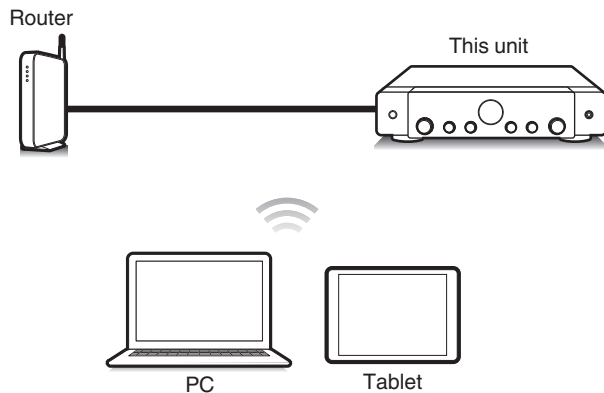

- This unit and the PC or tablet need to be connected correctly to the network in order to use the web control function. (☞ p. 46)
- Depending on the settings of your security-related software, you may not be able to access this unit from your PC. If this is the case, then change the settings of the security-related software.

## Controlling the unit from a web control

The web control screen supports the following functions.

- 1 Setup Menu
- 2 Power ON/OFF for each zone
- 3 MAIN ZONE input source switching

### Web control screen Top menu

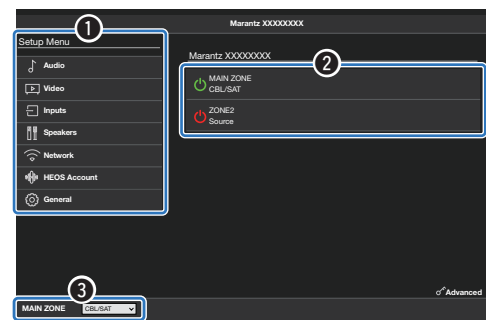

- “Advanced” contains settings for use by custom installers and should not be used at any other time.



- 1 Switch the “Network Control” setting to “Always On”.  
(☞ p. 151)
- 2 Check the IP address of this unit with “Information”.  
(☞ p. 147)

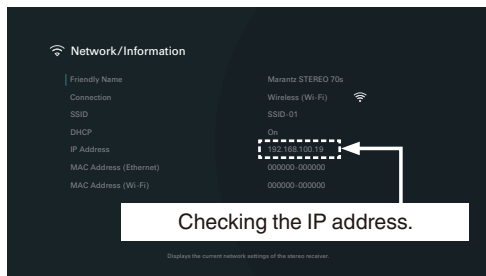

- 3 Open a web browser on a PC or tablet.

- 4 Enter the IP address of this unit in browser's address box.

For example, if the IP address of this unit is “192.168.100.19”, enter “http://192.168.100.19”.

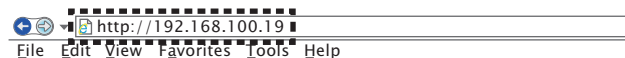

- 5 When the top menu is displayed on the web browser, click on the menu item you want to operate.

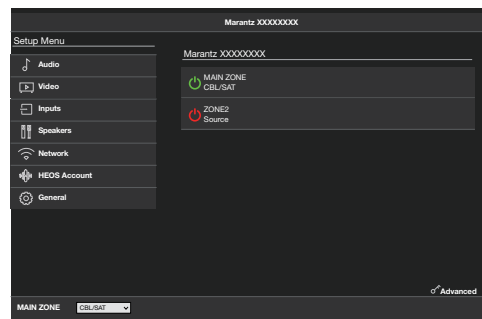

## Playback in ZONE2 (Another room)

---

You can operate this unit to enjoy video and audio in a room (ZONE2) that is different from the room where this unit is placed (MAIN ZONE).

- You can simultaneously play back the same source in both the MAIN ZONE and ZONE2.
- You can also play back separate sources in the MAIN ZONE and ZONE2.

### ■ Connecting ZONE2 (👉 p. 118)

“Connection 1 : Connection using an external amplifier (ZONE2)” (👉 p. 118)

### ■ Playback the source in ZONE2 (👉 p. 119)

“Playing the same source simultaneously in MAIN ZONE and ZONE2 (TV Audio Sharing setting)” (👉 p. 119)

“Playing different sources in MAIN ZONE and ZONE2” (👉 p. 121)

### ■ Adjusting the Volume in ZONE2 (👉 p. 122)

“Adjusting the volume” (👉 p. 122)

“Turning off the sound temporarily (Muting)” (👉 p. 122)



## Connecting ZONE2

### ■ Connection 1 : Connection using an external amplifier (ZONE2)

The audio signals of this unit's ZONE2 audio output connectors are output to the ZONE2 amplifiers and played on these amplifiers.

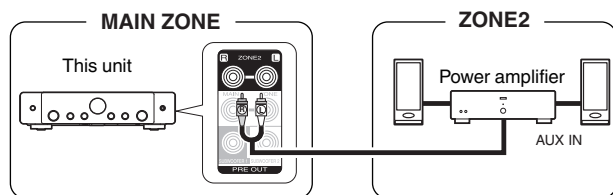

## Playback the source in ZONE2

### ■ Playing the same source simultaneously in MAIN ZONE and ZONE2 (TV Audio Sharing setting)

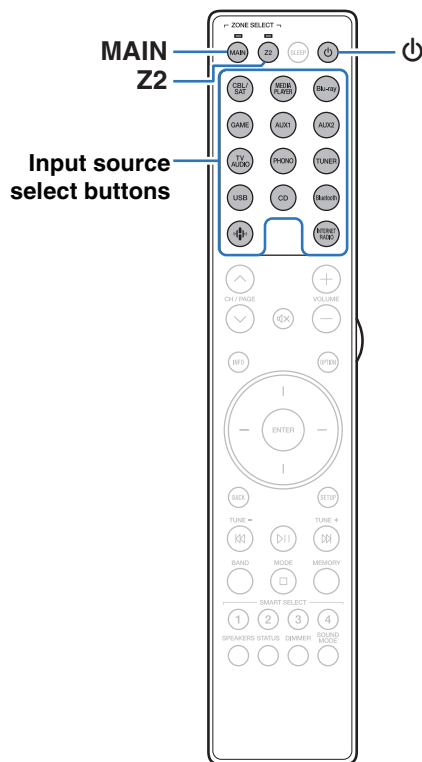

By setting the ZONE2 input source to “Source” in the TV Audio sharing settings of this unit, you can play audio input from a TV via ARC or from a playback device in the MAIN ZONE while enjoying the same content in ZONE2.

- 1 Press MAIN to set the operating zone to MAIN ZONE with the remote control.**  
The MAIN indicator lights.
- 2 Press the input source select button to select the input source to be played.**  
The audio signal of the selected source is output to MAIN ZONE.
- 3 Press Z2 to set the operating zone to ZONE2 with the remote control.**  
The Z2 indicator lights.
- 4 Press POWER to turn on the ZONE2 power.**  
The ZONE2 power indicator on the display lights.



## 5 Select “Source” as the input source for ZONE2.

If “Source” is selected as the input source of ZONE2, the input source is changed to mirror that of the MAIN ZONE.

- The factory default setting for the ZONE2 input source is “Source”.
- If you have changed the input source for ZONE2 to a different setting, use the “Marantz AVR Remote” App to change it to “Source”.

- ① Tap zone control (🏠) to select ZONE2.
- ② Select “Source” as the input source.



- The ZONE2 input source cannot be set to “Source” from the main unit or remote control unit.
- The following audio signals can be played in ZONE2.

Input	Output
	ZONE2
Digital Audio (HDMI)	<input type="radio"/>
Digital Audio (Coaxial/Optical)	<input type="radio"/>
Analog Audio	<input type="radio"/>
USB	<input type="radio"/>
HEOS Music	<input type="radio"/>
TUNER	<input type="radio"/>





## ■ Playing different sources in MAIN ZONE and ZONE2

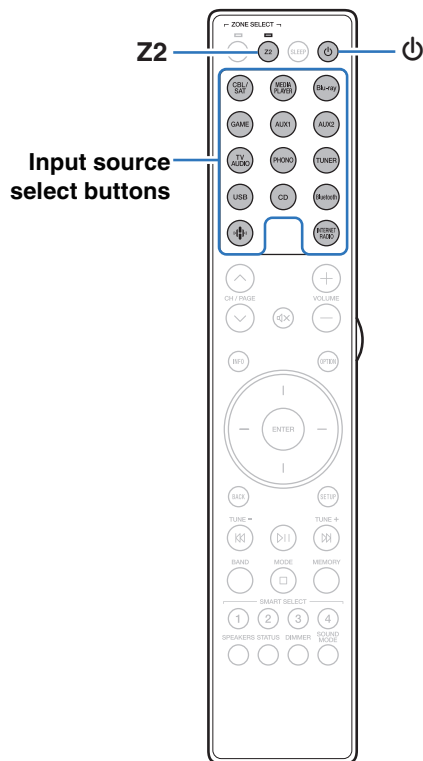

**1** Press Z2 to set the operating zone to ZONE2 with the remote control.

The Z2 indicator lights.

**2** Press POWER  to turn on the ZONE2 power.

The ZONE2 power indicator on the display lights.

**3** Press the input source select button to select the input source to be played.

The audio signal of the selected source is output to ZONE2.

- The following audio signals can be played in ZONE2.

Input	Output
	ZONE2
Digital Audio (HDMI)	
Digital Audio (Coaxial/Optical)	○
Analog Audio	○
USB	○
HEOS Music	○
TUNER	○



## Adjusting the Volume in ZONE2

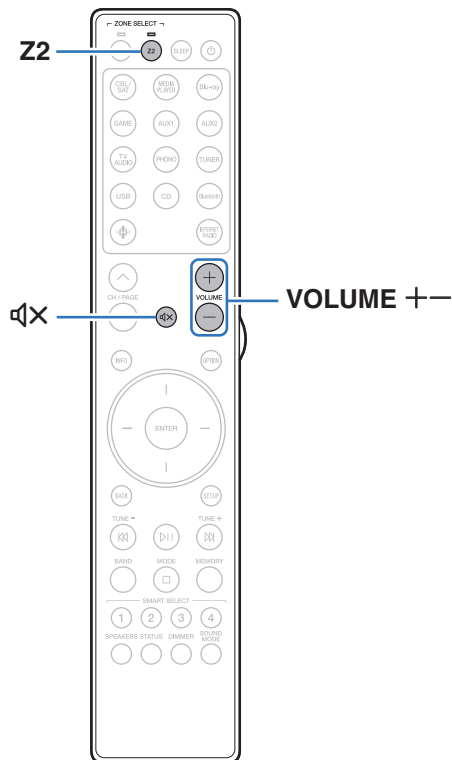

### ■ Adjusting the volume

- 1 Press Z2 to set the operating zone to ZONE2 with the remote control.  
The Z2 indicator lights.
- 2 Use VOLUME +/- to adjust the volume.
  - At time of purchase, “Volume Limit” is set to “70 (-10 dB)”.  
(☞ p. 161)

### ■ Turning off the sound temporarily (Muting)



- 1 Press Z2 to set the operating zone to ZONE2 with the remote control.  
The Z2 indicator lights.
- 2 Press MUTE .
  - To cancel mute, either adjust the sound volume or press MUTE again.





## Menu map

When using menu operations, connect this unit to a TV and operate this unit while viewing the TV.

The recommended settings are configured for this unit by default. You can customize this unit based on your existing system and your preferences.

Setting items	Detailed items	Description	Page
 Audio	<b>M-DAX</b>	Expands the low and high frequency components of compressed audio content such as MP3 files to enable richer audio playback.	129
	<b>Volume</b>	Sets the MAIN ZONE (room where the unit is located) volume setting.	130
 Video	<b>HDMI Setup</b>	Makes settings for HDMI Audio Out, HDMI Pass Through and HDMI Control settings.	131
	<b>HDMI Upscaler</b>	Sets the mode for upscaling 1080p and 4K HDMI content to 8K.	135
	<b>On-Screen Display</b>	Selects the on-screen display user interface preferences.	136
	<b>Screensaver</b>	Sets the screen saver setting.	137
	<b>4K/8K Signal Format</b>	Sets signal format options for your 4K or 8K video equipment.	137
	<b>HDCP Setup</b>	Sets the HDCP version for each HDMI input source.	139

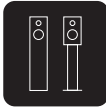

Setting items	Detailed items	Description	Page
 Inputs	<b>Input Assign</b>	Changes input connector assignment and the audio input mode.	140
	<b>Source Rename</b>	Changes the display name for input source.	143
	<b>Hide Sources</b>	Selects source inputs to hide on the user interface and front panel displays.	143
	<b>Source Level</b>	Adjusts the input level for the current source.	143
 Speakers	<b>Speaker Layout</b>	Selects the speaker layout.	144
	<b>Distances</b>	Set distance from listening position to speakers.	145
	<b>Levels</b>	Set the volume of the test tone to be the same at the listening position when it is output from each speaker.	146
	<b>Advanced</b>	Sets the advanced settings for the speakers. (speaker assignment)	146
 Network	<b>Information</b>	Displays network information.	147
	<b>Connection</b>	Configures the network connection.	147
	<b>Settings</b>	Configures the network settings (DHCP and IP address).	149
	<b>Network Control</b>	Enables network communication in standby power mode.	151
	<b>Friendly Name</b>	Edits the name of this unit that is displayed on the network.	151
	<b>Diagnostics</b>	Tests the network connection.	152
	<b>AirPlay</b>	Settings for Apple AirPlay.	153
	<b>Spotify Connect</b>	Toggles access to Spotify Connect.	153
	<b>Wi-Fi and Bluetooth</b>	Toggles power to the Wi-Fi and Bluetooth radios.	154



Setting items	Detailed items	Description	Page
 HEOS	<b>[When the user is signed out of the HEOS account]</b>		
	“_”	A guidance to download the HEOS app.	155
	<b>[When the user is signed in to the HEOS account]</b>		
	Signed in as	Displays your HEOS account.	155



Setting items	Detailed items	Description	Page
 <b>General</b>	<b>Language</b>	Selects the language for the on-screen user interface.	156
	<b>Owner's Manual</b>	Access the online Owner's Manual from your mobile device.	156
	<b>ECO</b>	Configures the ECO Mode and Auto Standby energy-saving functions.	156
	<b>Bluetooth Transmitter</b>	Sets Bluetooth transmitter settings.	160
	<b>ZONE2 Setup</b>	Makes settings for audio playback with ZONE2.	161
	<b>Zone Rename</b>	Changes the display title of each zone to one you prefer.	162
	<b>Smart Select</b>	Changes the Smart Select Name display title to one you prefer.	162
	<b>Front Display</b>	Makes settings related to the display on this unit.	163
	<b>Firmware</b>	Checks for the latest firmware information about updates, updates the firmware.	164
	<b>Information</b>	Shows information about this unit settings, input signals, etc.	166
	<b>Usage Data</b>	Selects whether or not to send anonymous usage data to Marantz.	169
	<b>Save &amp; Load</b>	Save and restore device settings by using a USB memory device.	169
	<b>Setup Lock</b>	Protects settings from inadvertent changes.	170
<b>Reset</b>	Various settings are reset to the factory default values.	170	



Setting items	Detailed items	Description	Page
 Setup Assistant	<b>Begin Setup...</b>	Performs basic installation/connections/settings from the beginning according to the guidance indicated on the TV screen.	Page 8 of the separate manual "Quick Start Guide"
	<b>Language Select</b>	Sets individual setting items according to the guidance displayed on the TV screen.	
	<b>Speaker Setup</b>		
	<b>Network Setup</b>		
	<b>TV Audio Setup</b>		
	<b>Input Setup</b>		
	<b>Mobile Apps</b>		



## Menu operations

- 1 Press MAIN on the remote control unit to set the operating zone to the MAIN ZONE.**  
The MAIN indicator lights.
- 2 Press SETUP.**  
The menu is displayed on the TV screen.
- 3 Use cursor Up/Down/Right to select the menu to be set or operated, then press ENTER.**
- 4 Use cursor Left/Right to change to desired setting.**
- 5 Press ENTER to enter the setting.**
  - To return to the previous item, press BACK.
  - Exiting the menu, press SETUP while the menu is displayed. The menu display disappears.

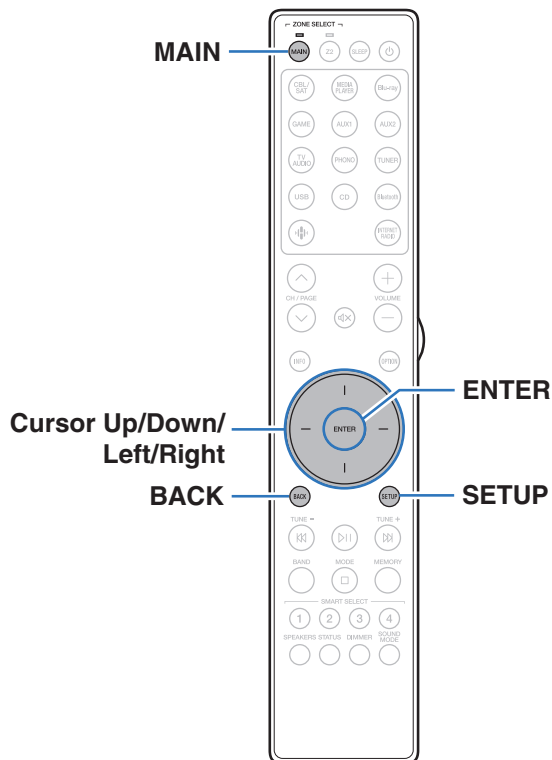



# Audio

Make audio-related settings.

## M-DAX

Compressed audio formats such as MP3, WMA (Windows Media Audio) and MPEG-4 AAC reduce the amount of data by eliminating signal components that are hard for the human ear to hear. The “M-DAX” function generates the signals eliminated upon compression, restoring the sound to conditions near those of the original sound before compression. It also restores the original bass characteristics for a rich and expanded tonal range.

### ■ Mode

<b>High:</b>	Optimized mode for compressed sources with very weak highs (64 kbps and under).
<b>Medium:</b>	Apply suitable bass and treble boost for all compressed sources (96 kbps and under).
<b>Low:</b>	Optimized mode for compressed sources with normal highs (96 kbps and over).
<b>Off</b> (Default):	Do not use “M-DAX”.



- This item can be set with analog signals or PCM signal (Sample Rate = 44.1/48 kHz) is input.
- This cannot be set when the sound mode is set to “Direct” or “Pure Direct”.
- “M-DAX” settings are stored for each input source.



## Volume

Set the MAIN ZONE (room where the unit is located) volume setting.

### ■ Scale

Set how volume is displayed.

**0 - 98**  
(Default): Display in the range 0 (Min) to 98.

**-79.5 dB - 18.0 dB:** Display ---dB (Min), in the range -79.5 dB to 18.0 dB.



- “Scale” settings are reflected in all the zones.

### ■ Limit

Make a setting for maximum volume.

**60 - 80 (-20 dB - 0 dB)**

**Off** (Default)



- The dB value is displayed when the “Scale” setting is “-79.5 dB - 18.0 dB”. (🔍 p. 130)

### ■ Power On Level

Sets the initial volume level when the power is turned on.

**Last**  
(Default): Use the memorized setting from the last session.

**Mute:** Always use the muting on condition when power is turned on.

**1 - 98 (-79 dB - 18 dB) :** The volume is adjusted to the set level.



- The dB value is displayed when the “Scale” setting is “-79.5 dB - 18.0 dB”. (🔍 p. 130)

### ■ Mute Level

Set the amount of attenuation when mute is on.

**Full**  
(Default): The sound is muted entirely.

**-40 dB :** The sound is attenuated by 40 dB down.

**-20 dB :** The sound is attenuated by 20 dB down.



# Video

Make video-related settings.

## HDMI Setup

Make settings for HDMI Audio Out, HDMI Pass Through and HDMI Control settings.

### NOTE

- When “HDMI Pass Through” and “HDMI Control” is set to “On”, it consumes more standby power. (“HDMI Pass Through” (🔗 p. 132), “HDMI Control” (🔗 p. 133)) If you are not using this unit for an extended period, it is recommended that you unplug the power cord from the power outlet.

## ■ HDMI Audio Out

Select HDMI audio output device.

**Stereo Receiver**  
(Default):

Play back through speakers connected to the unit.

**TV:**

Play back through TV connected to the unit.



- When the HDMI Control function is activated, priority is given to the TV audio setting. (🔗 p. 104)
- When the power of this unit is on and “HDMI Audio Out” is set to “TV”, audio is output as 2-channel from the HDMI OUT connector.



## ■ HDMI Pass Through

Selects how this unit will transmit HDMI signals to the HDMI output in standby power mode.

<b>On</b> (Default):	Transmits the selected HDMI input through this unit's HDMI output when this unit is in standby power mode.
<b>Off:</b>	No HDMI signals are transmitted through this unit's HDMI output in standby power mode.

## ■ Pass Through Source

Sets the HDMI connector that inputs HDMI signals when in standby.

<b>Last:</b>	The most recently used input source will go into standby mode.
--------------	--

**CBL/SAT / Media Player / Blu-ray / Game / AUX1 / AUX2 / CD\***  
(Default: CBL/SAT): Pass through the selected input source.

\*"Pass Through Source" can be set when any of the HDMI connectors is assigned to "CD" for the input source in the "Input Assign" setting. (☞ p. 140)



- "Pass Through Source" can be set when "HDMI Control" is set to "On" or "HDMI Pass Through" is set to "On". ("HDMI Pass Through" (☞ p. 132), "HDMI Control" (☞ p. 133))

## ■ RC Source Select

Set whether to allow this unit to be turned on by the input source select button on the remote control when this unit is in standby power mode.

<b>Power On + Source</b> (Default):	The power of this unit is turned on and the input source changes.
<b>Source Select Only:</b>	This unit remains in standby but switches the HDMI input source when you press an input source button. The power display of this unit blinks when the input source select button of the remote control is pressed.



- "RC Source Select" can be set when "HDMI Control" is set to "On" or "HDMI Pass Through" is set to "On". ("HDMI Pass Through" (☞ p. 132), "HDMI Control" (☞ p. 133))



## ■ HDMI Control

You can link operations with devices connected to HDMI and compatible with HDMI Control.

<b>On:</b>	Use HDMI Control function.
<b>Off</b> (Default):	Do not use HDMI Control function.



- Please consult the operating instructions for each connected device to check the settings.
- When “HDMI Control” is set to “On”, the power to this unit can be linked to the TV power and the volume of this unit can be controlled using the TV remote control.
- Refer to “HDMI Control function” for more information about the HDMI Control function. (📖 p. 104)

### NOTE

- If the “HDMI Control” settings have been changed, always reset the power to connected devices after the change.

## ■ ARC

On the TV connected to the HDMI OUT connector, set whether to receive sound from the TV via HDMI.

<b>On:</b>	Use ARC function.
<b>Off</b> (Default):	Do not use ARC function.



- If using this function, use a TV compatible with ARC (Audio Return Channel) and enable the HDMI Control function of the TV.
- When “ARC” is set to “On”, the volume of this unit can be controlled using the TV remote control even when “HDMI Control” is set to “Off” on this unit.

### NOTE

- If the “ARC” settings have been changed, always reset the power to connected devices after the change.
- Only the PCM 2-channel setting can be used to play sound from a TV via the ARC function. Set “PCM 2ch” as the audio format in the TV settings.



## ■ TV Audio Switching

Sets automatic switching to the “TV Audio” input when a TV connected via HDMI sends an appropriate CEC control command to this unit.

<b>On</b> (Default):	Select the “TV Audio” input automatically when receiving a command from the TV.
<b>Off:</b>	Do not select the “TV Audio” input automatically when receiving a command from the TV.



- “TV Audio Switching” can be set when “HDMI Control” is set to “On”.  
( p. 133)

## ■ Power Off Control

Links the power standby of this unit to external devices.

<b>All</b> (Default):	If power to a connected TV is turned off independently of the input source, power to this unit is automatically set to standby.
<b>Video:</b>	With an input source being selected that is assigned “HDMI”, when you turn the power of the TV off, power to this unit is automatically set to standby. (  p. 141)
<b>Off:</b>	This unit does not link with power to a TV.



- “Power Off Control” can be set when “HDMI Control” is set to “On”.  
( p. 133)



## ■ Power Saving

Enables the Power Saving feature of the receiver to reduce energy costs when using the TV's speakers.

This function is activated in the following cases.

- When "TV Audio" is selected as the input source of this unit
- When playing content from a device connected by HDMI

**On:** Use Power Saving feature.

**Off**  
(Default): Do not use Power Saving feature.



- "Power Saving" can be set when "HDMI Control" is set to "On". (🔍 p. 133)

## HDMI Upscaler

Sets the mode for upscaling 1080p and 4K HDMI content to 8K.

**Auto:** Upscale 1080p and 4K HDMI video to 8K based on the TV's capabilities.

**Off**  
(Default): 8K upscaler is disabled.



- This item can be set when "HDMI" is assigned for each input source.
- This function is not effective when the input signal is "x.v.Color", 3D, sYCC601 color, Adobe RGB color, Adobe YCC601 color, computer resolutions, compressed video or HDR.



## On-Screen Display

Select the on-screen display user interface preferences.

### ■ Volume

Sets where to display the volume level.

<b>Bottom</b> (Default):	Display at the bottom.
-----------------------------	------------------------

<b>Top:</b>	Display at the top.
-------------	---------------------

<b>Off:</b>	Turn display off.
-------------	-------------------



- When the master volume display is hard to see when superimposed text (closed captioning) or movie subtitles are present, set to "Top".

### ■ Info

Displays status of operation temporarily when the input source is switched.

<b>On</b> (Default):	Turn display on.
-------------------------	------------------

<b>Off:</b>	Turn display off.
-------------	-------------------

### ■ Now Playing

Sets the display time for the playback display when the input source is "HEOS Music" or "Tuner".

<b>Always On</b> (Default):	Show display continuously.
--------------------------------	----------------------------

<b>Auto Off:</b>	Show display for 30 seconds after operation.
------------------	--





## Screensaver

Select the screen saver setting.

A screen saver is activated if no operation is performed for more than 5 minutes when no video signal is input or when the same screen (e.g. the setup menu) is displayed.

Use cursor Up/Down/Left/Right to clear the screen saver.

<b>On:</b>	Turns screen saver on.
<b>Off</b> (Default):	Turns screen saver off.



- The screen saver is activated in the following cases.
  - When the setup menu is displayed
  - When no video signal is input
  - When the HEOS Music, USB, Bluetooth or Tuner playback screen is displayed

## 4K/8K Signal Format

Set the format of 4K and 8K signal to be played back by this unit when the TV or playback device connected to this unit is HDMI 4K or 8K signal compatible.

### ■ 4K/8K Signal Format

Sets the signal format options for devices connected to each input on this unit.



<b>Standard:</b>	Select if your TV and the source device support 4K 60Hz 4:2:0 8 bit video signals.
<b>Enhanced</b> (Default):	Select if your TV, the source device, and cables support high quality 4K 60Hz 4:4:4 8 bit, 4:2:2 or 4:2:0 10 bit video signals.
<b>8K Enhanced:</b>	Select if your TV, the source device, and cables support high quality 8K 60Hz or 4K 120Hz video signals.



[Relation between the “4K/8K Signal Format” setting and supported resolutions]

Support Resolution	Color Space	Pixel Depth	4K/8K Signal Format		
			Standard	Enhanced	8K Enhanced
4K 24Hz, 4K 30Hz, 4K 25Hz	RGB / YCbCr 4:4:4	8 bit	✓	✓	✓
	YCbCr 4:2:2	10,12 bit	–	✓	✓
		12 bit	✓	✓	✓
4K 60Hz, 4K 50Hz	YCbCr 4:2:0	8 bit	✓	✓	✓
		10,12 bit	–	✓	✓
	RGB / YCbCr 4:4:4	8 bit	–	✓	✓
		10,12 bit	–	–	✓
		12 bit	–	✓	✓
4K 120Hz, 4K 100Hz	YCbCr 4:2:0	8,10,12 bit	–	–	✓
	RGB / YCbCr 4:4:4	8,10 bit	–	–	✓
		12 bit	–	–	✓
8K 24Hz, 8K 30Hz, 8K 25Hz	YCbCr 4:2:0	8,10,12 bit	–	–	✓
	RGB / YCbCr 4:4:4	8,10 bit	–	–	✓
		12 bit	–	–	✓
8K 60Hz, 8K 50Hz	YCbCr 4:2:0	8, 10 bit	–	–	✓



- When setting this to “Enhanced”, we recommend using a “Premium High Speed HDMI Cable” or “Premium High Speed HDMI Cable with Ethernet” that has an “HDMI Premium Certified Cable” label attached to the product package.
- When setting this to “8K Enhanced”, we recommend using a certified “Ultra High Speed HDMI cable”.
- When this setting is “8K Enhanced”, configure the television or playback device settings to match this setting.
- When this setting is “8K Enhanced”, video may not be output correctly depending on the connected playback device or HDMI cable. In this case, change this setting to “Enhanced” or “Standard”.
- “Custom” is displayed for the setting item if our service engineers or custom installers has configured the HDMI signal format for this unit.
- “4K/8K Signal Format” can also be set by the following procedure. However, the menu screen is not displayed. Watch the display while configuring the setting.
  1. Switch to the HDMI input source you want to set.
  2. When this unit is turned on, press and hold  on the main unit until “SPECIAL MODE” appears on the display.
  3. Turn the INPUT selector knob on the main unit to select “5Special Settings”, then press . “4K/8K Format <Enh>” appears on the display.
  4. Turn the SPEAKERS switching knob on the main unit to select the 4K/8K Signal Format setting.
  5. Press  on the main unit to confirm the settings.



## HDCP Setup

Sets the HDCP version for each HDMI input source.

Video may not be output depending on the HDCP version of your player and the TV.

If this issue occurs, use this setting to set one version of HDCP. This may be able to output video.

<b>Auto</b> (Default):	Automatically applies the HDCP version of this unit according to TV.
<b>1.4:</b>	Fixes the HDCP version of this unit to 1.4.
<b>2.3:</b>	Fixes the HDCP version of this unit to 2.3.



- “Custom” is displayed for the setting item if our service engineers or custom installers has configured the HDCP version for this unit.



# Inputs

Perform settings related to input source playback.

You do not have to change the settings to use the unit. Make settings when needed.

## Input Assign

By making connections as indicated by the input sources printed on the audio/video input connectors of this unit, you can just press one of the input source select buttons to easily play back audio or video from a connected device.

Please change the assignment of the HDMI input connector, digital audio input connector and video input connector when connecting an input source that differs from that printed to the audio/video input connectors of this unit.

Sets the audio input mode for each “INPUT MODE” source. “AUTO” is normally recommended for this setting. This automatically detects and plays signal input to this unit prioritized in the following order: HDMI > DIGITAL > ANALOG.

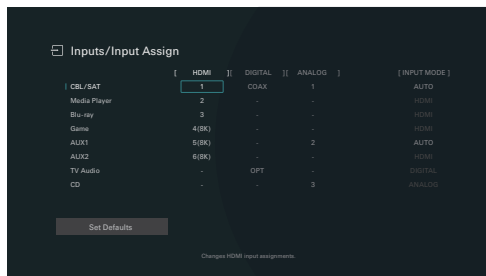

- By default, each item is set as follows.

Input source	Input connector			INPUT MODE
	HDMI	DIGITAL	ANALOG	
CBL/SAT	1	COAX	1	AUTO
Media Player	2	-	-	HDMI
Blu-ray	3	-	-	HDMI
Game	4 (8K)	-	-	HDMI
AUX1	5 (8K)	-	2	AUTO
AUX2	6 (8K)	-	-	HDMI
TV Audio	-	OPT	-	DIGITAL
CD	-	-	3	ANALOG



## TV set top box/satellite users please note

When using the digital audio output on a TV/satellite box:

To play the video signal assigned to "HDMI" combined with the audio signal assigned at "Input Assign" - "DIGITAL", you will also need to select "DIGITAL" in the "INPUT MODE".



- The same input connector can be assigned to multiple input sources. For example, assign the same HDMI input connector to multiple sources to use each input source in combination with analog or digital audio as you prefer. In such cases, set the audio connector for playback in "INPUT MODE".

## HDMI

Set this to change the HDMI input connectors assigned to the input sources.

**1 / 2 / 3 / 4(8K) / 5(8K) / 6(8K):** Assign an HDMI input connector to the selected input source.

- : Do not assign an HDMI input connector to the selected input source.



- When "HDMI Control" or "ARC" is set to "On" in the menu, "HDMI" cannot be assigned to "TV Audio". ("HDMI Control" (p. 133), "ARC" (p. 133))

## DIGITAL

Set this to change the digital audio input connectors assigned to the input sources.

**COAX (Coaxial) / OPT (Optical):** Assign a digital audio input connector to the selected input source.

- : Do not assign a digital audio input connector to the selected input source.

## ANALOG

Set this to change the analog audio input connectors assigned to the input sources.

**1 / 2 / 3:** Assign a analog audio input connector to the selected input source.

- : Do not assign a analog audio input connector to the selected input source.



## ■ INPUT MODE

Set the audio input modes for each input source.  
It is normally recommended to set the audio input mode to "AUTO".

<b>AUTO</b> (Default):	Automatically detect input signal and perform playback.
<b>HDMI:</b>	Play only signals from HDMI input.
<b>DIGITAL:</b>	Play only signals from digital audio input.
<b>ANALOG:</b>	Play only signals from analog audio input.



- If "ARC" is set to "On" and a TV compatible with the ARC is connected via the HDMI OUT connectors, the input mode whose input source is "TV Audio" is fixed to ARC.

## ■ Set Defaults

The "Input Assign" settings are returned to the default settings.



- This unit supports analog audio signals and PCM 2-channel signals. To connect devices with the HDMI and DIGITAL connectors, set "PCM 2ch" as the audio format in the audio device settings.



## Source Rename

- Changes the display name of the input source.  
Once changed, the name is displayed on the display and menu screens of this unit.
- If the device name can be acquired from a connected HDMI device, the display name is changed automatically.  
Use this function to change names as needed when the device you are using differs from the input source on this unit.

**CBL/SAT / Media Player /  
Blu-ray / Game / AUX1 /  
AUX2 / TV Audio / CD /  
Phono:**

Change the display name for input source.

**Set Defaults:**

The “Source Rename” settings are returned to the default settings.



- Up to 16 characters can be input.

## Hide Sources

Remove from the display input sources that are not used.

**Show**

(Default):

Use this source.

**Hide:**

Do not use this source.

## Source Level

This function corrects the playback level of the selected input source's audio input.

Make this setting if there are differences in the input volume levels between the different sources.

**-12 dB – +12 dB** (Default : 0 dB)



- “Source Level” settings are stored for each input source.



# Speakers

Make speaker-related settings.

## Speaker Layout

Select the Left/Right speaker output terminals, whether or not there is a subwoofer, and the low range playback capacity.

### ■ Left/Right

Set the Left/Right speaker output terminals.

### □ Configuration

The Left/Right speakers are fixed at “Yes” because they are required for playback.

Yes (Default)

### □ Connection

Select the Left/Right speaker output terminals.

**Spkr + Pre-out**  
(Default):

Speaker and pre-out outputs are active.

**Pre-out Only:**

Pre-out outputs are active. Speaker outputs are disconnected for enhanced audio quality using only the pre-out terminals.

### ■ Subwoofer

Set the presence of a subwoofer.

**Yes**

(Default):

Use a subwoofer.

**No:**

Select when a subwoofer is not connected.

### ■ Low Pass Filter

Set the low pass filter of the subwoofer channel.

40 Hz / 60 Hz / 80 Hz / 90 Hz / 100 Hz / 110 Hz / 120 Hz / 150 Hz /  
200 Hz / 250 Hz (Default: 80 Hz)



- This item cannot be set when “Subwoofer” is set to “No”.





## Distances

Set distance from listening position to speakers.

Measure beforehand the distance from the listening position to each speaker.

### ■ Unit

Set the unit of distance.

---

**Feet** (Default)

---

**Meters**

---

### ■ Step

Set the minimum variable width of the distance.

---

**1 ft / 0.1 ft** (Default: 1 ft)

---

**0.1 m / 0.01 m**

---

### ■ Set the distance

---

**0.0 ft – 59.1 ft / 0.00 m – 18.00 m** (Default: 11.8 ft (3.60 m))

---



- The subwoofer cannot be set when the “Speaker Layout” - “Subwoofer” is set to “No”. (👉 p. 144)
- Set the difference in the distance between the speakers to less than 19.7 ft (6.00 m).

### ■ Set Defaults

The “Distances” settings are returned to the default settings.



## Levels

Set the volume of the test tone to be the same at the listening position when it is output from each speaker.

### ■ Test Tone Start

A test tone is output from the selected speaker.

While listening to the test tone, adjust the volume output from the selected speaker.

**-12.0 dB – +12.0 dB** (Default : 0.0 dB)



- The set “Levels” are reflected in all sound modes.
- If you wish to adjust the left and right balance for each input source, carry out the settings in “Balance”. (👉 p. 96)
- When headphones are connected to the PHONES connector on this unit, you cannot set “Levels”.

### ■ Set Defaults

The “Levels” settings are returned to the default settings.

## Advanced

### ■ Speaker Select

#### □ Speaker

Set the speaker A/B to use.

<b>A</b> (Default):	Speaker A is used.
<b>B :</b>	Speaker B is used.
<b>A+B :</b>	Both speaker A+B are used.



- You can also select speakers by turning SPEAKERS knob on the main unit.



# Network

To use this unit by connecting it to a home network (LAN), you must configure network settings.

If you set up your home network (LAN) via DHCP, set “DHCP” to “On”. (Use the default setting.) This allows this unit to use your home network (LAN). When assigning an IP address to each device manually, you need to assign an IP address to this unit using the “IP Address” settings, and enter information about your home network (LAN) such as the gateway address and subnet mask, etc.

## Information

Display network information.

---

**Friendly Name / Connection / SSID / DHCP / IP Address /  
MAC Address (Ethernet) / MAC Address (Wi-Fi) /  
Wi-Fi signal strength**

---

## Connection

Choose whether to connect the home network to a wireless LAN or a wired LAN.

When connecting to the network using wired LAN, select “Wired (Ethernet)” after connecting a LAN cable.

When connecting to the network using wireless LAN, select “Wireless (Wi-Fi)” and configure the “Wi-Fi Setup”. (🔧 p. 148)

### ■ Connect Using

Select the method for connecting to the home network (LAN).

<b>Wired (Ethernet):</b>	Use a LAN cable to connect to a network.
<b>Wireless (Wi-Fi) (Default):</b>	Use the wireless LAN (Wi-Fi) function to connect to a network.



- “Wired (Ethernet)” is set when “Wi-Fi” is set to “Disabled”. (🔧 p. 154)



## Wi-Fi Setup

Connect to a wireless LAN (Wi-Fi) router.

The router can be connected in the following ways. Select the connection method to suit your home environment.

### ■ Scan Networks

Select the network you wish to connect to from the list of possible networks shown on the TV screen.

1. Select the network you wish to connect to from the list of wireless networks.

Select "Rescan" if the network cannot be found.

2. Enter your password and select "OK".

### ■ Use iOS Device

Use your iOS device (iPhone/iPod/iPad) to connect to the network. By connecting your iOS device to this unit using Wi-Fi, the unit can be automatically connected to the same network as your device.

1. Select "Use iOS Device" on the TV screen.
2. Check that your iOS device is connected to the wireless LAN (Wi-Fi) router and select "Marantz STEREO 70s" from "SET UP NEW AIRPLAY SPEAKER..." at the bottom of the Wi-Fi configuration screen of your iOS device.
3. Tap "Next" on the screen of the iOS device.



- The iOS device firmware version needs to support iOS 10.0.2 or later.

### ■ WPS Router

Use a WPS-compatible router to connect using the push button method.

1. Select "Push Button" on the TV screen.
2. Switch to the WPS mode by pressing the WPS button of the router you wish to connect to.
  - The time for pressing the button varies depending on the router.
3. Select "Connect" on the TV screen within 2 minutes.





## ■ DHCP

Selects how to connect to the network.

<b>On</b> (Default):	Configure the network settings automatically from your router.
<b>Off:</b>	Configure the network settings manually.

## ■ IP Address

Set the IP address within the ranges shown below.

- The Network Audio function cannot be used if other IP addresses are set.

CLASS A: 10.0.0.1 - 10.255.255.254

CLASS B: 172.16.0.1 - 172.31.255.254

CLASS C: 192.168.0.1 - 192.168.255.254

## ■ Subnet Mask

When connecting an xDSL modem or connector adapter directly to this unit, input the subnet mask indicated in the documentation supplied by your provider. Normally input "255.255.255.0".

## ■ Default Gateway

When connected to a gateway (router), input its IP address.

## ■ DNS

Enter the DNS address indicated in the documentation supplied by your provider.



- If you cannot connect to the Internet, recheck the connections and settings. (☞ p. 46)
- If you do not understand about Internet connection, contact your ISP (Internet Service Provider) or the store from which you purchased your computer.



## Network Control

Enables network communication in standby power mode.

**Off In Standby:** Suspend network function during standby.

**Always On (Default):** Network is on during standby. Main unit operable with a network compatible controller.



- When using the web control function, Marantz AVR Remote App or HEOS App, use with the “Network Control” setting set to “Always On”.

### NOTE

- When “Network Control” is set to “Always On”, the unit consumes more standby power.

## Friendly Name

The Friendly Name is the name of this unit displayed on the network. You can change the Friendly Name according to your preferences.

### ■ Name

Selects Friendly Name from the list.

When you select “Other”, you can change the Friendly Name according to your preferences.

**Home Theater / Living Room / Family Room / Guest Room / Kitchen / Dining Room / Master Bedroom / Bedroom / Den / Office / Other**



- Up to 30 characters can be input.
- The default Friendly Name on first use is “Marantz STEREO 70s”.

### ■ Set Defaults

Restores Friendly Name, which you had changed, to the default setting.



## Diagnostics

Used to check the network connection.

### ■ Physical Connection

Checks the physical LAN port connection.

---

**OK**

**Error:**

The LAN cable is not connected. Check the connection.

---



- When connected using a wireless LAN, "Connection Wireless (Wi-Fi)" will be displayed.

### ■ Router Access

Checks the connection from this unit to the router.

---

**OK**

**Error:**

Failed to communicate with the router. Check the router settings.

---

### ■ Internet Access

Checks whether this unit has access to the Internet (WAN).

---

**OK**

**Error:**

Failed to connect to the Internet. Check the Internet connection environment or router settings.

---





## AirPlay

Settings for Apple AirPlay.

### ■ AirPlay Name

Displays the name which identifies this unit on Apple devices.



- If you registered this unit to the Apple Home app, use the app to change the name.

### ■ AirPlay

Enables/disables the Apple AirPlay.

<b>On</b> (Default):	Enables Apple AirPlay.
-------------------------	------------------------

<b>Off:</b>	Disables Apple AirPlay.
-------------	-------------------------

## Spotify Connect

Toggles access to Spotify Connect.

<b>On</b> (Default):	Enables Spotify Connect.
-------------------------	--------------------------

<b>Off:</b>	Disables Spotify Connect.
-------------	---------------------------



## Wi-Fi and Bluetooth

Enables/disables the Wi-Fi and Bluetooth radios.

### ■ Wi-Fi

The Wi-Fi function can be stopped to prevent noise that affects the sound quality. Using a wired LAN to connect this unit to the network enables playback with a high sound quality.

---

<b>Enabled</b> (Default):	Enables the Wi-Fi function.
------------------------------	-----------------------------

---

<b>Disabled:</b>	Disables the Wi-Fi function.
------------------	------------------------------

---

### ■ Bluetooth

Stopping Bluetooth receiver and transmitter functions reduces a source of noise that affects sound quality, enabling higher sound quality playback.

---

<b>Enabled</b> (Default):	Enables the Bluetooth function.
------------------------------	---------------------------------

---

<b>Disabled:</b>	Disables the Bluetooth function.
------------------	----------------------------------

---



# HEOS

HEOS Account is needed in order to use HEOS Favorites.  
The menu displayed differs depending on the status of the HEOS Account.

## You have not signed in

A QR code is displayed on the TV screen.  
Scan the QR code with your mobile device and download the HEOS App.  
After creating or signing in to your HEOS Account in the HEOS App, you can save and call up your favorite streaming music services from this unit's screen. (👉 p. 95)  
See "Getting the HEOS App" (👉 p. 81) for details about the HEOS App.



- This unit's HEOS Account setting information is synced with the HEOS App. Change settings and sign out of your account through the HEOS App.

## You have already signed in

### ■ Signed in as

The currently signed in HEOS Account is displayed.



- This unit automatically syncs when you change your account settings or sign out through the HEOS App. To switch HEOS accounts, play back music from an HEOS App signed in to the account you wish to sync to this unit. The "HEOS Account" switches automatically.



## General

Make various other settings.

### Language

Set the language for display the menu on the TV screen.

**English / Français / Español** (Default: English)



- “Language” can also be set up by the following operation. However, the menu screen is not displayed. Watch the display while configuring the settings.
  1. When this unit is turned on, press and hold **⏻** on the main unit until “SPECIAL MODE” appears on the display.
  2. Turn the INPUT selector knob on the main unit to select “5Special Settings”, then press **⏻**.  
“4K/8K Format <Enh>” appears on the display.
  3. Turn the INPUT selector knob on the main unit to select “GUI Language ENGLISH”.
  4. Turn the SPEAKERS switching knob on the main unit to select the language.
  5. Press **⏻** on the main unit to confirm the settings.

### Owner's Manual

Shows URL and QR code to access the online Owner's Manual from your mobile device.

### ECO

Configure the ECO Mode and auto standby mode settings.

#### ■ ECO Mode

This mode can reduce the power consumption and heat generation of this unit when power on.

This is done by reducing the power supply line to the power amplifier, in turn the maximum power output.



<b>On:</b>	Power savings are always active, regardless of volume or input signal.	
	Gives you the best balance between power savings and maximum power output: For low volume levels, the power savings are active. If you increase the volume level, the power savings are switched off automatically, so you can enjoy maximum output power without distortion.	
<b>Auto</b> (Default):	If the volume is set to a high level but no input signal is detected for more than 2 minutes, this unit will enable power savings. When an input signal is detected again or the input source is changed, this unit will automatically turn off power savings again at high volume levels.	 <ul style="list-style-type: none"><li>• When the unit is switching between the different power saving states in “ECO Mode: Auto”, you may notice a click noise from the inside of this unit, this is normal.</li><li>• If content is paused for more than 2 minutes and playback is resumed from the same source at these high volume levels, there may be short delay before maximum power is restored.</li><li>• “ECO Mode” cannot be set when speaker impedance is set to 4 Ω/ohms. (👉 p. 28)</li></ul>
<b>Off:</b>	No power savings.	



## ■ Power On Default

Set the mode to ECO when the power is on.

<b>Last (Default):</b>	The ECO Mode will be set to the previous setting before the power was switched off.
<b>On:</b>	When power is turned on, the mode will always be switched to the ECO Mode in "On".
<b>Auto:</b>	When power is turned on, the mode will always be switched to the ECO Mode in "Auto".
<b>Off:</b>	When power is turned on, the mode will always be switched to the ECO Mode in "Off".

## ■ On Screen Display

Display the power consumption of this unit using a meter on the TV screen.

<b>Always On:</b>	Always display the meter on the TV screen.
<b>Auto (Default):</b>	Display the meter when changing the mode or volume.
<b>Off:</b>	Do not display the meter.



## ■ Auto Standby

Set so the unit power automatically switches to standby.

### □ MAIN ZONE

Sets the time for switching to auto standby when there are no audio or video signals input into this unit.

Before the unit enters standby mode, "Auto Standby" is displayed on the unit display and the menu screen.

<b>60 min:</b>	The unit goes into standby after 60 minutes.
<b>30 min:</b>	The unit goes into standby after 30 minutes.
<b>15 min:</b>	The unit goes into standby after 15 minutes.
<b>Off</b> (Default):	The unit does not go into standby automatically.

### □ ZONE2

When there are no operations for a certain period of time as set here, the power is automatically shut off even if there is audio or video input.

<b>8 hours:</b>	Switches ZONE2 the standby state after about 8 hours.
<b>4 hours:</b>	Switches ZONE2 to the standby state after about 4 hours.
<b>2 hours:</b>	Switches ZONE2 to the standby state after about 2 hours.
<b>Off</b> (Default):	Does not automatically switch ZONE2 to the standby state.



## Bluetooth Transmitter

Sets this unit's Bluetooth transmitter.

Set to use Bluetooth headphones to listen to audio playing in the MAIN ZONE.

### Transmitter

Enables or disables the Bluetooth transmitter.

<b>On:</b>	Enables the Bluetooth transmitter feature.
<b>Off (Default):</b>	Disables the Bluetooth transmitter feature.

### Output Mode

Selects the audio output method.

<b>Bluetooth + Speakers (Default):</b>	Audio is output to Bluetooth headphones and main zone speakers.
<b>Bluetooth Only:</b>	Audio is output to Bluetooth headphones only.

### Connected device

Displays the Bluetooth device connected to this unit.

### Device List

- Available devices are displayed in the list once you start pairing mode on the Bluetooth headphones you want to connect. Select your Bluetooth headphones from the list to pair them.
- This unit can only pair with one Bluetooth headphone at a time. However, up to 8 Bluetooth headphones can be registered. Switch between registered devices from Device List in the "Bluetooth Transmitter" setup menu.
- To remove a saved Bluetooth device from the list, use the cursor Up/Down buttons to select it, then press the OPTION button and select "Forget This Device".



- "Output Mode" can also be set from "Bluetooth Transmitter" in the option menu.
- A2DP profile-compatible Bluetooth speakers can be connected following the same steps used to connect Bluetooth headphones.

#### NOTE

- Bluetooth transmitter and Bluetooth receiver function cannot be used at the same time. Settings in this menu are not available when listening to music on a Bluetooth device in any zone.
- Even when "Transmitter" is set to "On", press Bluetooth on the remote control to select the "Bluetooth" source and enable the Bluetooth receiver function. To listen to music stored on Bluetooth devices such as smartphones on this unit, press Bluetooth on the remote control to switch the input source to Bluetooth, then reconnect the Bluetooth device.
- Menu settings for Bluetooth Transmitter are not available when this unit is grouped within the HEOS App.





## ZONE2 Setup

Makes settings for audio playback with ZONE2.



- Values set for "Volume Limit" and "Power On Volume" are displayed according to the setting specified for the volume "Scale". (🔗 p. 130)

### ■ Volume Level

Set the volume output level.

<b>Variable</b> (Default):	Volume can be adjusted.
<b>1 – 98</b> <b>(-79 dB – 18 dB):</b>	Volume is fixed at the desired level. The volume cannot be adjusting using the remote control unit.



- The dB value is displayed when the "Scale" setting is "-79.5 dB – 18.0 dB". (🔗 p. 130)

### ■ Volume Limit

Make a setting for maximum volume.

**60 (-20 dB) / 70 (-10 dB) / 80 (0 dB)**  
(Default : 70 (-10 dB))

**Off:** Do not set a maximum volume.



- This can be set when "Volume Level" is set to "Variable". (🔗 p. 161)
- The dB value is displayed when the "Scale" setting is "-79.5 dB - 18.0 dB". (🔗 p. 130)

### ■ Power On Volume

Define the volume setting that is active when the power is turned on.

<b>Last</b> (Default):	Use the memorized setting from the last session.
<b>Mute:</b>	Always mute when power is turned on.
<b>1 – 98</b> <b>(-79 dB – 18 dB):</b>	The volume is adjusted to the set level.



- This can be set when "Volume Level" is set to "Variable". (🔗 p. 161)
- The dB value is displayed when the "Scale" setting is "-79.5 dB - 18.0 dB". (🔗 p. 130)



## Zone Rename

Change the display title of each zone to one you prefer.

### MAIN ZONE / ZONE2

#### Set Defaults:

The default setting is restored for the edited zone name.



- Up to 10 characters can be input.

## Smart Select

Sets the “Smart Select” parameters and display name.

### ■ Name

Change the Name that appears on the TV screen to one you prefer.



- Up to 16 characters can be input.



## ■ Input Source/Master Volume/Sound Mode/ Balance/Subwoofer/M-DAX/Playback Content/All Zone Stereo/TV Audio Sharing

**Enabled**  
(Default):

The current settings are registered when Smart Select is registered. In addition, when Smart Select is called up, the content of the registered settings is called up.

**Disabled:**

Settings are not registered when Smart Select is registered. In addition, when Smart Select is called up, the content of the registered settings is not called up.



- “Smart Select” can be set for each Smart Select.
- When “Input Source” is “Disabled”, Video Select information is not registered/called up either.

## Front Display

Makes settings related to the display on this unit.

### ■ Brightness

Adjust the display brightness of this unit.

**Bright**  
(Default): Normal display brightness.

**Dim:** Reduced display brightness.

**Dark:** Very low display brightness.

**Off:** Turns the display off.



## Firmware

Checks for the latest firmware information about updates, updates the firmware.

### ■ Check for Update

Check for firmware updates.

The firmware can be updated if a firmware update has been released.

<b>Update Now:</b>	Execute the update process. When the update starts, the menu screen is shut down. During the update, the progress is shown on the display.
<b>Update Later:</b>	Update later.



- This unit automatically retries updating if updating fails. If an update still cannot be performed, an "Update Error" message appears in the display. See "Troubleshooting" – "Update error messages" for information on update error messages. (🔍 p. 193)  
Check the conditions according to the message and try the update again.
- This menu cannot be selected when "Allow Update" is set to "Off".

### ■ Auto-Update

Turns on Automatic Updates so that feature updates are automatically downloaded and installed when this unit is in standby mode.

#### ☐ Auto-Update

This unit will automatically update to the newest firmware when in standby mode.

---

**On:** Turns on Automatic Updates.

---

**Off (Default):** Turns off Automatic Updates.

---

#### ☐ Time Zone

Change the time zone.

Set the time zone that matches the area where you live.



- This menu cannot be selected when "Allow Update" is set to "Off".



## ■ Allow Update

Enable or disable updates for this unit.

---

**On**  
(Default): Enables this unit to receive updates.

---

**Off:** Prevents this unit from receiving update.

---



- This setting causes Incompatibilities between this unit and HEOS App.



### Notes concerning use of “Update”

- In order to use these functions, you must have the correct system requirements and settings for an Internet connection. (👉 p. 46)
- Do not turn off the power until updating is completed.
- Approximately 1 hour is required for the updating procedure to be completed.
- Once updating starts, normal operations on this unit cannot be performed until updating is completed. Furthermore, there may be cases where backup data is reset for the parameters, etc., set on this unit.
- If the update fails, press and hold the  $\phi$  on the main unit for more than 5 seconds, or remove and re-insert the power cord. After about 1 minute, “Please wait” appears on the display and update restarts. If the error continues, check the network environment.

## Information

Show information about this unit settings, input signals, etc.

### ■ Audio

Show the audio information for MAIN ZONE.

<b>Sound Mode:</b>	The currently set sound mode.
<b>Input Signal:</b>	The input signal type.
<b>Sample Rate:</b>	The input signal's sampling frequency.



## ■ Video

Show the HDMI input/output signals and HDMI TV information for MAIN ZONE.

### HDMI Signal Info.

**Resolution / HDR / Color Space / Pixel Depth / ALLM / QFT / FRL Rate**

### TV Info.

**Interface / HDR / Resolutions / Enhanced Features / Max FRL Rate**



- A or B may be displayed at the end of resolution. A represents uncompressed video and B represents compressed video.
- Refer to “About HDMI” for more information about ALLM, QFT and FRL. (👉 p. 198)

## ■ ZONE

Show information about current settings.

### MAIN ZONE:

This item shows information about settings for MAIN ZONE. The information displayed differs according to the input source.

### ZONE2:

This item shows information about settings for ZONE2.

## ■ Firmware

### Version:

Displays information for the current firmware.



## ■ Notifications

Displays and sets notifications.

Also, sets whether or not to display the notification when the power is turned on.

### Notification Alerts

**On**  
(Default): Notification messages are displayed.

**Off:** Notification messages are not displayed.



- Pressing INFO on the remote control switches the display to show information such as the input source name, the volume, the sound mode name, the video input/output signals, and other information. The FRL Rate is displayed when the "4K/8K Signal Format" setting of this unit is "8K Enhanced" and the connected TV supports FRL transmission mode.

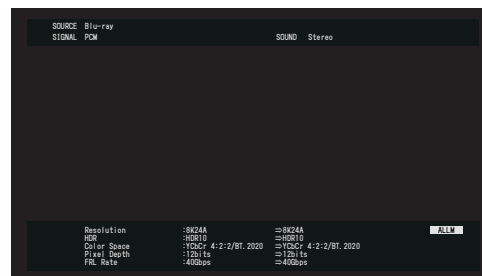
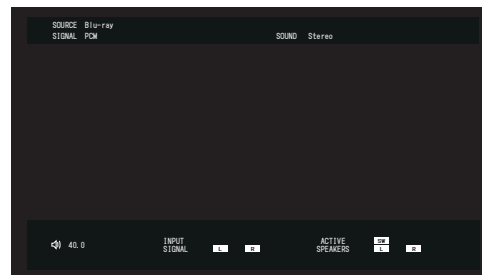



## Usage Data

To help us improve our products and customer service, Marantz collects anonymous information about how you use this unit (such as frequently used input sources and sound modes and speaker settings). Marantz will never provide any information we collect to third parties.

<b>Yes:</b>	Provide information on the operating status of this unit.
<b>No:</b>	Do not provide information on the operating status of this unit.

## Save & Load

Save and restore device settings by using a USB memory device.



- Use a USB memory device that has at least 128 MB of free space and is formatted to FAT32. Data may not Save/Load correctly to some USB memory devices.
- It may take up to 10 minutes for data to Save/Load. Do not turn off the power until the process is complete.

### ■ Save Configuration

Current unit settings are stored on the USB memory device.

When the settings are saved correctly, “Saved” appears on the display and the file “config.avr” is created on the USB memory device.



- Do not change the file name of the created file. Doing so will prevent the file from being recognized as a settings file when restoring.

### ■ Load Configuration

Settings saved on the USB memory device are restored.

When the saved settings are restored correctly, “Loaded” appears on the display and the unit automatically restarts.



## Setup Lock

Protect settings from inadvertent changes.

### ■ Lock

**On:** Turn protection on.

**Off**  
(Default): Turn protection off.



- When cancelling the setting, set “Lock” to “Off”.

#### NOTE

- When “Lock” is set to “On”, no setting items are displayed except for “Setup Lock”.

## Reset

Returns settings to the factory default.

Initialization can be performed for all unit settings or for Network settings only.

### ■ All Settings

All settings are reset to the factory default values.

### ■ Network Settings

Only network settings are reset to the factory default values.



- Before returning the settings to the default settings, use the “Save & Load” function from the menu to save and restore the details of various settings configured on the unit. (🔗 p. 169)
- The “Reset” operation can also be performed by using the button on the main unit. For details on resetting all of the settings to the factory defaults see “Resetting factory settings” (🔗 p. 194), and for details on resetting the network settings to the factory defaults see “Resetting network settings” (🔗 p. 195).

#### NOTE

- Do not disconnect the power or turn the device off during network settings initialization.



## Operating CD player with the remote control unit

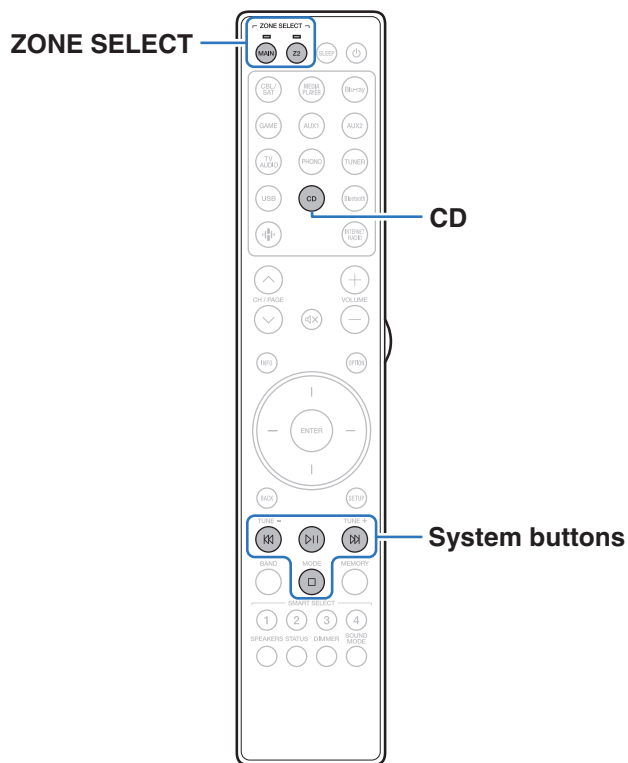

Press CD in the input source select buttons to operate your Marantz CD player with the system control buttons.

Operation buttons	Function
⏮ ⏭	Skip track
⏪ ⏩	Playback / Pause
⏹	Stop



- The zone selection button does not light up in CD control mode, even when the system control button is pressed.
- You can exit CD control mode by pressing the zone selection button, the power button, an input source button other than CD or the SMART SELECT button.



## Limiting the operating zone with the remote control

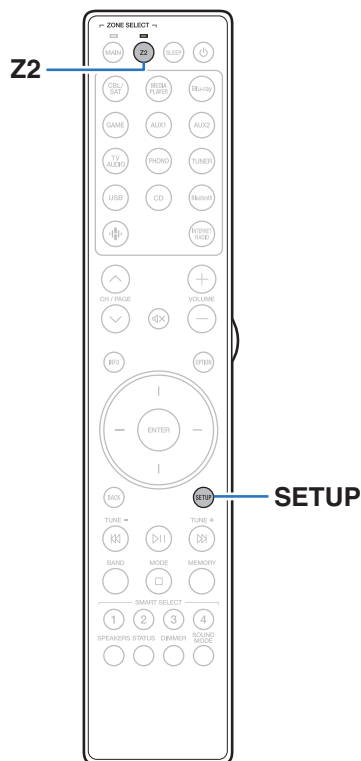

ZONE2 operations can be disabled using the remote control.

### 1 Press and hold Z2 and SETUP.

The MAIN and Z2 indicators blink.

### ■ Canceling the settings

#### 1 Press and hold Z2 and SETUP while configuring the setting.

The MAIN and Z2 indicators blink and the setting is canceled.



## Setting the back light of the remote control unit

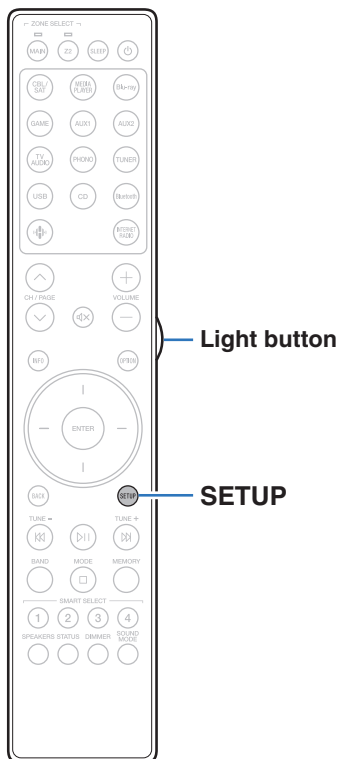

You can turn off the backlight of the remote control unit.

- Backlight is set on in the factory settings.

### Disabling the backlight

- 1 Press and hold both **SETUP** and **Light** button until the **MAIN** and **Z2** indicators on the remote are flashing green, then release.



- The backlight function can be turned on by performing step 1 again while the backlight function is off.



## ■ Contents

### Tips

I want the volume not to become too loud by mistake	175
I want to keep the volume at the same level when I turn the power on	175
I want to combine a desired video with the current music	175
I want to skip unused input sources	175
I want to enjoy the same music in all zones at the home party, etc.	175

### Troubleshooting

Power does not turn on / Power is turned off	177
Operations cannot be performed through the remote control unit	178
Display on this unit shows nothing	178
No sound comes out	179
Desired sound does not come out	180
Sound is interrupted or noise occurs	182
No video is shown on the TV	183
The menu screen is not displayed on the TV	184
The color of the menu screen and operations content displayed on the television is different from normal	184
AirPlay cannot be played back	185
USB memory devices cannot be played back	186
Bluetooth cannot be played back	187
The Internet radio cannot be played back	189
Music files on PC or NAS cannot be played back	190
Various online services cannot be played	191
The HDMI Control function does not work	191
Cannot connect to a wireless LAN network	192
Update error messages	193



# Tips

---

## I want the volume not to become too loud by mistake

- Set the volume upper limit for “Volume Limit” in the menu beforehand. This prevents children or others from increasing the volume too much by mistake. You can set this for each zone. (“Volume” (📖 p. 130), “Volume Limit” (📖 p. 161))

## I want to keep the volume at the same level when I turn the power on

- By default, the volume setting when power was previously set to standby on this unit is applied at next power on with no change. To use a fixed volume level, set the volume level at power on for “Power On Volume” in the menu. You can set this for each zone. (“Volume” (📖 p. 130), “Power On Volume” (📖 p. 161))

## I want to combine a desired video with the current music

- Set “Video Select” in the option menu to “On”. You can combine the current music with your desired video source from a Set-top Box or Blu-ray, etc. while listening to music from the Tuner, CD, Phono, HEOS Music, USB or Bluetooth. (📖 p. 100)

## I want to skip unused input sources

- Set unused input sources for “Hide Sources” in the menu. This allows you to skip unused input sources when turning the INPUT selector knob on this unit. (📖 p. 143)

## I want to enjoy the same music in all zones at the home party, etc.

- Set “All Zone Stereo” in the option menu to “Start”. You can simultaneously play back music in another room (ZONE2) that is played back in MAIN ZONE. (📖 p. 101)



# Troubleshooting

---

If a problem should arise, first check the following:

1. **Are the connections correct?**
2. **Is the set being operated as described in the owner's manual?**
3. **Are the other devices operating properly?**



- If steps 1 to 3 do not resolve the problem, try restarting the device.  
Follow the steps below to restart.

1. When this unit is turned on, press and hold  $\phi$  on the main unit until "SPECIAL MODE" appears on the display.
2. Turn the INPUT selector knob on the main unit to select "1Reboot", then press  $\phi$ .

You can also try unplugging and re-inserting this unit's power cord.

If this unit does not operate properly, check the corresponding symptoms in this section.

If the symptoms do not match any of those described here, consult your dealer as it could be due to a fault in this unit. In this case, disconnect the power immediately and contact the store where you purchased this unit.





## Power does not turn on / Power is turned off

### Power does not turn on.

- Check whether the power plug is correctly inserted into the power outlet. (👉 p. 51)

### Power automatically turns off.

- The sleep timer is set. Turn on the power again. (👉 p. 105)
- “Auto Standby” is set. “Auto Standby” is triggered when there is no operation for a set amount of time. To disable “Auto Standby”, set “Auto Standby” on the menu to “Off”. (👉 p. 159)

### Power turns off and the protection circuit indicator flashes in orange approx. every 2 seconds.

- The protection circuit has been activated due to a rise in temperature within this unit. Turn the power off, wait about an hour until this unit cools down sufficiently, and then turn the power on again. (👉 p. 209)
- Please re-install this unit in a place having good ventilation.

### Power turns off and the protection circuit indicator flashes in orange approx. every 0.5 seconds.

- Check the speaker connections. The protection circuit may have been activated because speaker cable core wires came in contact with each other or a core wire was disconnected from the connector and came in contact with the rear panel of this unit. After unplugging the power cord, take corrective action such as firmly re-twisting the core wire or taking care of the connector, and then reconnect the wire. (👉 p. 28)
- Turn down the volume and turn on the power again. (👉 p. 53)
- This unit’s amplifier circuit has failed. Unplug the power cord and contact our customer service center.

### Power does not turn off even when the power button is pressed, and the display shows “ZONE2 On”.

- The power supply of ZONE2 is turned to ON. To turn off the power supply of this unit (standby), press the POWER ⏻ button after pressing the Z2 button on the remote control unit to turn off the power supply of ZONE2.



## Operations cannot be performed through the remote control unit

### Operations cannot be performed through the remote control unit.

- Batteries are worn out. Replace with new batteries. (👉 p. 9)
- Operate the remote control unit within a distance of about 23 ft/7 m from this unit and at an angle of within 30°. (👉 p. 9)
- Remove any obstacle between this unit and the remote control unit.
- Insert the batteries in the proper direction, checking the ⊕ and ⊖ marks. (👉 p. 9)
- The set's remote control sensor is exposed to strong light (direct sunlight, inverter type fluorescent bulb light, etc.). Move the set to a place in which the remote control sensor will not be exposed to strong light.
- The operation target zone does not correspond to the zone setting specified on the remote control unit. Press the MAIN or Z2 button to select the operating zone of the remote control. (👉 p. 128)
- When using a 3D video device, the remote control unit of this unit may not function due to effects of infrared communications between units (such as TV and glasses for 3D viewing). In this case, adjust the direction of units with the 3D communications function and their distance to ensure they do not affect operations from the remote control unit of this unit.
- The remote control unit operating mode is used to operate CD player device. Press the corresponding zone selection button (MAIN or Z2) to operate HEOS Music or the Tuner. (👉 p. 171)

## Display on this unit shows nothing

### Display is off.

- Set "Brightness" on the menu to something other than "Off". (👉 p. 163)
- When the sound mode is set to "Pure Direct", the display is off. (👉 p. 102)



## No sound comes out

### No sound comes out of speakers.

- This unit supports analog audio signals and PCM 2-channel signals. To play sources such as Dolby Digital discs, set “PCM 2ch” as the audio format in the audio device settings.
- Check the connections for all devices. (🔍 p. 28)
- Insert connection cables all the way in.
- Check that input connectors and output connectors are not reversely connected.
- Check cables for damage.
- Check that speaker cables are properly connected. Check that cable core wires come in contact with the metal part on speaker terminals. (🔍 p. 28)
- Securely tighten the speaker terminals. Check speaker terminals for looseness. (🔍 p. 28)
- Check that a proper input source is selected. (🔍 p. 53)
- Adjust the volume. (🔍 p. 54)
- Cancel the mute mode. (🔍 p. 54)
- Check the digital audio input connector setting. (🔍 p. 140)
- Check the digital audio output setting on the connected device. On some devices, the digital audio output is set to off by default.
- When a headphone is plugged into the PHONES jack on the main unit, sound is not output from the speaker terminal and PRE OUT connector.
- Check the settings for the SPEAKERS switching knob.

### No sound comes out when using the DVI-D connection.

- When this unit is connected to a device equipped with a DVI-D connector, no sound is output. Make a separate audio connection.



## Desired sound does not come out

### The volume does not increase.

- The maximum volume is set too low. Set the maximum volume using “Limit” on the menu. (👉 p. 130)
- Appropriate volume correction processing is performed according to the input audio format and settings, so the volume may not reach the upper limit.

### The Bluetooth headphones do not have volume control and the volume is too low or too high.

- Control the volume by adjusting the “Level” of the “Bluetooth Transmitter” from the option menu. (👉 p. 65)

### The Bluetooth headphones have a volume control function but the volume is still too low or too high.

- Control the volume by adjusting the “Level” of the “Bluetooth Transmitter” from the option menu. (👉 p. 65)

### No sound comes out with the HDMI connection.

- Check the connection of the HDMI connectors. (👉 p. 35)
- When outputting HDMI audio from the speakers, set “HDMI Audio Out” on the menu to “Stereo Receiver”. To output from the TV, set “TV”. (👉 p. 131)
- When using the HDMI Control function, check that the audio output is set to the AV amplifier on the TV. (👉 p. 104)

### No sound comes out of a specific speaker.

- Check that speaker cables are properly connected.
- Check that a selection “Yes” is set for the “Speaker Layout” – “Subwoofer” setting in menu. (👉 p. 144)



**No sound is produced from subwoofer.**

- Check the subwoofer connections.
- Turn on the subwoofer's power.
- Set "Speaker Layout" – "Subwoofer" on the menu to "Yes". (👉 p. 144)

**"M-DAX" cannot be selected.**

- Check that an analog signal or PCM signal (Sample Rate = 44.1/48 kHz) is input. (👉 p. 129)
- Switch to a sound mode other than "Direct" or "Pure Direct". (👉 p. 102)

**No sound is output when using ZONE2.**

- The analog audio signal and the 2-channel PCM signal input from digital connectors (OPTICAL/COAXIAL) can be played back in ZONE2.
- When listening to audio from a Bluetooth device in ZONE2, remove any obstructions between the Bluetooth device and this unit and use it within a range of about 98.4 ft/30 m.

**Sound mode settings are not available when using Bluetooth headphones. Audio menu settings are also not available.**

- This unit cannot change sound mode or audio menu settings for audio output to Bluetooth headphones.



## Sound is interrupted or noise occurs

### During playback from the Internet radio or USB memory device, sound is occasionally interrupted.

- When the transfer speed of the USB memory device is slow, sound may occasionally be interrupted.
- The network communication speed is slow or the radio station is busy.

### When making a call on iPhone, noise occurs in audio output on this unit.

- When making a call, keep a distance of 0.7 ft/20 cm or longer between iPhone and this unit.

### Noise often occurs in FM/AM broadcasting.

- Change the antenna orientation or position. (🔧 p. 44)
- Separate the AM loop antenna from the unit.
- Use an outdoor antenna. (🔧 p. 44)
- Separate the antenna from other connection cables. (🔧 p. 44)

### The sounds appear to be distorted.

- Lower the volume. (🔧 p. 54)
- Set "Off" to the "ECO Mode". When "On" or "Auto" is in the "ECO Mode", the audio may be distorted when the playback volume is high. (🔧 p. 156)

### Sound cuts out when using Wi-Fi connection.

- The frequency band used by the wireless LAN is also used by microwave ovens, cordless telephones, wireless game controllers and other wireless LAN devices. Using such devices at the same time as this unit may cause sound to cut out due to electronic interference. Sound cut out can be improved using the following methods. (🔧 p. 46)
  - Install devices that cause interference away from this unit.
  - Turn off the power supply to devices that cause interference.
  - Change the settings of the router channel to which this unit is connected to. (See the instruction manual of the wireless router for details on how to change the channel.)
  - Switch to a wired LAN connection.
- Particularly when you play back large music files, depending on your wireless LAN environment, the playback sound may be interrupted. In this case, make the wired LAN connection. (🔧 p. 148)



## No video is shown on the TV

### No picture appears.

- Check the connections for all devices. (👉 p. 35)
- Insert connection cables all the way in.
- Check that input connectors and output connectors are not reversely connected.
- Check cables for damage.
- Match the input settings to the input connector of the TV connected to this unit. (👉 p. 140)
- Check that the proper input source is selected. (👉 p. 53)
- Check the video input connector setting. (👉 p. 140)
- Check that the resolution of the player corresponds to that of the TV. (👉 p. 167)
- Check whether the TV is compatible with copyright protection (HDCP). If connected to a device not compatible with HDCP, video will not be output correctly. (👉 p. 199)
- To enjoy content that is copyright protected by HDCP 2.2 or HDCP 2.3, use a playback device and TV compatible with HDCP 2.2 or HDCP 2.3.
- To play back a 4K video, use a “High Speed HDMI Cable” or a “High Speed HDMI Cable with Ethernet”. In order to achieve a higher fidelity for 4K videos, it is recommended to use a “Premium High Speed HDMI Cables” or a “Premium High Speed HDMI Cables with Ethernet” that has an HDMI Premium Certified Cable label on the product package.
- Use a certified “Ultra High Speed HDMI cable” to enjoy 8K or 4K 120Hz video. If you use a different HDMI cable, the video may not display or other problems may occur.

### No video is shown on the TV with the DVI-D connection.

- With the DVI-D connection, on some device combinations, devices may not function properly due to the copy guard copyright protection (HDCP). (👉 p. 199)

### While the menu is being displayed, no video is shown on the TV.

- The video being played will not appear in the background of the menu when the menu is operated.



## The menu screen is not displayed on the TV

### The menu screen or status information screen is not displayed on the TV.

- The status information will not appear on the TV when the following video signals are being played.
  - Some images of 3D video content
  - Computer resolution images (example: VGA)
  - Video with an aspect ratio other than 16:9 or 4:3
  - Some kind of HDR signals
  - Some kind of game contents
  - Compressed video
- When a 2D video is converted to a 3D video on the TV, the menu screen or status information screen is not displayed properly. (👉 p. 168)

## The color of the menu screen and operations content displayed on the television is different from normal

### The color of the menu screen and operations content displayed on the television is different.

- A different menu screen or operation colors from usual may be displayed when operating this unit while playing some HDR signals. This is due to the characteristics of those HDR signals and is not a malfunction.





## AirPlay cannot be played back

### The AirPlay icon is not displayed on iTunes / iPhone / iPod touch / iPad.

- This unit and PC / iPhone / iPod touch / iPad are not connected to the same network (LAN). Connect it to the same LAN as this unit. (👉 p. 46)
- The firmware on iTunes / iPhone / iPod touch / iPad is not compatible with AirPlay. Update the firmware to the latest version.

### Audio is not output.

- The volume on iTunes / iPhone / iPod touch / iPad is set to the minimum level. The volume on iTunes / iPhone / iPod touch / iPad is linked with the volume on this unit. Set a proper volume level.
- The AirPlay playback is not performed, or this unit is not selected. Click the AirPlay icon on the iTunes / iPhone / iPod touch / iPad screen and select this unit. (👉 p. 91)

### Audio is interrupted during the AirPlay playback on iPhone / iPod touch / iPad.

- Quit the application running in the background of the iPhone/iPod touch/iPad, and then play using AirPlay.
- Some external factors may be affecting the wireless connection. Modify the network environment by taking measures such as shortening the distance from the wireless LAN access point.

### iTunes cannot be played back through the remote control unit.

- Enable the “Allow iTunes audio control from remote speakers” setting on iTunes. Then, you can perform playback, pause, and skip operations through the remote control unit.



## USB memory devices cannot be played back

### USB memory device is not recognized.

- Disconnect and reconnect the USB memory device. (👉 p. 43)
- Mass storage class compatible USB memory devices are supported.
- This unit does not support a connection through a USB hub. Connect the USB memory device directly to the USB port.
- The USB memory device must be formatted to “FAT32” or “NTFS”.
- Not all USB memory devices are guaranteed to work. Some USB memory devices are not recognized. When using a type of portable hard disc drive compatible with the USB connection that requires power from an AC adapter, use the AC adapter that came with the drive.

### Files on the USB memory device are not displayed.

- Files of a type not supported by this unit are not displayed. (👉 p. 55)
- This unit is able to display files in a maximum of eight folder layers. A maximum of 5000 files (folders) can also be displayed for each layer. Modify the folder structure of the USB memory device.
- When multiple partitions exist on the USB memory device, only files on the first partition are displayed.

### iOS and Android devices are not recognized.

- The USB port of this unit does not support playback from iOS and Android devices.

### Files on a USB memory device cannot be played.

- Files are created in a format that is not supported by this unit. Check the formats supported by this unit. (👉 p. 202)
- You are attempting to play a file that is copyright protected. Files that are copyright protected cannot be played on this unit.
- Playback may not be possible if the album art file size exceeds 2 MB.



## Bluetooth cannot be played back

### Bluetooth devices cannot be connected to this unit.

- The Bluetooth function in the Bluetooth device has not been enabled. See the Owner's Manual of the Bluetooth device to enable the Bluetooth function.
- Bring the Bluetooth device near to this unit.
- The Bluetooth device cannot connect with this unit if it is not compatible with the A2DP profile.
- Turn the power of the Bluetooth device off and on again, and then try again.

### Smartphones and other Bluetooth devices cannot be connected.

- Smartphones and other Bluetooth devices cannot be connected when "Transmitter" is set to "On". Press Bluetooth on the remote control to switch the input source to Bluetooth, then connect the device. (👉 p. 160)

### Cannot connect Bluetooth headphones.

- Bring the Bluetooth headphones near to this unit.
- Turn the power of the Bluetooth headphones off and on again, and then try again.
- Go to "General" - "Bluetooth Transmitter", and set "Transmitter" to "On" within the menu. (👉 p. 160)
- Make sure this unit is not already connected to another pair of Bluetooth headphones. Check the currently connected Bluetooth headphones by pressing INFO on the remote control or STATUS button on the unit. Disconnect the connected Bluetooth headphones before connecting the ones you want to use.
- Bluetooth headphones cannot be connected if Bluetooth is being used as an input source in any zone.
- Bluetooth headphones cannot be connected if this unit is grouped in the HEOS App. Remove this unit from the group to enable Bluetooth headphones connection.
- The Bluetooth headphones cannot connect with this unit if it is not compatible with the A2DP profile.
- Connection and operation are not guaranteed for all Bluetooth-enabled devices.
- This unit can only connect to one Bluetooth headphone at a time. However, up to 8 Bluetooth headphones can be registered. You can switch between registered devices from "Device List" in the "Bluetooth Transmitter" menu. (👉 p. 160)



**The sound is cut off.**

- Bring the Bluetooth device near to this unit.
- Remove obstructions between the Bluetooth device and this unit.
- To prevent electromagnetic interference, locate this unit away from microwave ovens, wireless LAN devices and other Bluetooth devices.
- Reconnect the Bluetooth device.

**The sound is cut off or noise occurs when using Bluetooth headphones.**

- Move the Bluetooth headphones closer to this unit.
- Remove obstructions between the Bluetooth headphones and this unit.
- Reconnect the Bluetooth headphones.
- To prevent electromagnetic interference, locate this unit away from microwave ovens, wireless LAN devices and other Bluetooth devices.
- We recommend using wired LAN to connect this unit and other devices.
- Bluetooth transmits on the 2.4 GHz band which may interfere with Wi-Fi transmitted on this band. Connect this unit and other devices to Wi-Fi network on a 5 GHz band if available on your Wi-Fi router.

**Audio is delayed on my Bluetooth headphones.**

- This unit cannot adjust audio delay on Bluetooth headphones.



## The Internet radio cannot be played back

### A list of broadcasting stations is not displayed.

- The LAN cable is not properly connected, or the network is disconnected. Check the connection status. (👉 p. 46)
- Perform the network diagnostic mode.

### Internet Radio cannot be played.

- The selected radio station is broadcasting in a format that is not supported by this unit. Formats that can be played back in this unit are MP3, WMA and AAC. (👉 p. 205)
- The firewall function is enabled on the router. Check the firewall setting.
- The IP address is not properly set. (👉 p. 149)
- Check the power of the router is on.
- To obtain the IP address automatically, enable the DHCP server function on the router. Also, set the DHCP setting to “On” on this unit. (👉 p. 149)
- To obtain the IP address manually, set the IP address on this unit. (👉 p. 149)
- Some radio stations broadcast silently during some time period. In this case, no audio is output. Wait for a while and select the same radio station, or select another radio station. (👉 p. 76)
- The selected radio station is not in service. Select a radio station in service.

### Cannot connect to favorite radio stations.

- Radio station is not currently in service. Register radio stations in service.



## Music files on PC or NAS cannot be played back

### Files stored on a computer cannot be played.

- Files are stored in a non-compatible format. Record in a compatible format. (🔍 p. 204)
- Files that are copyright protected cannot be played on this unit.
- The USB port of this unit cannot be used for connection to a computer.
- Media sharing settings on the server or NAS do not allow this unit. Change the settings to allow this unit. For details, see the owner's manual of the server or NAS.

### Server is not found, or it is not possible to connect to the server.

- The computer's or router's firewall is activated. Check the computer's or router's firewall settings.
- Computer's power is not turned on. Turn on the power.
- Server is not running. Launch the server.
- IP address of this unit is wrong. Check the IP address of this unit. (🔍 p. 147)

### Music files on PC cannot be played back.

- Even if PC is connected to the USB port on this unit, music files on it cannot be played back. Connect PC to this unit through the network. (🔍 p. 46)

### Files on PC or NAS are not displayed.

- Files of a type not supported by this unit are not displayed. (🔍 p. 204)

### Music stored on a NAS cannot be played.

- If you use a NAS in conformity with the DLNA standard, enable the DLNA server function in the NAS setting.
- If you use a NAS that does not conform with the DLNA standard, play the music via a PC. Set Windows Media Player's media sharing function and add NAS to the selected play folder.
- If connection is restricted, set audio equipment as the connection target.



## Various online services cannot be played

### Various online services cannot be played.

- The online service may have been discontinued.

## The HDMI Control function does not work

### The HDMI Control function does not work.

- Check that "HDMI Control" in the menu is set to "On". (👉 p. 133)
- You cannot operate devices that are not compatible with the HDMI Control function. In addition, depending on the connected device or the settings, the HDMI Control function may not work. In this case, operate the external device directly. (👉 p. 104)
- Check that the HDMI Control function setting is enabled on all devices connected to this unit. (👉 p. 104)
- When you make connection related changes such as connecting an additional HDMI device, the link operation settings may be initialized. Turn off this unit and devices connected via HDMI, and turn them on again. (👉 p. 104)



## Cannot connect to a wireless LAN network

### Cannot connect to the network.

- The network name (SSID), password and encryption setting have not been set up correctly. Configure the network settings according to the setting details of this unit. (📖 p. 149)
- Shorten the distance from the wireless LAN access point and remove any obstructions to improve access first before re-connecting again. Place the unit away from microwave ovens and other network access points.
- Configure the access point channel settings away from channels that are being used by other networks.
- This unit is not compatible with WEP (TSN).

### Cannot connect to a WPS Router.

- Check that the WPS mode of the router is operating.
- Press the WPS button on the router and then press the “Connect” button displayed on the TV within 2 minutes.
- A router/settings that are compatible with WPS 2.0 standards are required. Set the encryption type to “None”, “WPA-PSK (AES)” or WPA2-PSK (AES). (📖 p. 149)
- If the router encryption method is WEP/WPA-TKIP/WPA2-TKIP/WPA3-SAE (AES), you cannot connect by using the WPS button on the router. In this case, use the “Scan Networks” or “Manual” method to connect.

### Cannot connect to the network using iPhone/iPod touch/iPad.

- Update the iPhone/iPod touch/iPad firmware to the latest version.
- When configuring the settings via a wireless connection, iOS 10.0.2 or later needs to be supported.





## Update error messages

If an update is interrupted or fails, an error message appears.

Display	Description
<b>Connection failed. Please check your network, then try again.</b>	The network connection is unstable. Connection to the server failed. Check your network environment and try the update again.
<b>Update failed. Please check your network, then try again.</b>	The download of the firmware failed. Check your network environment and try the update again.
<b>Please check your network, unplug and reconnect the power cord, and try again.</b>	The update failed. Press and hold the  on the main unit for more than 5 seconds, or remove and re-insert the power cord. The update restarts automatically.
<b>Please contact customer service in your area.</b>	This unit may be broken. Contact our Customer Service Center in your area.



## Resetting factory settings



If the indicators are incorrect or the unit cannot be operated, restarting the unit may improve the problem. We recommend restarting the unit before returning the settings to the default settings. (👉 p. 176)

If the operations are not improved by restarting the unit, follow the steps below.

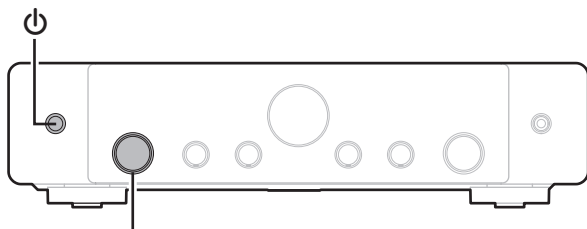
Various settings are reset to the factory default values. Make settings again.



**INPUT selector knob**

- 1** When this unit is turned on, press and hold  on the main unit until “SPECIAL MODE” appears on the display.
- 2** Turn the INPUT selector knob to select “2All Reset”, then press .



- Before returning the settings to the default settings, use the “Save & Load” function from the menu to save and restore the details of various settings configured on the unit. (👉 p. 169)
- You can also reset all settings to the factory defaults using “Reset” - “All Settings” in the menu. (👉 p. 170)



## Resetting network settings

If network contents cannot be played or the unit cannot connect to the network, restarting the unit may improve the problem. We recommend restarting the unit before returning the settings to the default settings. (👉 p. 176)

If the operations are not improved by restarting the unit, follow the steps below.

Network settings are reset to the factory default values. Make settings again.

However, the menu “Audio”, “Video” and “Speakers” settings are not reset.

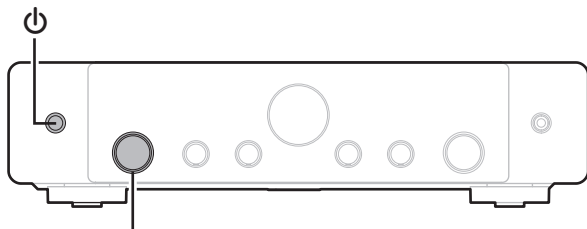

INPUT selector knob

- 1** When this unit is turned on, press and hold **⏻** on the main unit until “SPECIAL MODE” appears on the display.
- 2** Turn the INPUT selector knob to select “3Network Reset”, then press **⏻**.  
“Network Reset...” appears on the display.
- 3** “Complete” is shown in the display when reset is complete.



- Before returning the settings to the default settings, use the “Save & Load” function from the menu to save and restore the details of various settings configured on the unit. (👉 p. 169)
- You can also reset the network settings to the factory defaults using “Reset” - “Network Settings” in the menu. (👉 p. 170)

### NOTE

- Do not turn the power off until reset is complete.



# Factory Restore

When the unit or the network functions do not work properly, operation may be improved by performing the Factory Restore.

Do this when the unit still does not work properly even after trying the steps for “Resetting factory settings” or “Resetting network settings”. (☞ p. 194, 195)

After performing the Factory Restore, various settings are reset to the default settings. Configure the network settings and update the firmware again.

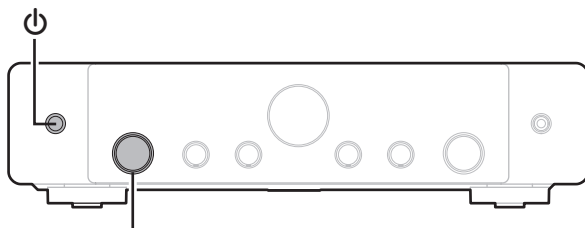

**INPUT selector knob**

- 1** When this unit is turned on, press and hold **⏻** on the main unit until “SPECIAL MODE” appears on the display.
- 2** Turn the **INPUT selector knob** to select “6Factory Restore”, then press **⏻**.  
A countdown appears on the display.
- 3** When the **Factory Restore** is complete, “Complete” appears on the display.



- This operation takes time because it requires reconnecting to the network, restoring and updating the firmware.
- If this operation does not improve the problem, contact our customer service center.

#### NOTE

- Do not turn off the power until the **Factory Restore** is complete.

#### WARNING

**By initiating Factory Restore mode, you will be installing limited recovery firmware on this unit. Functionality will remain limited until a firmware update is performed over the Internet. Do not perform a Factory Restore if you do not have this unit connected to your home network.**



## About HDMI

HDMI is an abbreviation of High-Definition Multimedia Interface, which is an AV digital interface that can be connected to a TV or amplifier.

With the HDMI connection, high definition video and high quality audio formats adopted by Blu-ray Disc players can be transmitted, which is not possible with the analog video transmission.

Furthermore, in the HDMI connection, audio and video signals can be transmitted through a single HDMI cable, while in conventional connections it is necessary to provide audio and video cables separately for connection between devices. This allows you to simplify the wiring configuration that tends to be quite complex in a home theater system.

This unit supports the following HDMI functions.

- **Deep Color**

An imaging technology supported by HDMI. Unlike RGB or YCbCr, which uses 8 bits (256 shades) per color, it can use 10 bits (1024 shades), 12 bits (4096 shades), or 16 bits (65536 shades) to produce colors in higher definition.

Both devices linked via HDMI must support Deep Color.

- **x.v.Color**

This function lets HDTVs display colors more accurately. It enables display with natural, vivid colors.

“x.v.Color” is trademark of Sony Corporation.

- **3D**

This unit supports input and output of 3D (3 dimensional) video signals of HDMI. To play back 3D video, you need a TV and player that provide support for the HDMI 3D function and a pair of 3D glasses.

- **4K / 8K**

This unit supports input and output of 4K (3840 x 2160 pixels) and 8K (7680 x 4320 pixels) video signals of HDMI.

- **Content Type**

It automatically makes settings suitable for the video output type (content information).

- **Adobe RGB color, Adobe YCC601 color**

The color space defined by Adobe Systems Inc. Because it is a wider color space than RGB, it can produce more vivid and natural images.

- **sYCC601 color**

Each of these color spaces defines a palette of available colors that is larger than the traditional RGB color model.



- **Auto Lip Sync**

This function can automatically correct delay between the audio and video.

Use a TV that is compatible with the Auto Lip Sync function.

- **HDMI Pass Through**

Even when the power to this unit is set to standby, signals input from the HDMI input connector are output to a TV or other device that is connected to the HDMI output connector.

- **HDMI Control**

If you connect the unit and an HDMI Control function compatible TV or player with an HDMI cable and then enable the HDMI Control function setting on each device, the devices will be able to control each other.

- Power off link

This unit power off can be linked to the TV power off step.

- Audio output destination switching

From the TV, you can switch whether to output audio from the TV or the AV amplifier.

- Volume adjustment

You can adjust this unit's volume in the TV volume adjustment operation.

- Input source switching

You can switch this unit input sources through linkage to TV input switching.

When playing the player, this unit input source switches to the source for that player.

- **ARC (Audio Return Channel)**

This function transmits audio signals from the TV to this unit through the HDMI cable and plays back the audio from the TV on this unit based on the HDMI Control function.

If a TV without the ARC function is connected via HDMI connections, video signals of the playback device connected to this unit are transmitted to the TV, but this unit can not play back the audio from the TV. If you want to enjoy surround audio for TV program, a separate audio cable connection is required.

In contrast, if a TV with the ARC function is connected via HDMI connections, no audio cable connection is required. Audio signals from the TV can be input to this unit through the HDMI cable between this unit and the TV. This function allows you to enjoy surround playback on this unit for the TV.

- **ALLM (Auto Low Latency Mode)**

This unit automatically switches to low latency mode depending on playback contents when using a combination of television and game console compatible with the ALLM function.

- **VRR (Variable Refresh Rate):**

VRR reduces or eliminates lag, stutter and frame tearing for more fluid and better detailed gameplay.



- **QFT (Quick Frame Transport):**

QFT reduces latency for smoother no-lag gaming, and real-time interactive virtual reality.

- **FRL (Fixed Rate Link):**

FRL (Fixed Rate Link) is transmission technology that is required to provide higher resolutions such as ultra high speed bandwidths of 4K 60Hz or higher.

**NOTE**

- Some functions may not operate depending on the connected TV or player. Check the owner's manual of each device for details beforehand.

## ■ Supported audio formats

2-channel Linear PCM	2-channel, 32 kHz – 192 kHz, 16/20/24 bit
----------------------	---

## ■ Supported video signals

- 480i
- 480p
- 576i
- 576p
- 720p 60/50Hz
- 1080i 60/50Hz
- 1080p 120/100/60/50/24Hz
- 4K 120/100/60/50/30/25/24Hz
- 8K 60/50/30/25/24Hz

### Copyright protection system

In order to play back digital video and audio such as BD video or DVD video via HDMI connection, both this unit and the TV or player must to support the copyright protection system known as HDCP (High-bandwidth Digital Content Protection System). HDCP is copyright protection technology comprised of data encryption and authentication of the connected AV devices. This unit supports HDCP.

- If a device that does not support HDCP is connected, video and audio are not output correctly. Read the owner's manual of your television or player for more information.



## Relationship between video signals and TV output

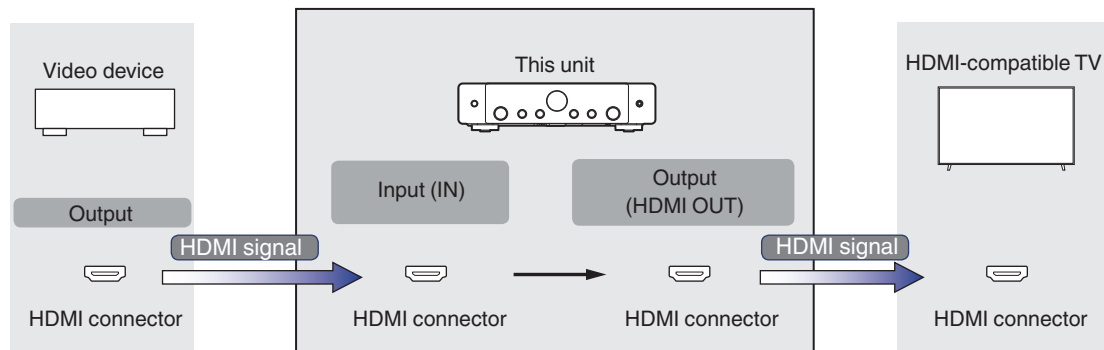

### NOTE

- Only HDMI connections are available for the video input/output of this unit.





When “HDMI Upscaler” in the menu is set to “Auto”, this unit upscales the input HDMI video signal and then outputs it to the TV. (🔍 p. 135)

Input signal \ Output signal		HDMI												
		480i/576i	480p/576p	720p	1080i	1080p 30/25/24Hz	1080p 60/50Hz	1080p 120/100Hz	4K 30/25/24Hz	4K 60/50Hz	4K 120/100Hz	8K 30/25/24Hz	8K 60/50Hz	
HDMI	480i/576i	✓												
	480p/576p		✓											
	720p			✓										
	1080i				✓									
	1080p 30/25/24Hz					✓		✓			✓			
	1080p 60/50Hz						✓		✓				✓	
	1080p 120/100Hz							✓						
	4K 30/25/24Hz								✓			✓		
	4K 60/50Hz									✓				✓
	4K 120/100Hz										✓*			
	8K 30/25/24Hz											✓*		
8K 60/50Hz												✓*		

\* Supported by the HDMI 4, 5 and 6 connectors.



## Playing back a USB memory devices

- This unit is compatible with MP3 ID3-Tag (Ver. 2) standard.
- This unit can show the artwork that was embedded by using MP3 ID3-Tag Ver. 2.3 or 2.4.
- This unit is compatible with WMA META tags.
- If the image size (pixels) of an album artwork exceeds 500 × 500 (WMA/MP3/Apple Lossless/DSD) or 349 × 349 (MPEG-4 AAC), then music may not be played back properly.

### Compatible formats

	Sampling frequency	Channel	Bit rate	Extension
WMA*1	32/44.1/48 kHz	2-channel	48 – 192 kbps	.wma
MP3	32/44.1/48 kHz	2-channel	32 – 320 kbps	.mp3
WAV	32/44.1/48/88.2/ 96/176.4/192 kHz	2-channel	–	.wav
MPEG-4 AAC*1	32/44.1/48 kHz	2-channel	48 - 320 kbps	.aac/.m4a
FLAC	44.1/48/88.2/ 96/176.4/192 kHz	2-channel	–	.flac
Apple Lossless*2	44.1/48/88.2/ 96/176.4/192 kHz	2-channel	–	.m4a
DSD	2.8/5.6 MHz	2-channel	–	.dsf/.dff

\*1 Only files that are not protected by copyright can be played on this unit.

Content downloaded from pay sites on the Internet are copyright protected. Also, files encoded in WMA format when ripped from a CD, etc. on a computer may be copyright protected, depending on the computer's settings.

\*2 The Apple Lossless Audio Codec (ALAC) decoder is distributed under the Apache License, Version 2.0 (<http://www.apache.org/licenses/LICENSE-2.0>).



## ■ Maximum number of playable files and folder

The limits on the number of folders and files that can be displayed by this unit are as follows.

Item	Media	USB memory device
Number of folder directory levels *1		8 levels
Number of folders		500
Number of files*2		5000

\*1 The limited number includes the root folder.

\*2 The allowable number of files may differ according to the USB memory device capacity and the file size.

## Playing back a Bluetooth device

This unit supports the following Bluetooth profile.

- A2DP (Advanced Audio Distribution Profile):  
When a Bluetooth device that supports this standard is connected, monaural and stereo sound data can be streamed at a high quality.
- AVRCP (Audio/Video Remote Control Profile):  
When a Bluetooth device that supports this standard is connected, the Bluetooth device can be operated from this unit.

## ■ About Bluetooth communications

Radio waves broadcast from this unit may interfere with the operation of medical devices. Make sure you turn off the power of this unit and Bluetooth device in the following locations as radio wave interference may cause malfunctions.

- Hospitals, trains, aircraft, petrol kiosks and places where flammable gases are generated
- Near automatic doors and fire alarms



## Playing back a file saved on a PC or NAS

- This unit is compatible with MP3 ID3-Tag (Ver. 2) standard.
- This unit can show the artwork that was embedded by using MP3 ID3-Tag Ver. 2.3 or 2.4.
- This unit is compatible with WMA META tags.
- If the image size (pixels) of an album artwork exceeds 500 × 500 (WMA/MP3/WAV/FLAC/Apple Lossless/DSD) or 349 × 349 (MPEG-4 AAC), then music may not be played back properly.
- A server or server software compatible with distribution in the corresponding formats is required to play music files via a network.  
For playing mentioned audio formats via a network a server software, for example Twonky Media Server or jRiver Media Server, needs to be installed on your computer or NAS for full support. There are other server software available too. Please check supported formats.

### ■ Specifications of supported files

	Sampling frequency	Channel	Bit rate	Extension
WMA*1	32/44.1/48 kHz	2-channel	48 – 192 kbps	.wma
MP3	32/44.1/48 kHz	2-channel	32 – 320 kbps	.mp3
WAV	32/44.1/48/88.2/ 96/176.4/192 kHz	2-channel	–	.wav
MPEG-4 AAC*1	32/44.1/48 kHz	2-channel	48 - 320 kbps	.aac/.m4a
FLAC	44.1/48/88.2/ 96/176.4/192 kHz	2-channel	–	.flac
Apple Lossless*2	44.1/48/88.2/ 96/176.4/192 kHz	2-channel	–	.m4a
DSD	2.8/5.6 MHz	2-channel	–	.dsf/.dff

\*1 Only files that are not protected by copyright can be played on this unit.

Content downloaded from pay sites on the Internet are copyright protected. Also, files encoded in WMA format when ripped from a CD, etc. on a computer may be copyright protected, depending on the computer's settings.

\*2 The Apple Lossless Audio Codec (ALAC) decoder is distributed under the Apache License, Version 2.0 (<http://www.apache.org/licenses/LICENSE-2.0>).



## Playing back Internet Radio

### ■ Playable broadcast station specifications

	Sampling frequency	Bit rate	Extension
WMA	32/44.1/48 kHz	48 - 192 kbps	.wma
MP3	32/44.1/48 kHz	32 - 320 kbps	.mp3
MPEG-4 AAC	32/44.1/48 kHz	48 - 320 kbps	.aac/ .m4a

## Personal memory plus function

The most recently used settings (input mode, HDMI output mode, sound mode, tone control, Balance, M-DAX and Audio Delay, etc.) are saved for each input source.

## Last function memory

This function stores the settings which were made before going into the standby mode.



## Explanation of terms

### ■ Audio

#### Apple Lossless Audio Codec

This is a codec for lossless audio compression method developed by Apple Inc. This codec can be played back on iTunes, iPod or iPhone. Data compressed to approximately 60 – 70 % can be decompressed to exactly the same original data.

#### FLAC (Free Lossless Audio Codec)

FLAC stands for Free lossless Audio Codec, and is a lossless free audio file format. Lossless means that the audio is compressed without any loss in quality.

The FLAC license is as shown below.

Copyright (C) 2000, 2001, 2002, 2003, 2004, 2005, 2006, 2007, 2008, 2009 Josh Coalson

Redistribution and use in source and binary forms, with or without modification, are permitted provided that the following conditions are met:

- Redistributions of source code must retain the above copyright notice, this list of conditions and the following disclaimer.
- Redistributions in binary form must reproduce the above copyright notice, this list of conditions and the following disclaimer in the documentation and/or other materials provided with the distribution.
- Neither the name of the Xiph.org Foundation nor the names of its contributors may be used to endorse or promote products derived from this software without specific prior written permission.

THIS SOFTWARE IS PROVIDED BY THE COPYRIGHT HOLDERS AND CONTRIBUTORS "AS IS" AND ANY EXPRESS OR IMPLIED WARRANTIES, INCLUDING, BUT NOT LIMITED TO, THE IMPLIED WARRANTIES OF MERCHANTABILITY AND FITNESS FOR A PARTICULAR PURPOSE ARE DISCLAIMED. IN NO EVENT SHALL THE FOUNDATION OR CONTRIBUTORS BE LIABLE FOR ANY DIRECT, INDIRECT, INCIDENTAL, SPECIAL, EXEMPLARY, OR CONSEQUENTIAL DAMAGES (INCLUDING, BUT NOT LIMITED TO, PROCUREMENT OF SUBSTITUTE GOODS OR SERVICES; LOSS OF USE, DATA, OR PROFITS; OR BUSINESS INTERRUPTION) HOWEVER CAUSED AND ON ANY THEORY OF LIABILITY, WHETHER IN CONTRACT, STRICT LIABILITY, OR TORT (INCLUDING NEGLIGENCE OR OTHERWISE) ARISING IN ANY WAY OUT OF THE USE OF THIS SOFTWARE, EVEN IF ADVISED OF THE POSSIBILITY OF SUCH DAMAGE.

#### MP3 (MPEG Audio Layer-3)

This is an internationally standardized audio data compression scheme, using the "MPEG-1" video compression standard. It compresses the data volume to about one eleventh its original size while maintaining sound quality equivalent to a music CD.



## MPEG (Moving Picture Experts Group), MPEG-2, MPEG-4

These are the names for digital compression format standards used for the encoding of video and audio. Video standards include “MPEG-1 Video”, “MPEG-2 Video”, “MPEG-4 Visual”, “MPEG-4 AVC”. Audio standards include “MPEG-1 Audio”, “MPEG-2 Audio”, “MPEG-4 AAC”.

## WMA (Windows Media Audio)

This is audio compression technology developed by Microsoft Corporation.

WMA data can be encoded using Windows Media® Player.

To encode WMA files, only use applications authorized by Microsoft Corporation. If you use an unauthorized application, the file may not work properly.

## Sampling frequency

Sampling involves taking a reading of a sound wave (analog signal) at regular intervals and expressing the height of the wave at each reading in digitized format (producing a digital signal).

The number of readings taken in one second is called the “sampling frequency”. The larger the value, the closer the reproduced sound is to the original.

## Speaker impedance

This is an AC resistance value, indicated in  $\Omega$  (ohms).

Greater power can be obtained when this value is smaller.

## ■ Video

### Progressive (sequential scanning)

This is a scanning system of the video signal that displays 1 frame of video as one image. Compared to the interlace system, this system provides images with less flickering and jagged edges.

## ■ Network

### AirPlay

AirPlay sends (plays) contents recorded in iTunes or on an iPhone/iPod touch/iPad to a compatible device via the network.

### WEP Key (network key)

This is key information used for encrypting data when conducting data transfer. On this unit, the same WEP key is used for data encryption and decryption, so the same WEP key must be set on both devices in order for communications to be established between them.

### Wi-Fi®

Wi-Fi Certification assures tested and proven interoperability by the Wi-Fi Alliance, a group certifying interoperability among wireless LAN devices.



### WPA (Wi-Fi Protected Access)

This is a security standard established by the Wi-Fi Alliance. In addition to the conventional SSID (network name) and WEP key (network key), it also uses a user identification function and encrypting protocol for stronger security.

### WPA2 (Wi-Fi Protected Access 2)

This is a new version of the WPA established by the Wi-Fi Alliance, compatible with more secure AES encryption.

### WPA-PSK/WPA2-PSK (Pre-shared Key)

This is a simple authentication system for mutual authentication when a preset character string matches on the wireless LAN access point and client.

### WPA2/WPA3-Personal

WPA2/WPA3-Personal Mode was defined by Wi-Fi Alliance® to minimize user disruption and provide a gradual migration path to WPA3-Personal while maintaining interoperability with WPA2-Personal only devices.

### WPA3-Personal

WPA3-Personal replaces the WPA2-Personal Pre-Shared Key (PSK) authentication with Simultaneous authentication of equals (SAE). Unlike PSK, SAE is resistant to offline dictionary attacks.

### Network Names (SSID: Service Set Identifier)

When forming wireless LAN networks, groups are formed to prevent interference, data theft, etc. These groups are based on “SSID (network names)”. For enhanced security, a WEP key is set so that communication is unavailable unless both the “SSID” and the WEP key match. This is suitable for constructing a simplified network.





## ■ Others

### HDCP

When transmitting digital signals between devices, this copyright protection technology encrypts the signals to prevent content from being copied without authorization.

### MAIN ZONE

The room where this unit is placed is called the MAIN ZONE.

### Pairing

Pairing (registration) is an operation that is required in order to connect a Bluetooth device to this unit using Bluetooth. When paired, the devices authenticate each other and can connect without mistaken connections occurring.

When using Bluetooth connection for the first time, you need to pair this unit and the Bluetooth device to be connected.

### Protection circuit

This is a function to prevent damage to devices within the power supply when an abnormality such as an overload, excess voltage occurs or over temperature for any reason.



## Trademark information



Apple, AirPlay, iPad, iPad Air, iPad Pro and iPhone are trademarks of Apple Inc., registered in the U.S. and other countries.

The trademark "iPhone" is used in Japan with a license from Aiphone K.K.

Use of the Works with Apple badge means that an accessory has been designed to work specifically with the technology identified in the badge and has been certified by the developer to meet Apple performance standards.



The Bluetooth® word mark and logos are registered trademarks owned by the Bluetooth SIG, Inc. and any use of such marks by D&M Holdings Inc. is under license. Other trademarks and trade names are those of their respective owners.



The terms HDMI, HDMI High-Definition Multimedia Interface, HDMI Trade dress and the HDMI Logos are trademarks or registered trademarks of HDMI Licensing Administrator, Inc.

HDR10+™ logo is a trademark of HDR10+ Technologies, LLC.



The Wi-Fi CERTIFIED logo is a registered trademark of the Wi-Fi Alliance.

Wi-Fi Certification provides assurance that the device has passed the interoperability test conducted by the Wi-Fi Alliance, a group that certifies interoperability among wireless LAN devices.





App Store® is registered in the U.S. and other countries.



Google Play and the Google Play logo are trademarks of Google LLC.



# Specifications

## Audio section

- **Power amplifier**

**Rated output:** 75 W + 75 W (8  $\Omega$ /ohms, 20 Hz – 20 kHz with 0.08 % T.H.D.)  
100 W + 100 W (6  $\Omega$ /ohms, 1 kHz with 0.7 % T.H.D.)

**Output connectors:** 4 – 16  $\Omega$ /ohms

- **Analog**

**Input sensitivity:** 130 mV

**Frequency response:** 10 Hz – 100 kHz — +1, –3 dB (Direct mode)

**S/N:** 98 dB (IHF–A weighted, Direct mode)

- **Phono equalizer**

**Input sensitivity:** 2.5 mV

**RIAA deviation:**  $\pm$ 1 dB (20 Hz to 20 kHz)

**S/N:** 74 dB (IHF-A)

**Distortion factor:** 0.03 % (1 kHz, 3 V)



## Tuner section

	[FM]	[AM]
	(Note: $\mu\text{V}$ at 75 $\Omega$ /ohms, 0 dBf = $1 \times 10^{-15}$ W)	
<b>Reception frequency range:</b>	87.5 MHz – 107.9 MHz	520 kHz – 1710 kHz
<b>Effective sensitivity:</b>	1.2 $\mu\text{V}$ (12.8 dBf)	18 $\mu\text{V}$
<b>50 dB sensitivity:</b>	MONO – 2.8 $\mu\text{V}$ (20.2 dBf)	
<b>S/N ratio:</b>	MONO – 70 dB (IHF–A weighted, Direct mode) STEREO – 67 dB (IHF–A weighted, Direct mode)	
<b>Distortion:</b>	MONO – 0.7 % (1 kHz) STEREO – 1.0 % (1 kHz)	

## Wireless LAN section

<b>Network type (wireless LAN standard):</b>	Conforming to IEEE 802.11a/b/g/n/ac (Wi-Fi® compliant) *1
<b>Security:</b>	WEP 64 bit, WEP 128 bit WPA/WPA2-PSK (AES) WPA/WPA2-PSK (TKIP) WPA3-SAE (AES)
<b>Used frequency range:</b>	2.4 GHz, 5 GHz

\*1 The Wi-Fi® CERTIFIED Logo and the Wi-Fi CERTIFIED On-Product Logo are registered trademarks of the Wi-Fi Alliance.



## Bluetooth section

<b>Communications system:</b>	Bluetooth Specification Version 5.4
<b>Transmission power:</b>	Bluetooth Specification Power Class 1
<b>Maximum communication range:</b>	Approx. 98.4 ft/30 m in line of sight *2
<b>Used frequency range:</b>	2.4 GHz
<b>Modulation scheme:</b>	FHSS (Frequency-Hopping Spread Spectrum)
<b>Supported profiles:</b>	Receiver function A2DP (Advanced Audio Distribution Profile) 1.4 AVRCP (Audio Video Remote Control Profile) 1.5 Transmitter function A2DP (Advanced Audio Distribution Profile) 1.4
<b>Corresponding codec:</b>	SBC
<b>Transmission range (A2DP):</b>	20 Hz – 20,000 Hz

\*2 The actual communication range varies depending on the influence of such factors as obstructions between devices, electromagnetic waves from microwave ovens, static electricity, cordless phones, reception sensitivity, antenna performance, operating system, application software etc.



## General

<b>Operating temperature:</b>	41 °F - 95 °F (5 °C - 35 °C)
<b>Power supply:</b>	AC 120 V, 60 Hz
<b>Power consumption:</b>	210 W
<b>Power consumption in standby mode:</b>	0.2 W*
<b>Power consumption in CEC standby mode:</b>	0.5 W

\* When “Network Control” in the menu is set to “Off In Standby” and “HDMI Pass Through” is set to “Off”.

For purposes of improvement, specifications and design are subject to change without notice.



■ **Dimensions** (Unit : in. (mm))

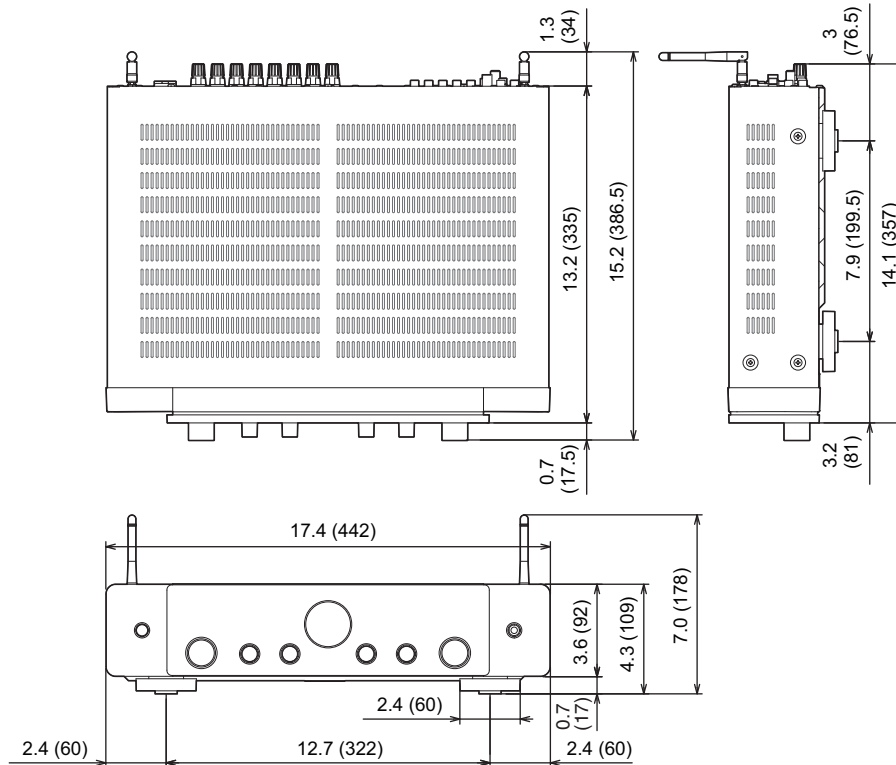

■ **Weight: 18.5 lb (8.4 kg)**





# Index

## Numerics

2.1-channel .....	30
3D .....	197
4K/8K .....	197

## A

AirPlay .....	90
All Zone Stereo .....	101
Audio formats .....	199, 202, 204, 205
Audio settings .....	129
Auto Standby .....	159

## B

Bluetooth device .....	60
Blu-ray Disc player .....	40, 54

## C

Cable TV .....	38
----------------	----

## D

Display .....	18
DVD player .....	40, 54

## E

ECO Mode .....	156
External control device .....	48

## F

Firmware Update .....	164
FM/AM antenna .....	44, 68
Front panel .....	16

## G

General settings .....	156
------------------------	-----

## H

HDCP .....	199
HDMI Control .....	104
HEOS Account .....	82, 155
HEOS Favorites .....	96

## I

Input Assign .....	140
Input settings .....	124, 140
Input source .....	53
Internet Radio .....	75

## M

M-DAX .....	129
Menu map .....	123
Muting .....	54

## N

NAS .....	77
Network settings .....	124

## P

Pairing .....	60, 61
PC .....	77
Protection circuit .....	209



**Q**

Queue ..... 56, 78, 85

**R**

Rear panel ..... 20

Remote control unit ..... 23

Resetting factory settings ..... 194

Resetting network settings ..... 195

**S**

Satellite tuner ..... 38

Set-top box ..... 38

Setup Assistant ..... 127

Sleep timer ..... 105

Smart select ..... 107

Sound mode ..... 102

Speaker connection ..... 28

Speaker settings ..... 144

Spotify ..... 93

**T**

Tips ..... 175

Troubleshooting ..... 176

TV ..... 35, 36

**U**

USB memory device ..... 43, 55

**V**

Video Select ..... 100

Video settings ..... 131

Volume ..... 54

**W**

Web control ..... 115

Wi-Fi settings ..... 148

Wired LAN ..... 46

Wireless LAN ..... 47

**Z**

ZONE2 ..... 118



**marantz**

3520 10924 00ASB

©2023 DEI Sales, Inc. All Rights Reserved.