

marantz

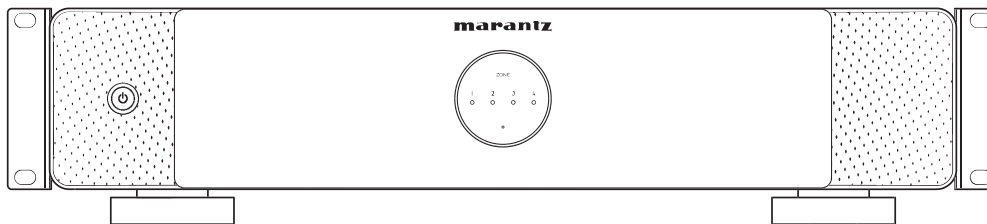

MODEL M4 | Multi-room Amplifier

Owner's Manual

Accessories	4
Part names and functions	5
Front panel	5
Rear panel	6
Placing	7
Mounting in a rack	7
Connecting	9
Connecting speakers (4 stereo zones)	10
Connecting to an external amplifier or AV receiver	13
Connecting a subwoofer	14
Connecting a USB flash drive	15
Trigger control	16
Connecting external devices	17
Connecting to network	18
Connecting a pre-amplifier (Power amplifier mode)	19
Switching to Power Amplifier Mode	20
Powering this unit	21
Getting the HEOS app	22
Setup	
<hr/>	
Adding the registration of HEOS Built-in devices in the HEOS app	23
Adding wired HEOS Built-in devices	23
Adding wireless HEOS Built-in devices	24
HEOS account	25

Playback

Playing from streaming music services	26
Selecting a room/device	26
Selecting the music track or station from music sources	27
Listening to the same music in multiple rooms	28
Grouping rooms	28
Ungrouping rooms	29
Grouping all rooms	30
Ungrouping all rooms	31
Listening to Internet Radio	32
Playing music stored on your mobile	32
Playing back files stored on a PC or NAS	32
Playing music from an external device	33
Playing music from a USB flash drive	33
AirPlay function	34
Playing songs from your iPhone, iPod touch, iPad or Mac	35
Playing songs from Windows PC	35
Play a song from your iPhone, iPod touch, iPad or Mac on multiple synced devices (AirPlay 2)	36
Spotify Connect function	37
Playing Spotify music with your speaker	37



Troubleshooting

Troubleshooting	38
This unit turns off and the protection Indicator flashes in red	39
Music cuts out or delays sometimes	39
I hear a delay when using the external input with my TV	40
Resetting this unit	40
Restoring this unit to factory defaults	40

Status LED

Status LED table	41
-------------------------	-----------

Appendix

Power management	45
Supported file types and codecs	46
Supported audio formats (Optical)	46
Trademark information	47
Specifications	48









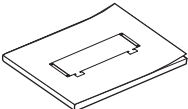

Thank you for purchasing this Marantz product.

To ensure proper operation, please read this owner's manual carefully before using the product.

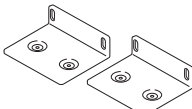
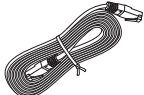
After reading this manual, be sure to keep it for future reference.

Accessories

Check that the following parts are included with the product.

 Quick Start Guide	 Safety Instructions	 Rack mount brackets	 Ethernet cable
 Power cord (for North America)	 Power cord (for Europe)	 Power cord (for UK)	 Power cord (for Australia)
 Power cord (for Japan)	 Power cord (for China)		



Part names and functions

Front panel

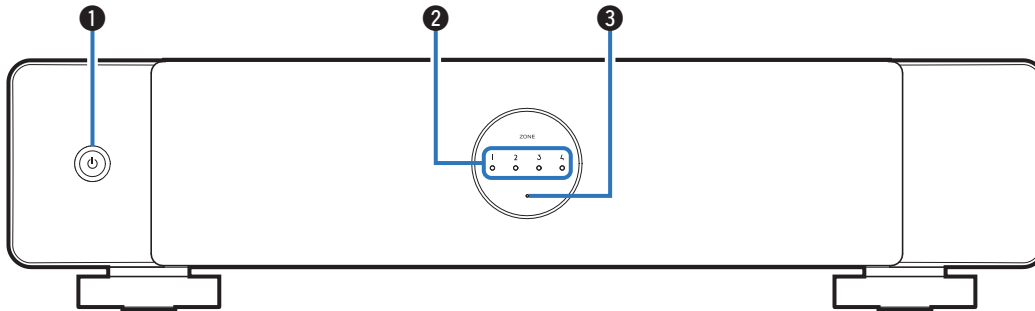

1 Power operation button (⏻)

Used to enter Deep Standby and return from them.

2 Zone indicators

Please refer to the “Status LED table” (📖 p. 41)

3 Protection indicator

This blinks when the protection circuit has operated. (📖 p. 39)



Rear panel

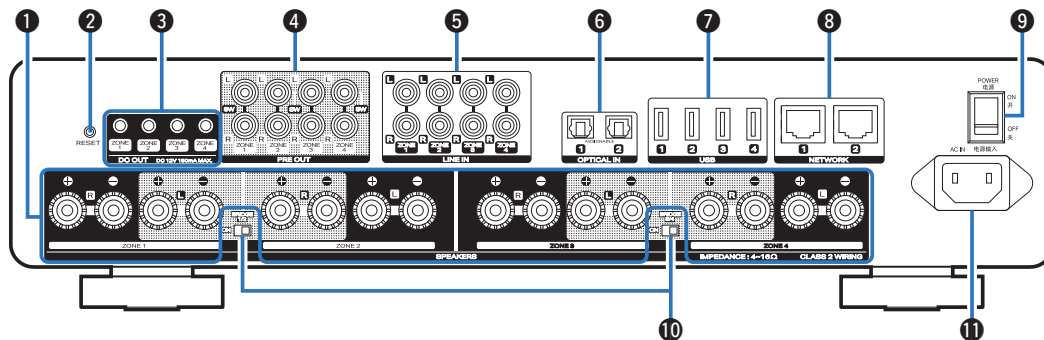

❶ Speaker terminals (SPEAKERS)

Used to connect speakers. (☞ p. 10)

❷ RESET button

Various settings are reset to the factory default values. (☞ p. 40)

❸ Trigger out jacks (DC OUT)

Used to connect devices equipped with a trigger function. (☞ p. 16)

❹ Analog output connectors (PRE OUT)

Used to connect external amplifiers. (☞ p. 13)

❺ Analog input connectors (LINE IN)

- Used to connect devices equipped with analog audio outputs. (☞ p. 17)
- Used to connect the pre-amplifier when using the unit as a power amplifier. (☞ p. 19)

❻ Digital input connectors (OPTICAL IN)

Used to connect devices equipped with digital audio outputs. (☞ p. 17)

❼ USB ports

Used to connect USB storage devices. (such as USB flash drives) (☞ p. 15)

❽ NETWORK connectors

Used to connect this unit to a wired Ethernet network. (☞ p. 23)

❾ Power switch (POWER)

❿ Bridge mode switches (BRIDGE)

Used to enable the amplifier bridge setting. (☞ p. 11)

⓫ AC inlet

Used to connect the power cord. (☞ p. 21)



Placing

You should place this unit in a convenient location near your speaker wires.

- This unit is not waterproof. Do not place it near any water source and do not leave it outside in the rain or snow.

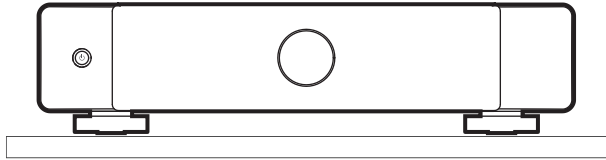

Mounting in a rack

Attach the included rack mount brackets to the sides of this unit if you want to mount this unit in a standard EIA equipment rack.

- 1 Remove the two screws on each side of this unit .**
- 2 Align the brackets with the screw holes and reattach the screws making sure they are secure.**

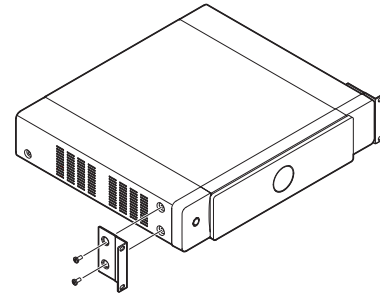

3 Remove the bottom foot of this unit using a screwdriver (not included).

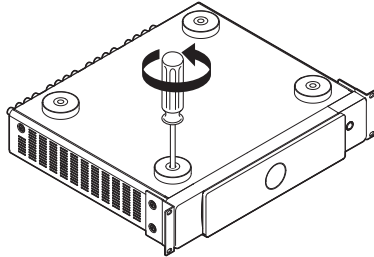

4 Attach this unit to the rack using the rack mount brackets.

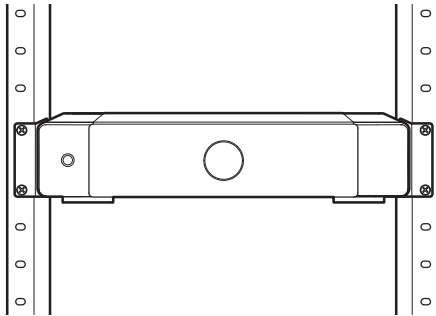

NOTE

- Do not cover the side of this unit. Remember, heat is dispersed from this unit's side surface.
- Set up the installation environment carefully. For example, take care to protect this unit from heat from other devices. If necessary, use forced ventilation. The surrounding conditions must meet the specifications described in "Specifications" (☞ p. 48).
- If this unit is not to be mounted in a rack, remove the rack mount brackets.



Connecting

This document describes the connection based on ZONE 1 as an example, ZONE 2 through to Zone 4 also have the same functions as ZONE 1.

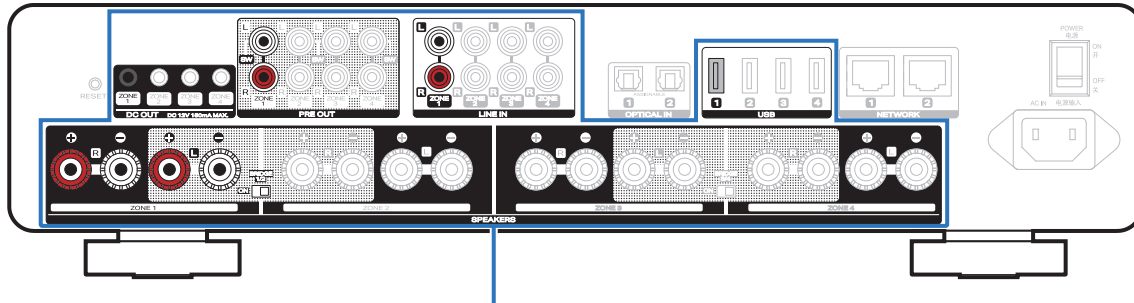

ZONE 1 - ZONE 4



Connecting speakers (4 stereo zones)

■ Connecting speakers

Carefully check the left (L) and right (R) channels and + (red) and – (black) polarities on the speakers being connected to this unit, and be sure to connect the channels and polarities correctly.

- 1 Peel off about 3/8 inch (10 mm) of sheathing from the tip of the speaker cable, then either twist the core wire tightly or terminate it.**



- 2 Turn the speaker terminal counterclockwise to loosen it.**



- 3 Insert the speaker cable's core wire to the hilt into the speaker terminal.**



- 4 Turn the speaker terminal clockwise to tighten it.**



NOTE

- Turn off the power switch of rear panel before connecting the speakers. Also, turn off any connected powered subwoofers.
- Connect so that the speaker cable core wires do not protrude from the speaker terminal. The protection circuit may be activated if the core wires touch the rear panel or if the + and – sides touch each other.
- Never touch the speaker terminals while the power cord is connected and power switch of rear panel is turned on. Doing so could result in electric shock.
- Use speakers with an impedance of 4 – 16 Ω/ohms. The protection circuit may be activated if speakers with an impedance other than specified are used.

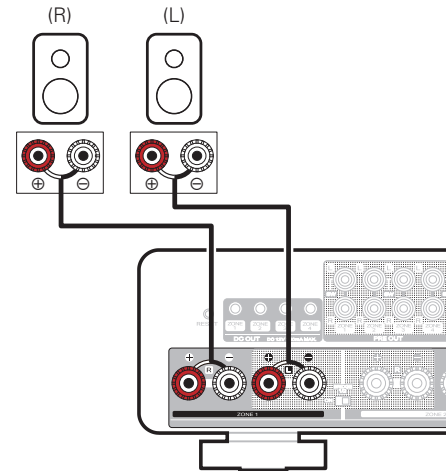

■ Connecting speakers (two bridged zones)

Larger output can be obtained by connecting using a bridged connection. You can combine the speaker terminals of ZONE 1 and ZONE 2 or ZONE 3 and ZONE 4 to form a bridge connection.

- 1 Turn off the power switch of rear panel.
- 2 Connect the left speaker to the Lch-side speaker terminal of ZONE 1 and the right speaker to the Rch-side speaker terminal of ZONE 2.



- You can also use the Lch-side speaker terminal of ZONE 3 and the Rch-side speaker terminal of ZONE 4.

- 3 Slide the BRIDGE 1/2 switch to the “ON” position.



- To connect the speaker terminals of ZONE 3 and ZONE 4 using the bridge connection, set BRIDGE 3/4 to “ON”.

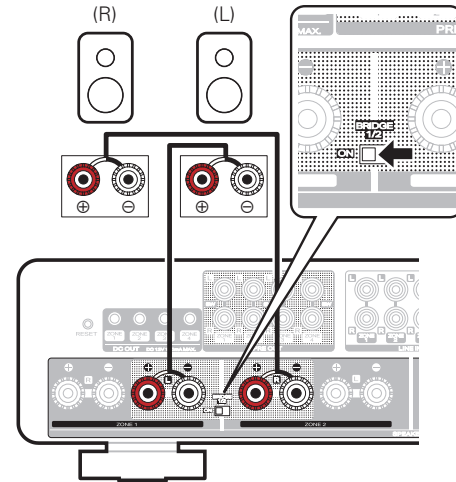

NOTE

- Turn off the power switch of rear panel before connecting the speakers. Also, turn off the subwoofer.
- Connect so that the speaker cable core wires do not protrude from the speaker terminal. The protection circuit may be activated if the core wires touch the rear panel or if the + and – sides touch each other.
- Never touch the speaker terminals while the power cord is connected and power switch of rear panel is turned on. Doing so could result in electric shock.
- Use speakers with an impedance of 4 – 16 Ω /ohms. The protection circuit may be activated if speakers with an impedance other than specified are used.
- In BRIDGE mode, one channel is output from one ZONE. In the example shown here, no signal is output from the speaker Rch of ZONE1 and Lch of ZONE2.
- ZONE 1 and ZONE 2 connected using a bridge connection operate as ZONE 1, and ZONE 3 and ZONE 4 connected using a bridge connection operate as ZONE 3.
- When the unit is set to bridge mode, you cannot select ZONE 2 and ZONE 4 in “My Devices” settings in the HEOS app.



Connecting to an external amplifier or AV receiver

Connect the PRE OUT output to an available input on your amplifier or AV receiver using the appropriate cables.

NOTE

- When connecting to the PRE OUT terminal of the unit, configure the following settings in “My Devices” in the HEOS app
 - Set Sub Out (L) to disable.
 - Set Preamp Out to enable.

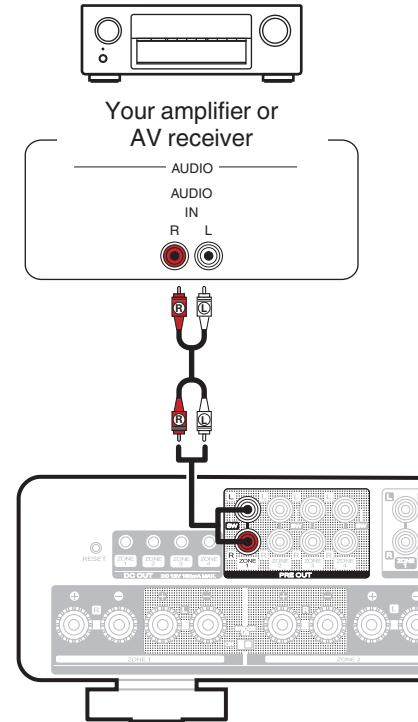

Connecting a subwoofer

Connect the PRE OUT“L” output to an input on your powered subwoofer or your subwoofer amplifier.

NOTE

- When connecting to the subwoofer of the unit, configure the following settings in “My Devices” in the HEOS app.
 - Set Sub Out (L) to enable.
 - Set Preamp Out to disable.
- You can configure the high and low pass filters on “My Devices” in the HEOS app.

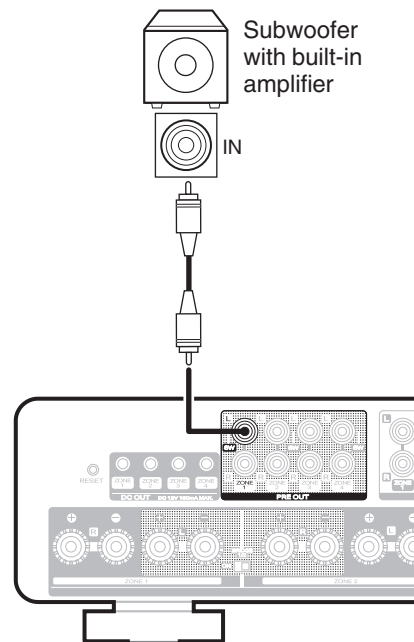

Connecting a USB flash drive

Connect a FAT32 or NTFS formatted USB flash drive containing digital music files to any available USB port.

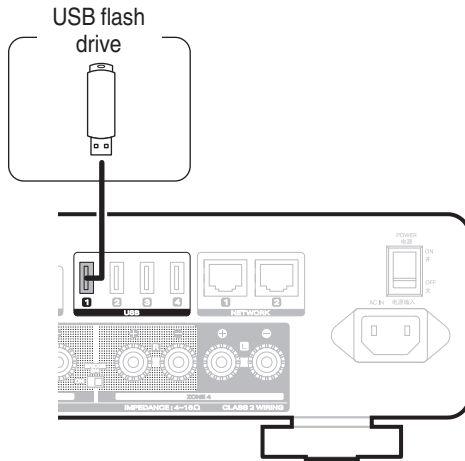

Trigger control

If the power amplifier connected to this unit has a trigger input connector, connect it to the trigger out jack (DC OUT) of this unit using a 3.5mm cable (not included). A signal up to 12 V/150 mA is output from the trigger out jack (DC OUT).

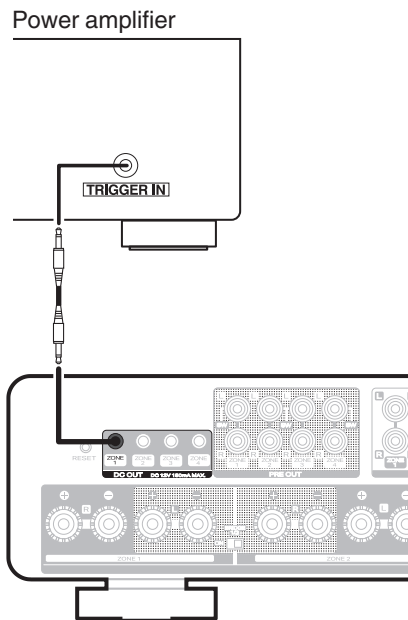

NOTE

- Use a monaural mini-plug cable for connecting the trigger out jacks (DC OUT). Do not use a stereo mini-plug cable.
- The trigger settings of the HEOS app must be set in order to use trigger control.



Connecting external devices

■ Connecting an audio playback device

Connect the LINE IN or OPTICAL IN input to an audio playback device (CD player, portable music player, etc...) using the appropriate cables.

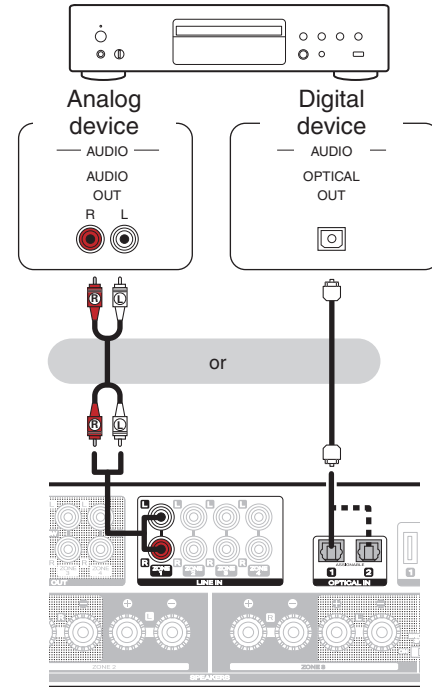

Connecting to network

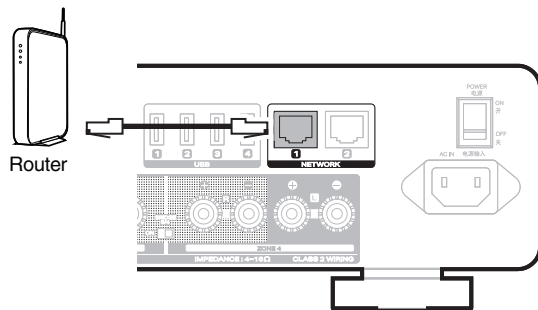

■ Daisy chain

You can use the second Ethernet connection to connect another MODEL M4 to your network.

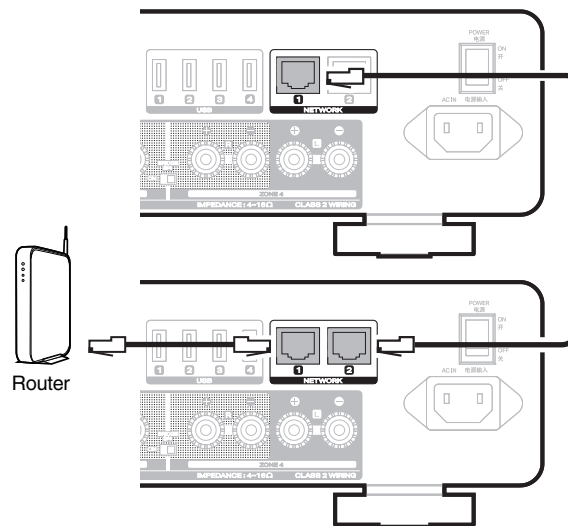

NOTE

- Each MODEL M4 contains four HEOS modules and therefore always counts as four devices towards the maximum number of 32 HEOS built-in devices supported on any one network. Up to 8 MODEL M4 units are supported on a single network.



Connecting a pre-amplifier (Power amplifier mode)

You can use the unit as a power amplifier by connecting a preamplifier. Connect the pre-amplifier outputs to the LINE IN inputs.



- In Power Amplifier Mode, the audio signal input to LINE IN ZONE 1 is output only from SPEAKER ZONE 1. The same is true for ZONE 2, ZONE 3 and ZONE 4.
- Switch to Power Amplifier Mode to use the unit as a power amplifier. (👉 p. 20)

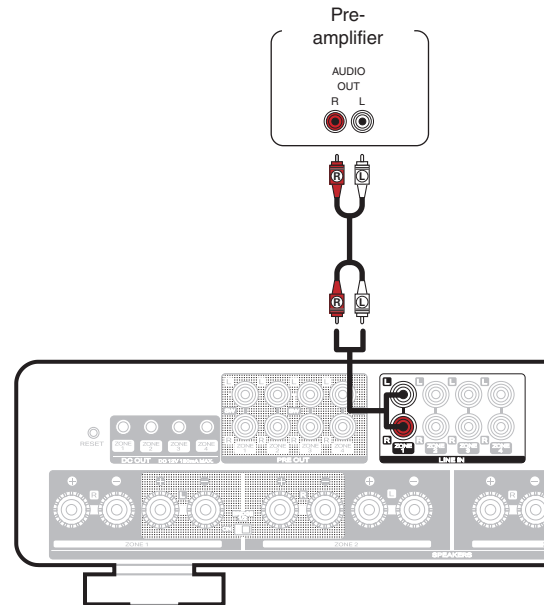

Switching to Power Amplifier Mode

Switch to Power Amplifier Mode to use the unit as a power amplifier.

- 1 While pressing the power operation button (⏻) on the front panel, turn on the power switch on the rear panel.
 - The protection indicator flashes 3 times.

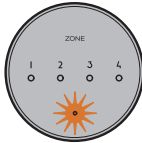

- All zones enter Power Amplifier Mode.
- In Power Amplifier Mode, the volume of the unit cannot be adjusted. Adjust the volume using the pre-amplifier.
- In Power Amplifier mode, the unit cannot be operated from the app.
- In Power Amplifier Mode, the unit does not automatically switch to Quick Start Mode. (🔧 p. 45) Press the power button on the unit.

■ Exiting Power Amplifier Mode.

- 1 While pressing the power button (⏻) on the front panel, turn on the power switch on the rear panel.
 - The protection indicator flashes 6 times.

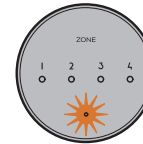

NOTE

- When exiting Power Amplifier Mode, the volume level of the unit will be set to 64 (of 100 steps). Adjust the volume before playing audio.



Powering this unit

NOTE

- Connect the appropriate power cord for your region between the back of this unit and a wall outlet and then switch the rear panel power switch to the ON position.

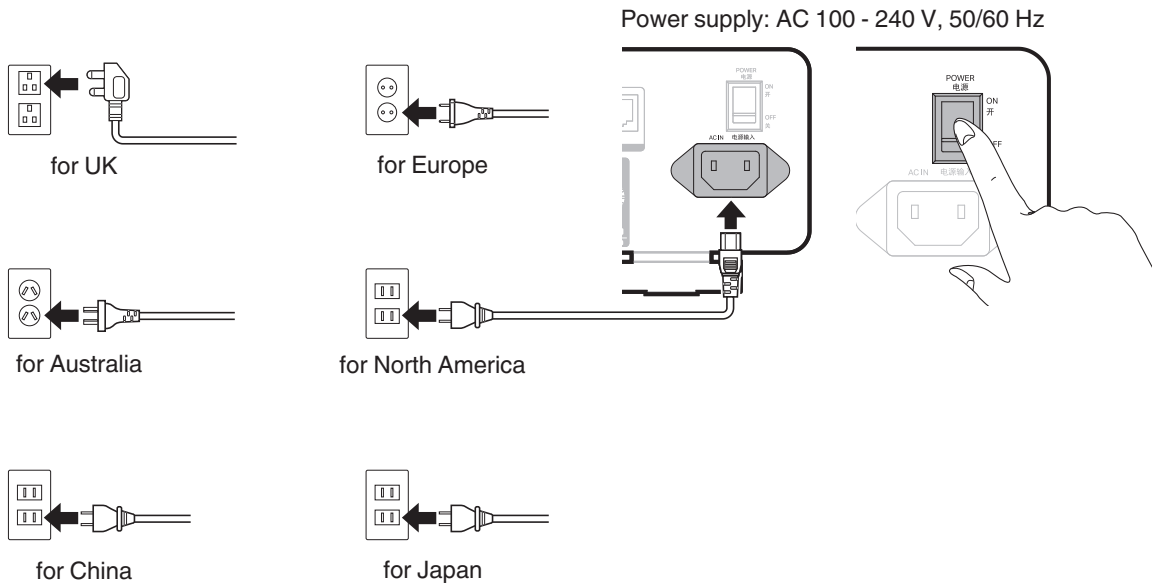

Getting the HEOS app

You can use many online music streaming services from the HEOS app. Depending upon your geographical location, there are several options to choose from.

Download the HEOS app for iOS or Android by searching App Store®, Google Play™ store or Amazon App Store for “HEOS”.



For the purpose of improvement, the specifications and design are subject to change without notice.



Adding the registration of HEOS Built-in devices in the HEOS app

The HEOS system is a true multiroom audio system that automatically synchronizes audio playback between multiple HEOS Built-in devices so that the audio coming from different rooms is perfectly in sync and always sounds amazing! You can easily add up to 32 HEOS Built-in devices to your HEOS system.

NOTE

- Each MODEL M4 contains four HEOS modules and therefore always counts as four devices towards the maximum number of 32 HEOS built-in devices supported on any one network. Up to 8 MODEL M4 devices are supported on a single network.

Adding wired HEOS Built-in devices

Just connect the HEOS built-in devices to your home network using an Ethernet cable and the HEOS built-in devices will appear on your HEOS app as a new room in the Rooms screen.

At your convenience, you can assign a name to the HEOS Built-in device to indicate which room you have it placed in.



- Use only a shielded STP or ScTP LAN cable which is easily available at electronics stores (CAT-5 or greater recommended).
- The normal shielded-type LAN cable is recommended. If a flat-type cable or unshielded-type cable is used, other devices could be affected by noise.
- Do not connect a NETWORK connector directly to the LAN port/Ethernet connector on your computer.



Adding wireless HEOS Built-in devices

You can add additional wireless HEOS Built-in devices to your HEOS system by selecting “Add Device” from the HEOS app’s settings menu and follow the instructions:

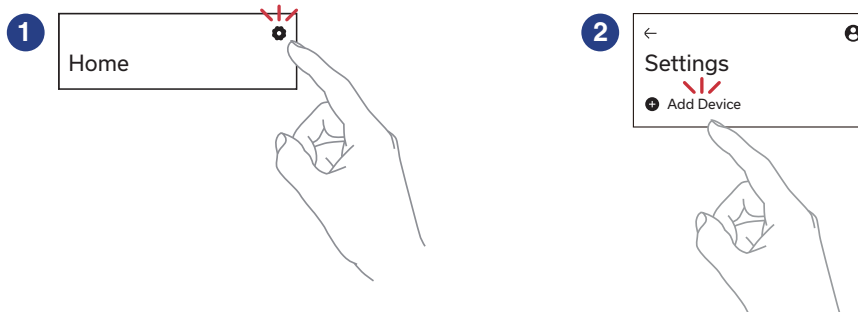

NOTE

- This unit can not be connected to a wireless network.



HEOS account

■ What is a HEOS account?

A HEOS account is a master account or “keychain” for managing all of your HEOS music services with one single username and password.



■ Why do I need a HEOS account?

With a HEOS account, you only need to enter your music services login names and passwords once. This allows you to easily and quickly use multiple controller apps on different devices. You just log into your HEOS account on any device and you will have access to all of your associated music services, play history and custom playlists, even if you are at a friend’s house listening to music on their HEOS system.

■ Signing up for a HEOS account

You will be instructed to signup for a HEOS account the first time you try to access any music service from the “Home” screen of the HEOS app.

■ Changing your HEOS account

- 1 Tap the “Home” tab.
- 2 Select the Settings  icon in the upper-right corner of the screen.
- 3 Select the HEOS Account  icon.
- 4 Change your location, change your password, delete your account or sign out of your account.



Playing from streaming music services

A music service is an online music company that provides access to vast music collections via free and/or paid subscriptions. Depending upon your geographical location, there are several options to choose from.

NOTE

- The HEOS app and brand is not affiliated with any manufacturer of any mobile device. Availability of music services may vary by region. Not all services may be available at time of purchase. Some services may be added or discontinued from time to time based on decisions of the music service providers or others.

Selecting a room/device

- 1 Tap the “Rooms” tab. Select “Marantz MODEL M4 Zone 1” if there are multiple HEOS built-in devices.



- Tap “Edit” at the top right to switch edit mode. You can change the displayed name.

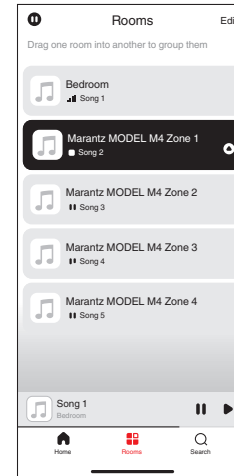

Selecting the music track or station from music sources

1 Tap the “Home” tab and select a music source.

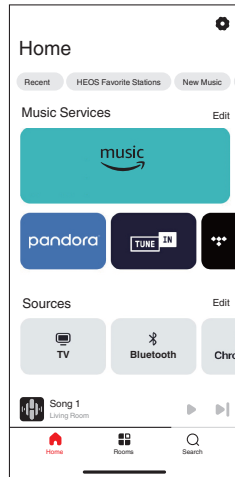

- All music services displayed may not be available in your location.

2 Browse the music to play.

After selecting a music track or radio station the app will automatically change to the “Now Playing” screen.

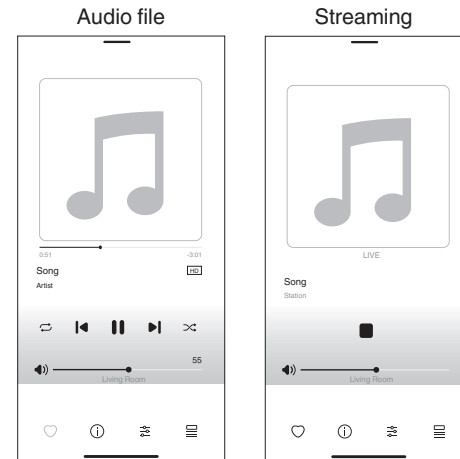

- The “Now Playing” banner appears on the “Home” screen, “Rooms” screen and “Search” screen. You can check the song currently playing and perform simple playback operations no matter which screen is displayed.



Listening to the same music in multiple rooms

This system is a true multi-room audio system. You can create one or more HEOS groups to automatically synchronize audio playback between multiple products with HEOS Built-in so that the music playing different rooms is perfectly in sync and always sounds amazing! You can easily add up to 32 products to your system in total. You can group up to 16 individual products to have them play the same song fully synchronized.

Grouping rooms

- 1 Press and hold your finger on room that is not playing music.**
- 2 Drag it into the room that is playing music and lift your finger.**
- 3 The two rooms will be grouped together into a single device group and both rooms will be playing the same music in perfect sync.**

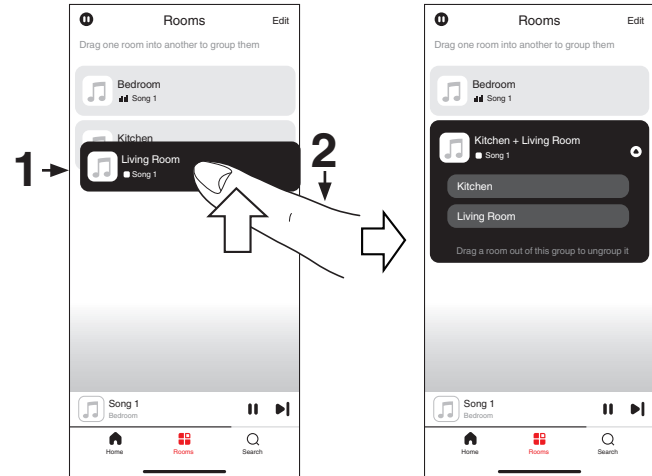

Ungrouping rooms

- 1 Press and hold your finger on room that you want to remove from the group.
- 2 Drag it out of the group and lift your finger.

NOTE

- You can not remove the first room that started playing the music before grouping.

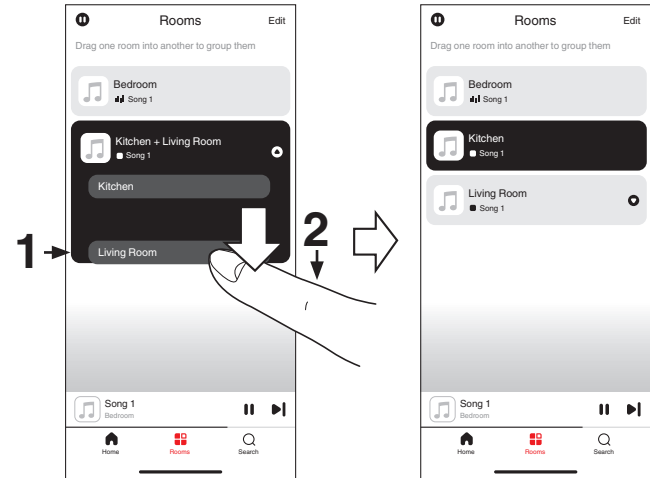

Grouping all rooms

You can easily group all rooms (up to 16 rooms) together by using a “pinch” gesture.

- 1** Place two fingers on the screen over the list of rooms.
- 2** Quickly pinch your two fingers together and release.
- 3** All of your rooms will be joined together and begin playing the same music in perfect sync.

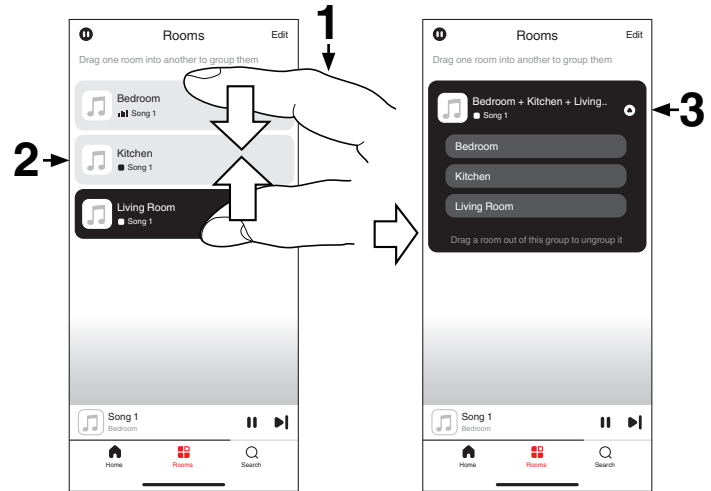

Ungrouping all rooms

You can easily ungroup all of your rooms by using a “spread” gesture.

- 1** Place two fingers close together on the screen over list of rooms.
- 2** Quickly spread your two fingers apart from each other and release.
- 3** All of your rooms will be ungrouped.

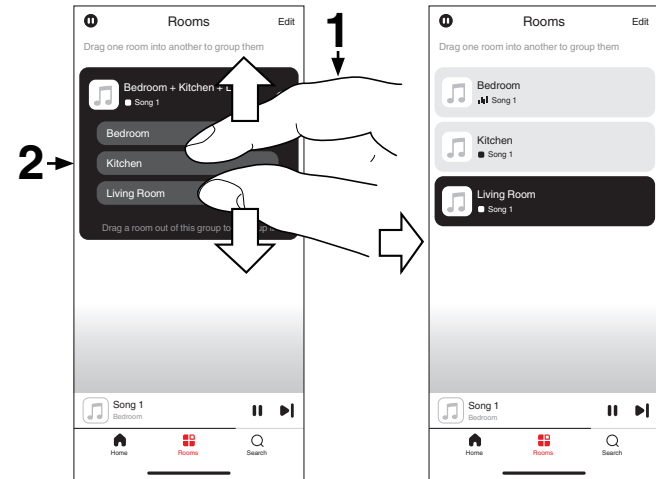

Listening to Internet Radio

The HEOS system includes access to more than 100,000 free internet radio streams from all corners of the globe via the TuneIn radio service. Just select the TuneIn logo from the “Home” screen and browse among the 100,000 stations neatly organized into popular categories and select a station that appeals to your mood.



- If you have a TuneIn account, tap “Edit” from the “Music Services” section of the “Home” screen, select “TuneIn” and sign in to the TuneIn service to access all “My Favorites” TuneIn stations.

NOTE

- The radio station database service may be suspended or be otherwise unavailable without notice.

Playing music stored on your mobile

- 1 Tap the “Home” tab.
- 2 Select “This Phone” from the “Sources” section.
- 3 Browse the local music on your phone and select something to play.

Playing back files stored on a PC or NAS

- 1 Tap the “Home” tab.
- 2 Select “Server” from the “Sources” section.
- 3 Select the name of your networked PC or NAS (Network Attached Storage) server.
- 4 Browse the music on your PC/NAS and select something to play.



Playing music from an external device

- 1** Connect an external device to the digital optical or analog RCA stereo input on the back of this unit.
- 2** Tap the “Home” tab.
- 3** Select “Inputs” from the “Sources” section.
- 4** Select the name of this unit and which input to which you connected the audio device in step 1.
- 5** Initiate playback on the audio device.

Playing music from a USB flash drive

- 1** Insert a FAT32 or NTFS formatted USB flash drive into the USB port on the rear panel of this unit.
- 2** Tap the “Home” tab.
- 3** Select “USB” from the “Sources” section.
- 4** Select the name of this unit.
- 5** Browse the music on your USB flash drive and select something to play.

NOTE

- It may take several minutes for the name of this unit to appear in the “USB” list if you have a large number of files on your USB flash drive.
- It is not possible to connect and use a computer via the USB port of this unit using a USB cable.



AirPlay function

Music files stored on your iPhone, iPod touch, iPad, Mac or Windows PC can be played on this unit via the network.



- Input source will be switched to “AirPlay” when AirPlay playback is started.
- You can stop AirPlay playback by choosing another input source.
- The screen may differ depending on the OS and software versions.

This device supports AirPlay 2®.

Sync multiple AirPlay 2 compatible devices/speakers for simultaneous playback.



Playing songs from your iPhone, iPod touch, iPad or Mac

You can stream music stored in your “iPhone/iPod touch/iPad/Mac” directly to this unit.

- 1 Connect your iPhone, iPod touch, iPad or Mac Wi-Fi to the same network as this unit.**
 - For details, see your device’s manual.
- 2 Open Apple Music and play music from your iPhone, iPod touch or iPad.**
- 3 Tap or click the AirPlay icon and select this unit.**

[Example] iOS 15 or macOS 13

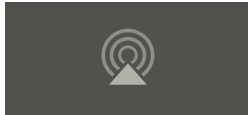

[Example] iOS 10



- You can also use AirPlay to stream music from other applications. Open the Control Center, tap or click the AirPlay icon, then select this unit.
- To use AirPlay, your iOS device must support iOS 10.0.2 or later, or OS X Mountain Lion 10.8 or later.

Playing songs from Windows PC

- 1 Install iTunes 10, or later, on a Windows PC that is connected to the same network as this unit.**
- 2 Start iTunes and click the AirPlay icon to select this unit.**

[Example] iTunes



- 3 Choose a song and click play in iTunes.**
The music will stream to this unit.



- For information about how to use iTunes, also see the Help for iTunes.



Play a song from your iPhone, iPod touch, iPad or Mac on multiple synced devices (AirPlay 2)

Songs from an iPhone, iPod touch, iPad or Mac can be synced with multiple AirPlay 2 supported devices for simultaneous playback.

1 Play the song on your iPhone, iPod touch, iPad or Mac.

AirPlay icon is displayed on the iPhone, iPod touch, iPad or Mac screen.

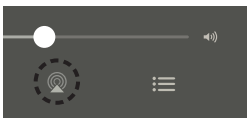

2 Tap or click the AirPlay icon and select this unit.

Displays a list of devices/speakers that can be played back on the same network.

- A circle is displayed to the right of AirPlay 2 compatible devices.

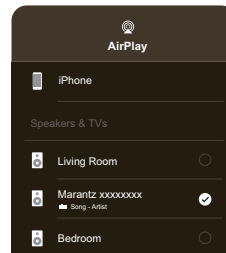

3 Select the devices/speakers you want to use.

- Multiple AirPlay 2 compatible devices can be selected.

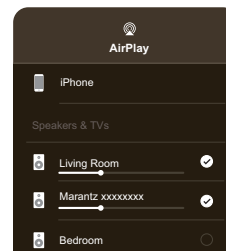

- To use AirPlay 2, your iOS device must support iOS 11.4 or later, or macOS Catalina or later.



Spotify Connect function

Spotify is all the music you'll ever need. Millions of songs available instantly. Just search for the music you love, or let Spotify play you something great. Spotify works on your phone, tablet, computer and home speakers. So you'll always have the perfect soundtrack for whatever you're doing. Now you can enjoy Spotify with your free account as well as a Premium account.

Use your phone, tablet or computer as a remote control for Spotify. Go to www.spotify.com/connect to learn how.

The Spotify software is subject to third party licenses found here: www.spotify.com/connect/third-party-licenses

Playing Spotify music with your speaker

Download the "Spotify App" onto your iOS or Android device beforehand.

- 1 Connect the Wi-Fi settings of the iOS or Android device in the same network as this unit.**
- 2 Launch the Spotify App.**
- 3 Play back a Spotify track.**
- 4 Tap the Spotify icon  to select the unit.**
The music will stream to this unit.



Troubleshooting

If a problem should arise, first check the following:

1. **Are the connections correct?**
2. **Is the set being operated as described in the owner's manual?**
3. **Are the other devices operating properly?**



- If steps 1 to 3 above do not improve the problem, restarting the device may improve the problem. Remove and re-insert the power cord of the unit.

If this unit does not operate properly, check the corresponding symptoms in this section.

If the symptoms do not match any of those described here, consult your dealer as it could be due to a fault in this unit. In this case, disconnect the power immediately and contact the store where you purchased this unit.



This unit turns off and the protection Indicator flashes in red

- The protection circuit has been activated due to a rise in temperature within this unit. Turn the power off, wait about an hour until this device cools down sufficiently, and then turn the power on again.
- Check the speaker connections. The protection circuit may have been activated because speaker cable core wires came in contact with each other or a core wire was disconnected from the connector and came in contact with the rear panel of this device. After unplugging the power cord, take corrective action such as firmly re-twisting the core wire or taking care of the connector, and then reconnect the wire. (👉 p. 10)
- Depending on the speakers that are connected, the protection circuit may activate and the power may be turned off when music is played at a high volume. (The protection Indicator flashes in red) In this case, please apply the “Volume Limit” setting on “My Devices” in the HEOS app.

Music cuts out or delays sometimes

- Make sure your Internet connection is operating correctly. If you are sharing your network with other users or devices, they may be using most of your bandwidth (especially if they are streaming video).



I hear a delay when using the external input with my TV

- If you are connecting the External input with your cable or satellite box for enjoying TV audio through multiple HEOS built-in devices, you may hear a delay between when you see someone speak and when you hear the audio. This is because the HEOS system must buffer the audio before it sends it out to the HEOS built-in devices so that it arrives at all devices at the same time.
- You can avoid this delay by listening only to the device which is directly connected to the set top box.

Resetting this unit

- Resetting this unit will clear out EQ, and name but retain it's current software. You will have to use Settings->Add Device to reconnect this unit to your home network before it can be used. To reset this unit, press the RESET button on the back and hold it in until the Zone LED begins to flash amber.

Restoring this unit to factory defaults

- Restoring this unit to its factory defaults will clear all of the settings and restore the original software which was installed at the factory.



NOTE

- All settings will be erased and the software will likely be downgraded!
To restore this unit to the factory defaults, turn off the power switch of rear panel. Press the RESET button on the back, turn on the power switch of rear panel, and hold it in until the Zone LED begins to flash amber.



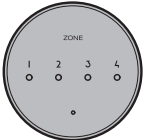

Status LED table

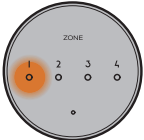



The LEDs on the front panel change to indicate the current status.

Status	Front LED action	Description
Deep Standby Mode	 <p>(off)</p>	Power is off, or this unit is in Deep Standby Mode. (👉 p. 45)
Quick Start Mode (User selectable)	 <p>(dimmed solid)</p>	This unit is in Quick Start Mode (Connected to your network). (👉 p. 45)
	 <p>(dimmed solid)</p>	This unit is in Quick Start Mode (Not connected to your network). (👉 p. 45)







Status	Front LED action	Description
Power on	 <p>(blink)</p>	This unit is starting up or connecting to the network.
	 <p>(solid)</p>	This unit is connected to the network.
	 <p>(solid)</p>	This unit is unable to connect to the network. Try to connect this unit again.



Status	Front LED action	Description
Volume setting	 <p>(quick blink)</p>	Volume is being adjusted.
	 <p>(slow blink)</p>	This unit is muted.
Firmware update	 <p>(blink)</p>	Firmware is being updated.
	 <p>(slow blink (Not fade))</p>	There is a firmware error. Check your Internet connection quality, relaunch the app, then try to update the firmware again.



Status	Front LED action	Description
Error	 <p data-bbox="448 331 512 353">(solid)</p>	<p data-bbox="644 225 1493 297">There was a setup error. Check your usage environment, then follow the correct procedure to try setup again. If the error occurs again, restore factory settings and try setup again. (👉 p. 40)</p>
	 <p data-bbox="427 533 533 555">(fast blink)</p>	<p data-bbox="644 437 1461 482">There is a hardware error. Unplug the power cord, wait about 30 seconds, then plug the power cord back in.</p>
Reset	 <p data-bbox="427 731 533 753">(fast blink)</p>	<p data-bbox="644 650 983 673">Factory settings have been restored.</p>
Power Amplifier Mode	 <p data-bbox="432 932 525 955">(3 blinks)</p>	<p data-bbox="644 846 1072 869">The unit was started in Power Amplifier Mode.</p>



Power management

■ Deep Standby

To save power, the device will automatically enter “Deep Standby Mode” whenever there is no playback for 20 minutes. Power indicator will turn off during Deep Standby. To “wake” this unit from Deep Standby, you must press the standby button which will immediately turn on power indicator.

Please note that HEOS and other network connections cannot be operated until reconnected after bootup.

■ Off

To completely turn off the power to the device you must switch to OFF of power switch on rear panel.

■ Quick Start Mode (Optional)

To save boot up time, the device can be put into a “Quick Start Mode”. In the HEOS App, go to the “My Devices” and then select “Power Saving” and select “Quick Start”. The wired connections remain on while in Quick Start Mode.

Please note that this setting will use more power.



Supported file types and codecs

Sampling frequency	Bit length	File extension	Codec	Bit rates
32/44.1/48/88.2/96/176.4/192 kHz	16/24 bit	wav	PCM	–
32/44.1/48 kHz	16 bit	mp3	MPEG-1 Audio Layer 3 CBR/VBR	32 - 320 kbps
32/44.1/48 kHz	16 bit	m4a aac	AAC-LC	48 - 320 kbps
32/44.1/48 kHz	16 bit	wma	wma9 CBR	CBR:48 - 192 kbps
44.1/48/88.2/96/176.4/192 kHz	16/24 bit	flac	flac	–
44.1/48/88.2/96/176.4/192 kHz	16/24 bit	m4a	ALAC	–
2.8/5.6 MHz	1 bit	dff dsf	DSDIFF DSF	–

NOTE

- For USB flash drive, the limited numbers of folders and files that can be played back on this unit are as follows.
 - Number of folder directory levels: 8 levels (The limited number includes the root folder.)
 - Number of folders: 500
 - Number of files: 5000 (The allowable number of files may differ according to the USB flash drive capacity and the file size.)
- Files protected by DRM, such as Apple's Fairplay DRM, are not supported.
- If you select a music source with a high bit rate or high resolution, it is set to the appropriate level by codec before being output.
- The ALAC decoder is distributed under the Apache License, Version 2.0 (<http://www.apache.org/licenses/LICENSE-2.0>)

Supported audio formats (Optical)

2-channel Linear PCM:2-channel, 32 kHz – 192 kHz, 16/20/24 bit

Bitstream:Dolby Digital



Trademark information



Google Play and the Google Play logo are trademarks of Google LLC.



App Store® is registered in the U.S. and other countries.



Manufactured under license from Dolby Laboratories. Dolby, Dolby Audio, and the double-D symbol are trademarks of Dolby Laboratories Licensing Corporation.



Apple, AirPlay, iPad, iPad Air, iPad Pro, iPhone and Mac are trademarks of Apple Inc., registered in the U.S. and other countries.

The trademark "iPhone" is used in Japan with a license from Aiphone K.K.

Use of the Works with Apple badge means that an accessory has been designed to work specifically with the technology identified in the badge and has been certified by the developer to meet Apple performance standards.

ROON READY

Being Roon Ready means that Marantz uses Roon streaming technology, for an incredible user interface, simple setup, rock-solid daily reliability, and the highest levels of audio performance, without compromise.



Specifications

■ Audio section

- Power amplifier

Rated output:

(Normal operation)

8-channel driving

100 W + 100 W (8 Ω /ohms, 20 Hz – 20 kHz with 0.05 % T.H.D. LPF 20 kHz)

125 W + 125 W (4 Ω /ohms, 1 kHz with 0.05 % T.H.D.)

(Bridge operation)

4-channel driving

200 W + 200 W (4 Ω /ohms, 1 kHz with 0.05 % T.H.D.)

Output connectors:

(Normal operation)

4 – 16 Ω /ohms

(Bridge operation)

4 – 16 Ω /ohms

S/N (IHF-A):

OPTICAL IN: 103 dB

LINE IN: 100 dB

Frequency response:

20 Hz - 40 kHz \pm 3 dB

- Analog (LINE IN)

Input sensitivity/impedance:

200 mV/20 k Ω /kohms

Maximum allowable input level:

2.5 V



■ General

Operating temperature:	41 °F - 95 °F (5 °C - 35 °C)
Power supply:	AC 100 - 240 V, 50/60 Hz
Power consumption:	265 W
Power consumption in Deep Standby Mode:	0.5 W
Power consumption in Quick Start Mode:	20 W (User selectable)



■ Dimensions (Unit : in. (mm))

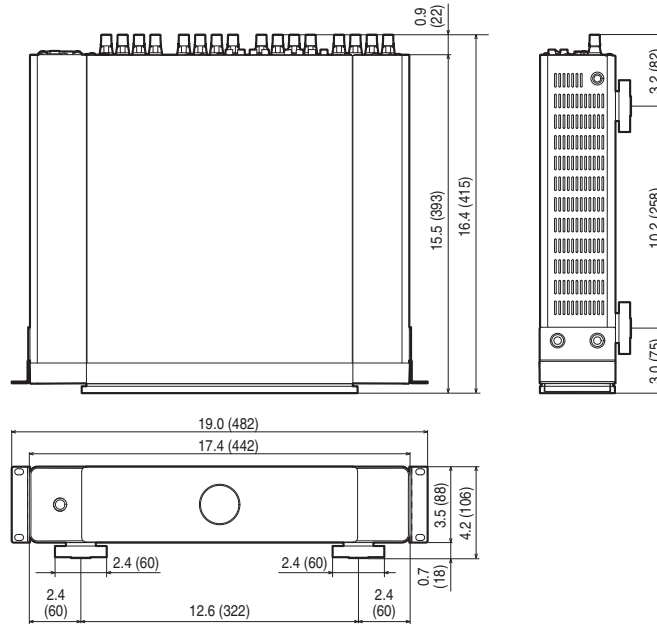

■ Weight :

18 lbs 1 oz (8.2 kg) (with brackets)

17 lbs 10 oz (8.0 kg) (w/o brackets)

For the purpose of improvement, the specifications and design are subject to change without notice.



marantz

3520 11005 00ASB

©2024 Masimo. All Rights Reserved.