

marantz

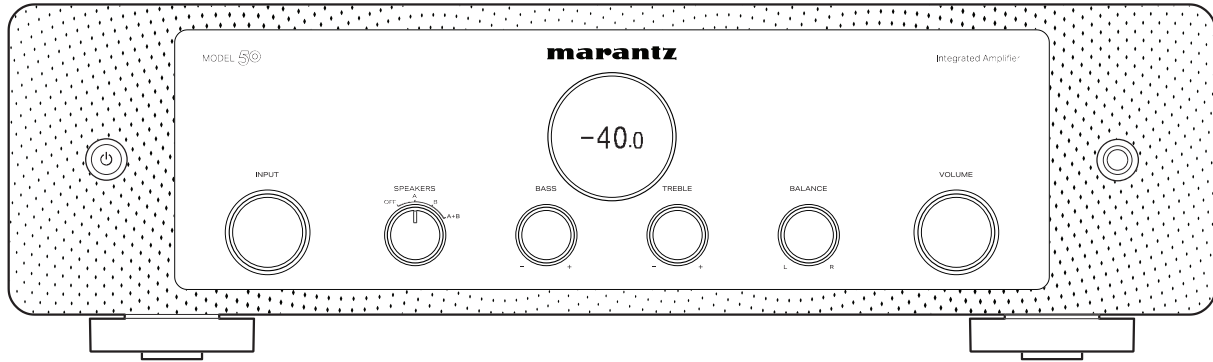

MODEL 50 | Integrated Amplifier

Owner's Manual

Accessories	4
Inserting the batteries	5
Operating range of the remote control unit	5
Part names and functions	6
Front panel	6
Rear panel	8
Remote control unit	10
Connections	
Connecting speakers	14
Speaker A/B connection	16
Bi-wiring connection	17
Subwoofer connection	18
Connecting a playback device	19
Connecting a recording device	20
Connecting a pre-amplifier or power amplifier	21
Connecting devices with remote control connectors	22
Performing operations by RC on this unit without visual contact	22
Remotely connecting Marantz audio devices	22
Connecting the power cord	24

Playback

Turning the power on	26
Switching the power to standby	26
Selecting the speakers for audio output	27
Selecting the input source	27
Adjusting the volume	27
Turning off the sound temporarily (Muting)	28
Adjusting the tone and balance	28
Playback in source direct mode	28
Playing CDs	28
Using this unit as a power amplifier	29
Recording	29



Settings

Setting the display's brightness	31
Setting the Auto Standby mode	32
Setting remote control codes	33
Setting remote control codes for the remote control	34
Setting remote control codes for the main unit	34

Tips

Tips	36
Troubleshooting	37
Power does not turn on / Power is turned off	38
Operations cannot be performed through the remote control unit	40
Display on this unit shows nothing	41
No sound comes out	41
Desired sound does not come out	42
Sound is interrupted or noise occurs	43

Appendix

Explanation of terms	44
Specifications	45
Index	47









Thank you for purchasing this Marantz product.

To ensure proper operation, please read this owner's manual carefully before using the product.

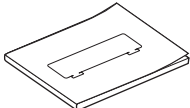
After reading this manual, be sure to keep it for future reference.

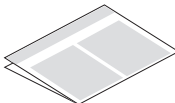
Accessories

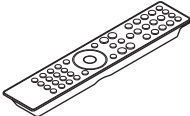
Check that the following parts are included with the product.

 Quick Start Guide	 Safety Instructions	 Warranty (for North America model only)	 Power cord
 Remote control unit (RC003PMND)	 2× R03/AAA batteries		



Inserting the batteries

- 1 Remove the rear lid in the direction of the arrow and remove it.

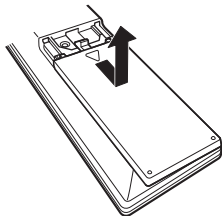

- 2 Insert two batteries correctly into the battery compartment as indicated.

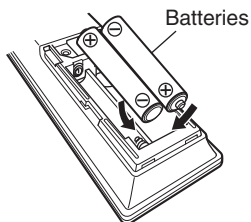

- 3 Put the rear lid back on.

NOTE

- To prevent damage or leakage of battery fluid:
 - Do not use a new battery together with an old one.
 - Do not use two different types of batteries.
- Remove the batteries from the remote control unit if it will not be in use for long periods.
- If the battery fluid should leak, carefully wipe the fluid off the inside of the battery compartment and insert new batteries.

Operating range of the remote control unit

Point the remote control unit at the remote sensor when operating it.

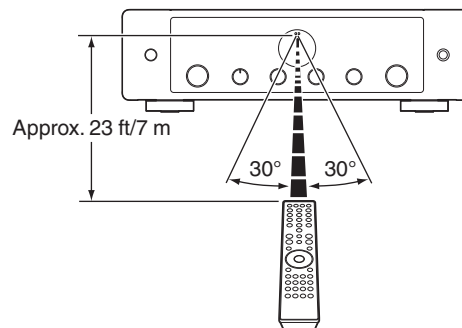

Part names and functions

Front panel

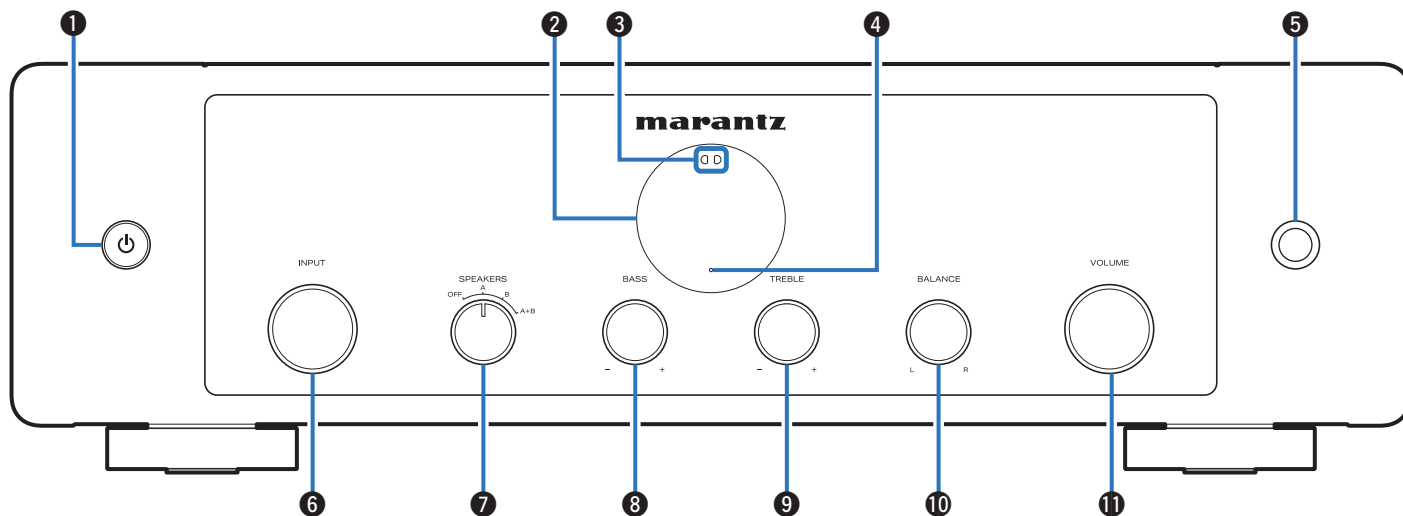

For details, see the next page.

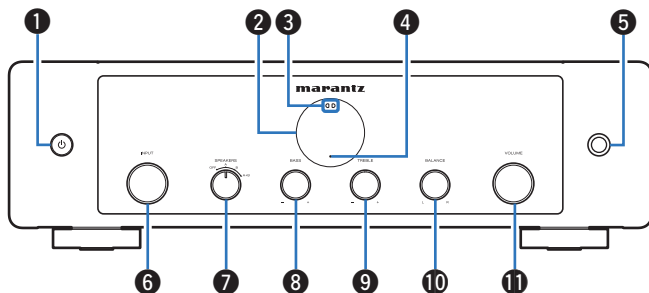

**1 Power \odot button**

This turns the power on/off (standby). (☞ p. 26)

2 Display

This displays various pieces of information.

3 Remote control sensor

This receives signals from the remote control unit. (☞ p. 5)

4 Protection circuit indicator

This blinks when the protection circuit has operated. (☞ p. 38)

5 Headphones jack

Used to connect headphones.

Turn the SPEAKERS selector knob on the main unit to turn off speaker output when using headphones. (☞ p. 27)

NOTE

- To prevent hearing loss, do not raise the volume level excessively when using headphones.

6 INPUT selector knob

This selects the input source. (☞ p. 27)

7 SPEAKERS selector knob

This selects the speaker for audio output. (☞ p. 27)

8 BASS control knob

This setting adjusts the volume level for the bass. (☞ p. 28)

9 TREBLE control knob

This setting adjusts the volume level for the treble. (☞ p. 28)

10 BALANCE control knob

This adjusts the balance of the volume output from the left and right speakers. (☞ p. 28)

11 VOLUME knob

This adjust the volume level. (☞ p. 27)



- 8, 9 and 10 can be adjusted when source direct mode is off. (☞ p. 28)



Rear panel

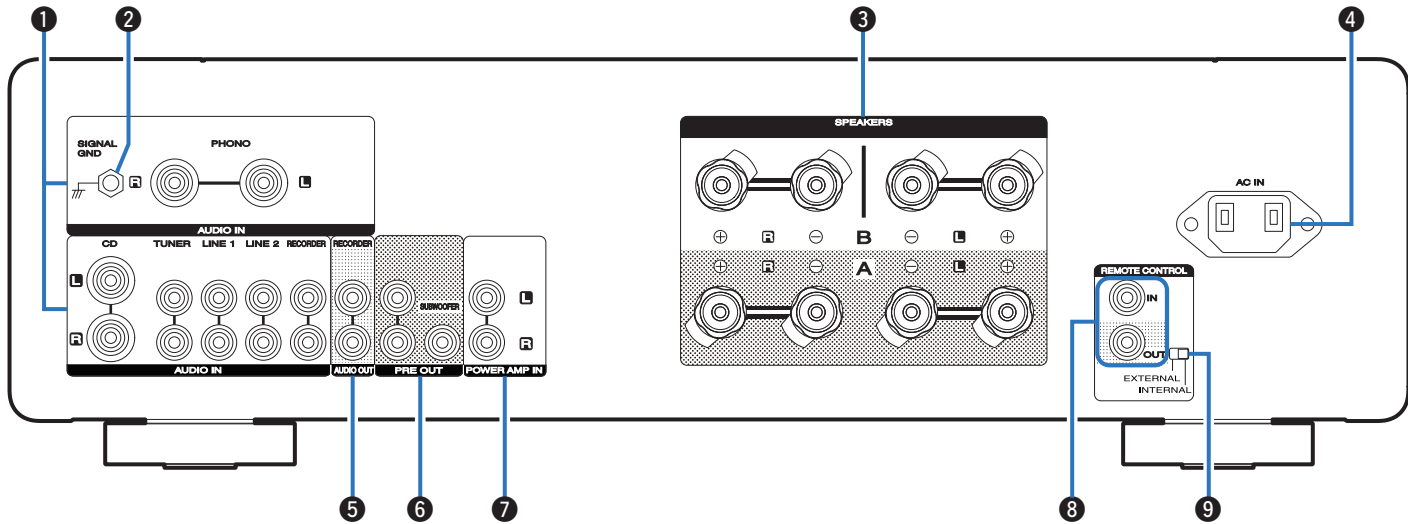

For details, see the next page.



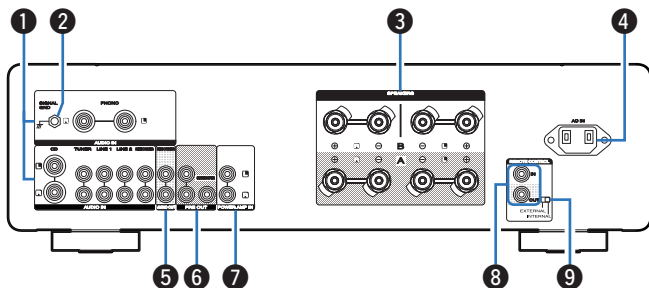

1 Analog audio input connectors (AUDIO IN)

Used to connect devices equipped with analog audio output connectors.

- “Connecting a playback device” (👉 p. 19)
- “Connecting a recording device” (👉 p. 20)

2 SIGNAL GND terminal

Used to connect the ground wire of a turntable. (👉 p. 19)

3 Speaker terminals (SPEAKERS)

Used to connect speakers. (👉 p. 14)

4 AC inlet (AC IN)

Used to connect the power cord. (👉 p. 24)

5 AUDIO OUT connectors (RECORDER)

Used to connect the input connector of a recorder. (👉 p. 20)

6 PRE OUT connectors

Use this to add such equipment as a power amplifier or subwoofer.

- “Subwoofer connection” (👉 p. 18)
- “Connecting a pre-amplifier or power amplifier” (👉 p. 21)



- When connecting a subwoofer, also consult the subwoofer instruction manual.

7 Power amplifier connectors (POWER AMP IN)

Used to connect a pre-amplifier when this unit is used as a power amplifier. (👉 p. 21)

8 Remote control input/output connectors (REMOTE CONTROL)

Used to connect to a Marantz audio device that is compatible with the remote control function. (👉 p. 22)

9 EXTERNAL/INTERNAL switch

Turn this switch to “EXTERNAL” to operate the unit by pointing the remote control at the audio device connected to this unit using the remote control connection. (👉 p. 22)



Remote control unit

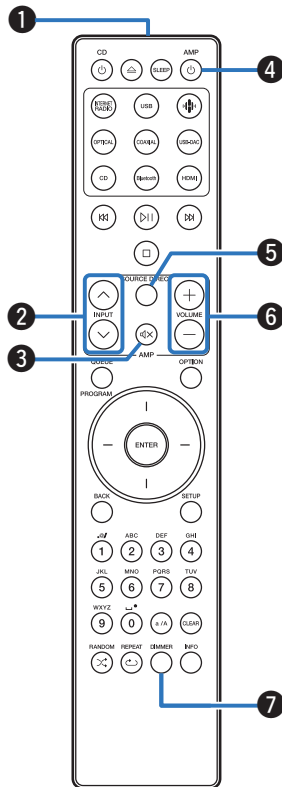

The remote control provided with this unit can control a Marantz Network CD player.

- “Network CD player operations” (☞ p. 11)

■ Operating this unit

1 Remote control signal transmitter

This transmits signals from the remote control unit. (☞ p. 5)

2 INPUT buttons (▲▼)

This selects the input source. (☞ p. 27)

3 Mute button (🔇)

This mutes the output audio. (☞ p. 28)

4 Power (AMP) button

- This turns the power on/off (standby). (☞ p. 26)
- This turns auto standby mode on/off. (☞ p. 32)

5 SOURCE DIRECT button

This turns source direct mode on/off. (☞ p. 28)

6 VOLUME buttons (±)

These adjust the volume level. (☞ p. 27)

7 DIMMER button



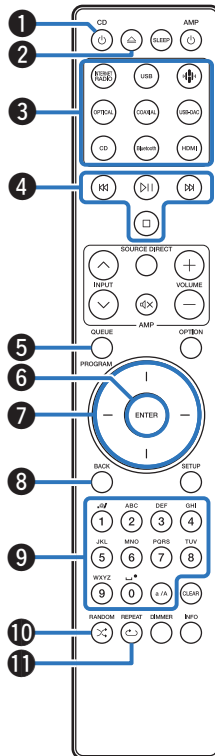

Adjust the display brightness of this unit. (☞ p. 31)





■ Network CD player operations

A Marantz Network CD player can be operated.

- 1 Power (CD ) button
- 2 Disc tray open/close button ()
- 3 Input source select buttons
- 4 System buttons
- 5 QUEUE button
PROGRAM button
- 6 ENTER button
- 7 Cursor buttons
- 8 BACK button
- 9 Number/letter buttons (0 – 9, a/A)
- 10 RANDOM button ()
- 11 REPEAT button ()



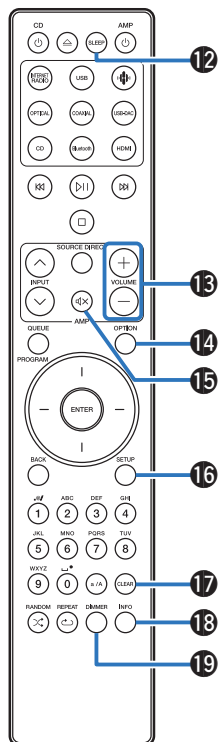

12 SLEEP button

13 VOLUME buttons (+/-)

14 OPTION button

15 Mute button (M)

16 SETUP button

17 CLEAR button

18 Information button (INFO)

19 DIMMER button



- The remote control may not operate some products.
- 18 and 15 only work when the remote control code is set to Network CD player operation mode. See the instruction manual of your Marantz Network CD player for details.



■ Contents

Connecting speakers	14
Connecting a playback device	19
Connecting a recording device	20
Connecting a pre-amplifier or power amplifier	21
Connecting devices with remote control connectors	22
Connecting the power cord	24

NOTE

- Do not plug in the power cord until all connections have been completed.
- Do not bundle power cords together with connection cables. Doing so can result in humming or noise.

■ Cables used for connections

Provide necessary cables according to the devices you want to connect.

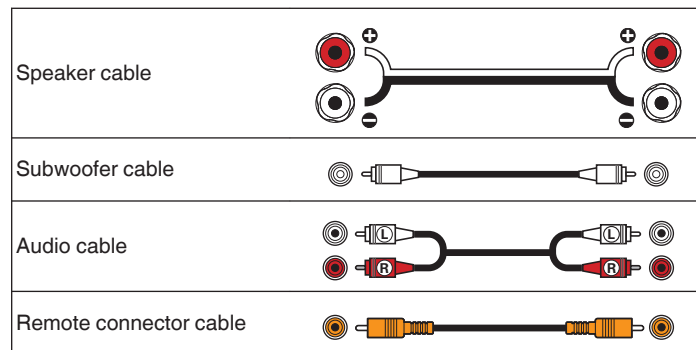

Connecting speakers

NOTE

- Disconnect this unit's power plug from the power outlet before connecting the speakers.
- Connect so that the speaker cable core wires do not protrude from the speaker terminal. The protection circuit may be activated if the core wires touch the rear panel or if the + and - sides touch each other. ("Protection circuit" (🔌 p. 44))
- Never touch the speaker terminals while the power cord is connected. Doing so could result in electric shock.
- Use speakers with impedances within the ranges shown below to suit how they are used.

Speaker terminals used on this unit	No. of connected speakers	Speaker Impedance
SPEAKERS A (Standard connection)	2 (one set)	4 – 16 Ω/ohms
SPEAKERS B	2 (one set)	4 – 16 Ω/ohms
SPEAKERS A and SPEAKERS B	4 (two sets)	8 – 16 Ω/ohms
SPEAKERS A and SPEAKERS B (Bi-wiring connection)	2 (one set)	4 – 16 Ω/ohms

■ Connecting the speaker cables

Carefully check the left (L) and right (R) channels and + (red) and - (white) polarities on the speakers being connected to this unit, and be sure to connect the channels and polarities correctly.

- 1 Peel off about 3/8 inch (10 mm) of sheathing from the tip of the speaker cable, then either twist the core wire tightly or terminate it.**



- 2 Turn the speaker terminal counterclockwise to loosen it.**

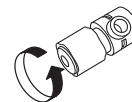

- 3 Insert the speaker cable's core wire to the hilt into the speaker terminal.**

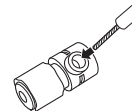

4 Turn the speaker terminal clockwise to tighten it.

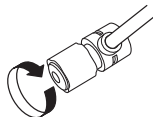

Spade lug connector



When using a banana plug

Tighten the speaker terminal firmly before inserting the banana plug.

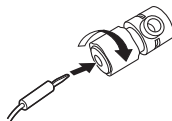

Speaker A/B connection

This unit is equipped with two sets of speaker terminals (SPEAKER A and SPEAKER B). One set of speakers can be connected to each set of terminals, and a total of two sets of speakers can be connected.

The same signal is output from the SPEAKERS A and SPEAKERS B terminals.

When only one set of speakers is to be connected, use either the SPEAKERS A or SPEAKERS B terminals.

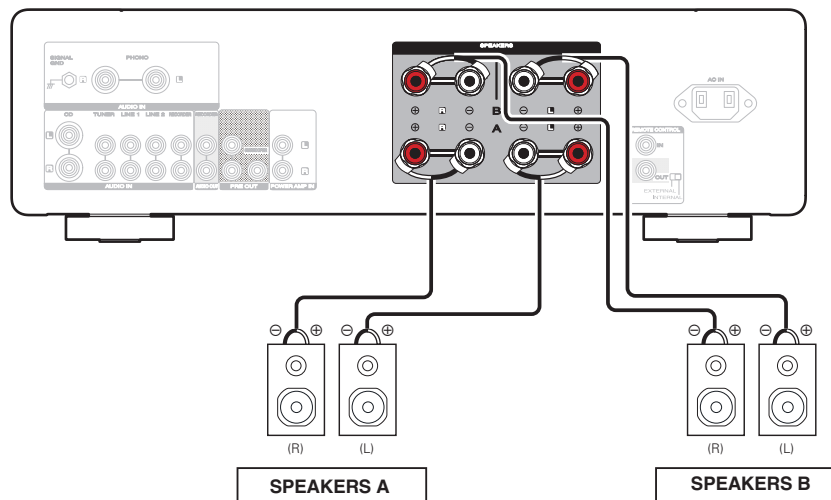

Bi-wiring connection

This connection limits the effects of signal interference between the high range speakers (tweeters) and low range speakers (woofers), allowing you to enjoy high quality playback.

When bi-wiring with bi-wireable speakers, connect the mid and high range terminals to SPEAKERS B (or SPEAKERS A), the low range terminals to SPEAKERS A (or SPEAKERS B).

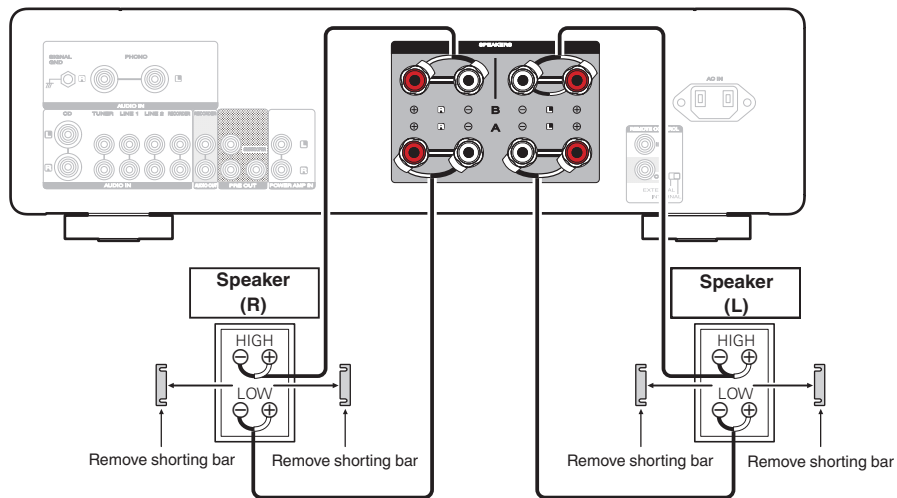

Subwoofer connection

Use a subwoofer cable to connect the subwoofer.

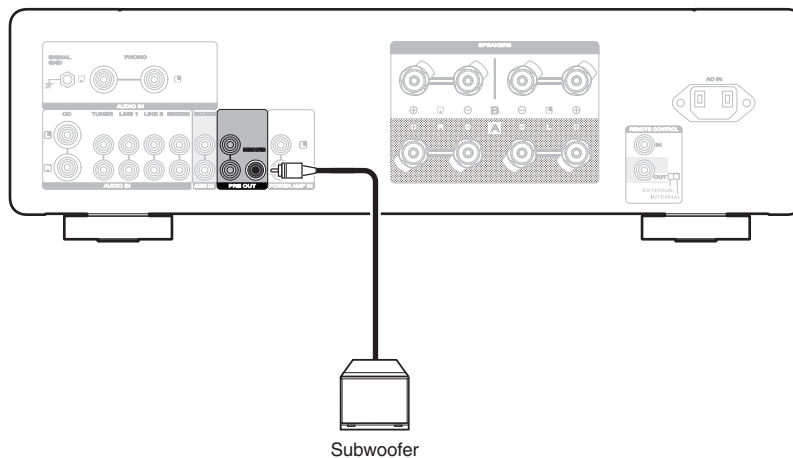

- The subwoofer volume is linked to the Speaker A volume.
- This unit does not output to the subwoofer when not set to output audio from the SPEAKERS A terminal. (☞ p. 27)



Connecting a playback device

You can connect turntables, tuners, Blu-ray disc players, network audio players and CD players to this unit.

This unit is compatible with turntables equipped with a moving magnet (MM) phono cartridge. When you connect to a turntable with a low output moving coil (MC) cartridge, use a commercially available MC head amp or a step-up transformer.

If you set this unit's input source to "PHONO" and you accidentally increase the volume without having a turntable connected, you may hear a hum noise from the speakers.

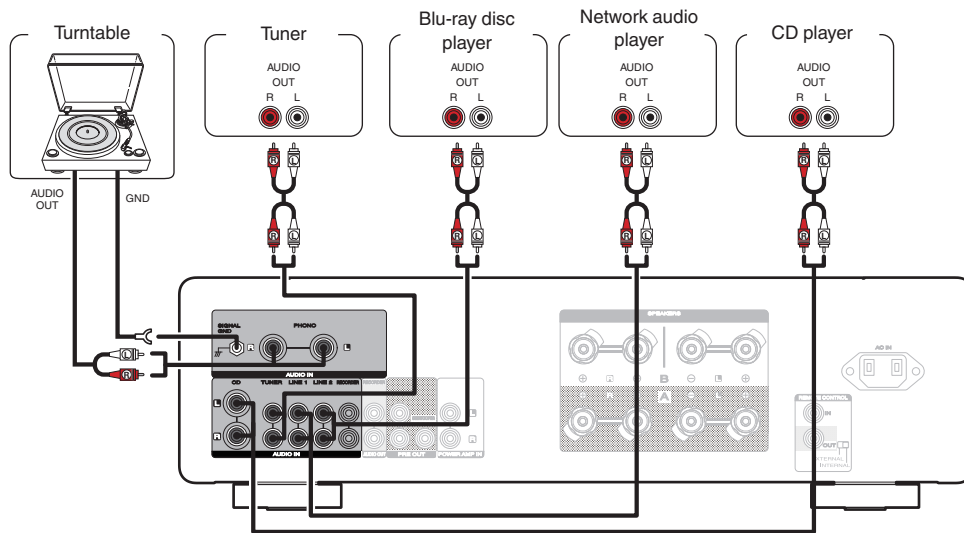

NOTE

- The earth terminal (SIGNAL GND) of this unit is not for safety grounding purposes. If this terminal is connected when there is a lot of noise, the noise can be reduced. Note that depending on the turntable, connecting the ground line may have the reverse effect of increasing noise. In this case, it is not necessary to connect the ground line.



- The PHONO input terminals are equipped with a short pin-plug. Remove this plug to connect a record player. Store the removed short pin-plug in a safe place so as not to lose it.



Connecting a recording device

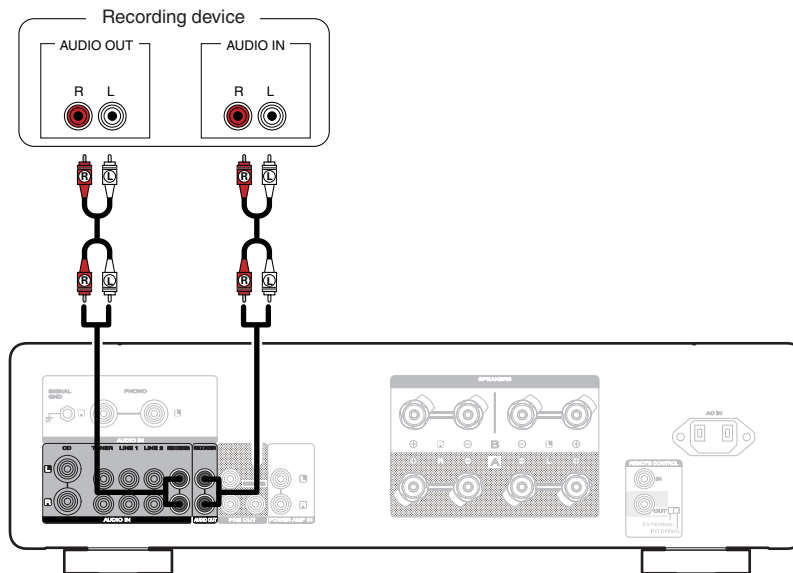

NOTE

- Never insert the short-circuiting pin plug into the recording output connectors (AUDIO OUT RECORDER). Doing so could result in damage.



Connecting a pre-amplifier or power amplifier

Connect a power amplifier to the unit to use it as a pre-amplifier, or connect a pre-amplifier to the unit to use it as a power amplifier.

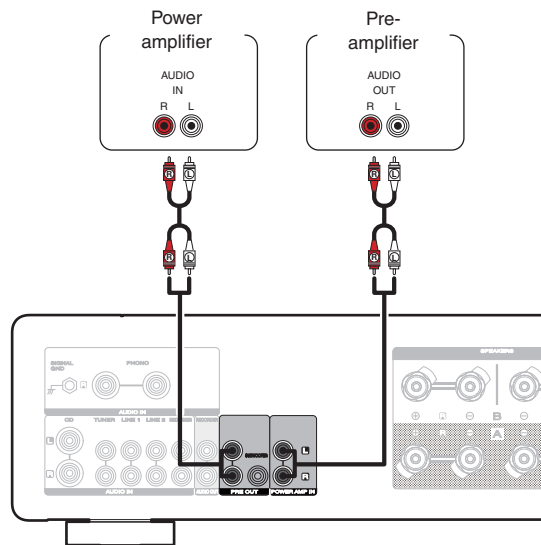

- When connecting a pre-amplifier and using this unit as a power amplifier, switch the input source to “PWR AMP”. (🔍 p. 29)
- This unit does not output the audio signal from the PRE OUT connectors when the speaker output setting is off.
- The volume of the audio signal from the PRE OUT connectors is linked to the speakers A/B volume.

NOTE

- Never insert the short-circuiting pin plug into the PRE OUT connectors. Doing so could result in damage.



Connecting devices with remote control connectors

Performing operations by RC on this unit without visual contact

You can connect an external IR receiver to the REMOTE CONTROL connectors to perform operations on this unit with the included remote control unit without visual contact. This might be necessary if the unit is hidden in a cupboard or corner, so you can't directly point with the remote control unit to the device.

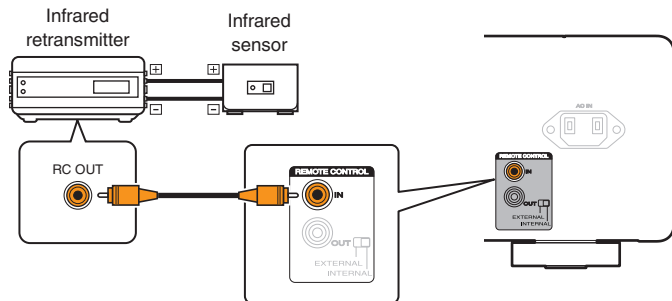

Remotely connecting Marantz audio devices

You can transmit remote control signals simply by connecting a Marantz audio device to the REMOTE CONTROL IN/OUT connectors using the remote connection cable provided with the device.

Set the EXTERNAL/INTERNAL switch on the rear panel of this unit and the connected device as follows.

- Turn this unit's EXTERNAL/INTERNAL switch to "EXTERNAL".
- Turn the EXTERNAL/INTERNAL switch of the connected device to "INTERNAL".

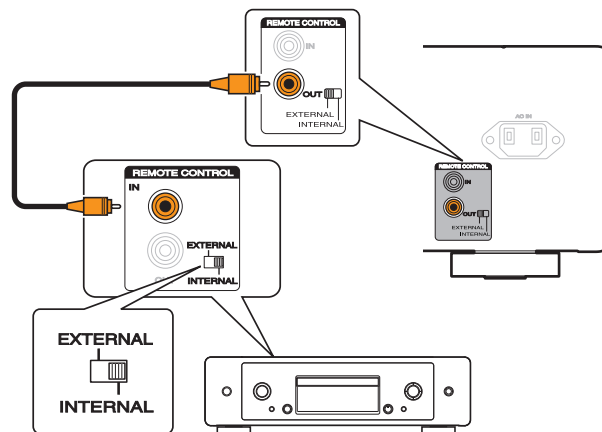



- This setting will disable remote sensor reception of this unit.
- To operate the unit, point the remote control at the remote sensor of the Marantz audio device.
- To use this unit by itself without connecting a Marantz audio device, turn the switch to "INTERNAL".



Connecting the power cord

After completing all the connections, insert the power plug into the power outlet.

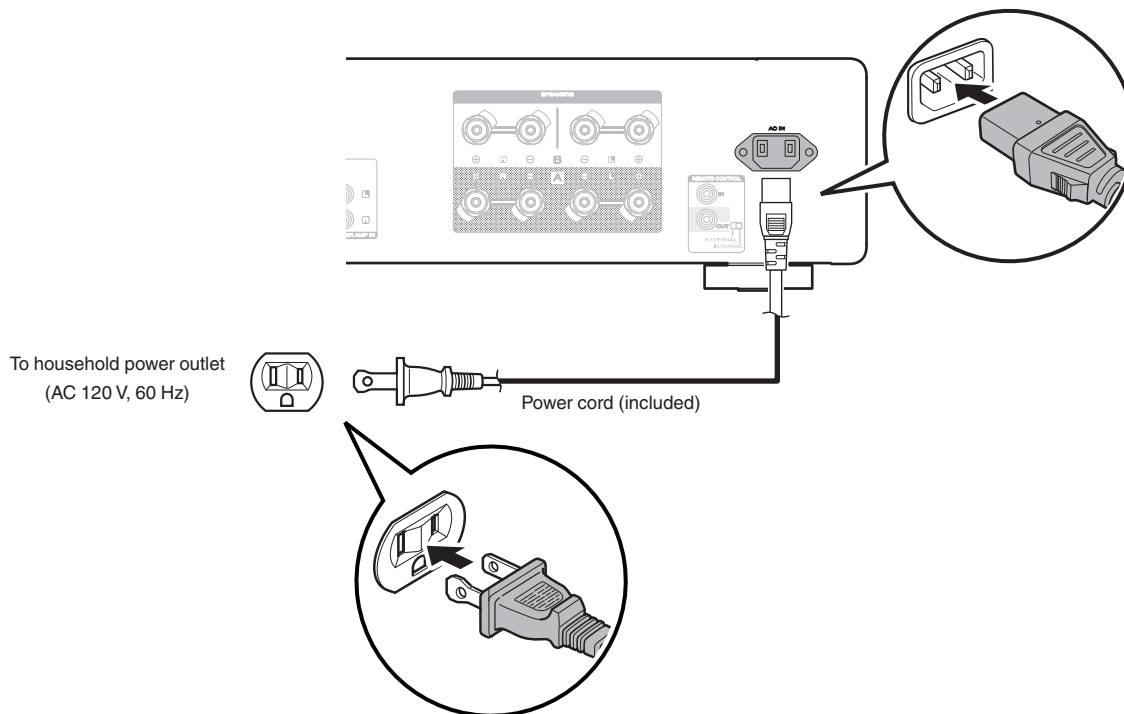

■ Contents

Turning the power on	26
Switching the power to standby	26
Selecting the speakers for audio output	27
Selecting the input source	27
Adjusting the volume	27
Turning off the sound temporarily (Muting)	28
Adjusting the tone and balance	28
Playback in source direct mode	28
Playing CDs	28
Using this unit as a power amplifier	29
Recording	29



Selecting the speakers for audio output

- 1 Turn the **SPEAKERS** selector knob on the main unit to select the speaker system to be used for playback.

SPEAKERS A (Default):	Outputs audio from speakers A only.
SPEAKERS B:	Outputs audio from speakers B only.
SPEAKERS A+B:	Outputs audio from both speakers A and speakers B.
SPEAKERS OFF:	No audio is output from the speakers.

Selecting the input source

- 1 Use **INPUT** \wedge \vee to select the input source to be played back.

The selected input source appears on the display.



- You can also select the input source by turning INPUT selector on the main unit.

Adjusting the volume

- 1 Use **VOLUME** $+$ $-$ to adjust the volume.

The volume level appears on the display.



- You can also adjust the volume by turning VOLUME on the main unit.



Turning off the sound temporarily (Muting)

1 Press **MUTE**.

"Mute" is displayed on the display.



- To cancel mute, either adjust the volume or press **MUTE** again.

Adjusting the tone and balance

1 Turn the **BASS**, **TREBLE** and **BALANCE** on the main unit to adjust the tone and balance.



- **BASS**, **TREBLE** and **BALANCE** cannot be adjusted when this unit is in source direct mode. Press **SOURCE DIRECT** on the remote control to turn off source direct mode.

Playback in source direct mode

The signal does not pass through the tone adjustment circuitry (**BASS**, **TREBLE** and **BALANCE**), resulting in playback of a higher sound quality.

- ### 1 Press **SOURCE DIRECT** to turn on source direct mode.
- "SOURCE DIRECT" is displayed on the display.

Playing CDs

This section uses playback from a CD as an example.

- ### 1 Press **AMP** to turn the power on.
- ### 2 Use **INPUT** to switch the input source to "CD".
- "CD" is displayed on the display.
- ### 3 Playback the CD.
- ### 4 Use **VOLUME** to adjust the volume.



Using this unit as a power amplifier

When connecting a pre-amplifier and using this unit as a power amplifier, switch the input source of this unit to “PWR AMP”.

1 Turn the INPUT selector on the main unit to switch the input source to “PWR AMP”.

“PWR AMP” is displayed on the display.



- When the input source is “PWR AMP”, adjustment of the volume, balance and tone has no effect. Adjust these adjustments on the pre-amplifier.
- When the remote control code setting is set to “AMP1” (Default), INPUT \wedge / \vee on the remote control cannot be used to switch the input source to “PWR AMP” or switch from “PWR AMP” to another input source. To make remote control operations, change the remote control code setting to “AMP2” or “AMP3”. (🔗 p. 33)

NOTE

- When the input source is “PWR AMP”, the main unit outputs at maximum volume. Check the output level on the input device before playing it and adjust the volume accordingly.

Recording

Audio signals input into this unit can be output to an external recording device. When recording audio from a playback device connected to this unit, audio can be recorded with the playback device still connected to this unit.

1 Press AMP \odot to turn the power on.

2 Use INPUT \wedge / \vee to switch to the input source from which you want to record.

The selected input source appears on the display.

3 Recording starts.

- For information on operations, see the owner’s manual of the recording device.



■ Contents

Setting the display's brightness	31
Setting the Auto Standby mode	32
Setting remote control codes	33



Setting the display's brightness



DIMMER

The display brightness can be adjusted between four levels. Switching the display off reduces a source of noise that affects sound quality, enabling higher sound quality playback.

1 Press DIMMER.

- The brightness of the display switches each time the button is pressed.



- If button operations are made while the display is off, information is temporarily displayed at the brightest setting.
- The display brightness is set to most brightly by default.
- DIMMER also works with Marantz Network CD player CD 50n (not included), so its brightness can be adjusted simultaneously when used in combination with this unit. If the devices have different brightness settings, press and hold DIMMER for 5 seconds or longer and adjust after they are both at the brightest setting.



Setting the Auto Standby mode

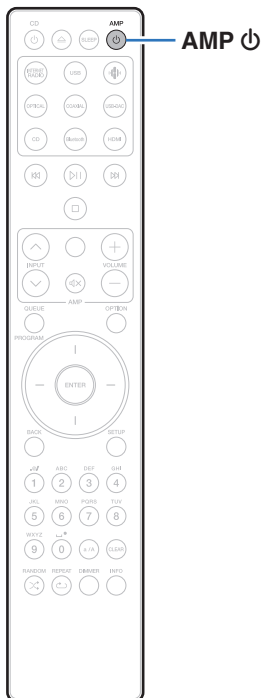

You can set the unit to automatically switch to standby mode if the unit is not operated for 15 minutes when there is no audio input (Auto Standby mode).

Auto Standby mode is set to off by default.

- 1 Press and hold AMP  for 5 seconds or more to switch it on and off.**

“Auto STBY On” or “Auto STBY Off” is displayed on the display.



Setting remote control codes

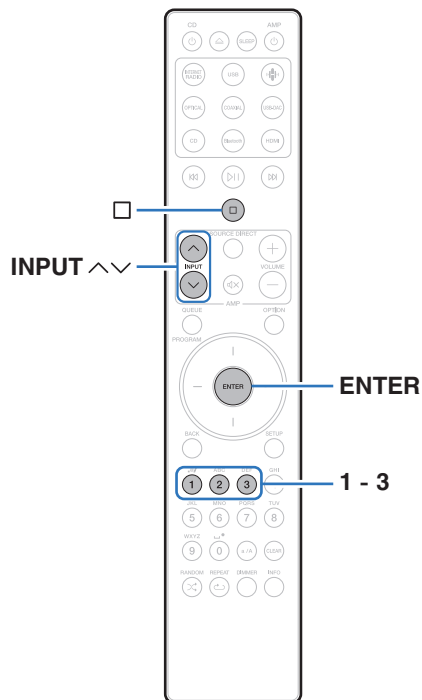

Remote control codes are set between this unit and the included remote control. You can select one of the three types of remote control codes, and the remote control can be used to control the unit when the same remote control code is used. If three of these units are used in the same location, all three units can be controlled simultaneously using one remote control in the default settings. By setting individual remote control codes between a unit and the remote control, the remote control can be used to control only the unit that has the same remote control code.

Be sure to check the operation of each unit after setting the remote control codes.

The default setting is “AMP1”.



- When remote control code setting is set to “AMP1”, the input source for this unit cannot be switched to “PWR AMP” using INPUT ^\u2193 on the remote control. To switch with the remote control, change the remote control code setting to “AMP2” or “AMP3”.
- Set the remote control cord to “AMP 1” when controlling this unit from a Marantz network CD player or other device connected using a remote connection cable to this unit. (🔗 p. 22)



Setting remote control codes for the remote control

■ To set the remote control codes to AMP1, AMP2 or AMP3

- 1 Hold down \square and one of the number 1, 2 or 3 buttons for more than 5 seconds.
 - Set the remote control code to AMP1, AMP2 or AMP3 according to the selected number button.

NOTE

- The remote control codes returns to the default settings when the batteries are removed. Set the remote control codes again after replacing the batteries.

Setting remote control codes for the main unit

- 1 Point the remote control for which the remote control code was set at the main unit, and press \square and ENTER.
When setting the remote control code of the main unit is complete, the remote control code set (AMP 1 – 3) is displayed on the display.



■ Contents

Tips

I want to adjust the tone myself	36
I want sound playback that is faithful to the original sound	36
I want to turn the display off	36
I want to use bi-wiring compatible speakers	36
I want to operate a Marantz Network CD player using the remote control of this unit	36
I want to use this unit as a power amplifier	36
I want to use this unit as a pre-amplifier	36
I want to use more than one unit in one location	36

Troubleshooting

Power does not turn on / Power is turned off	38
Operations cannot be performed through the remote control unit	40
Display on this unit shows nothing	41
No sound comes out	41
Desired sound does not come out	42
Sound is interrupted or noise occurs	43



Tips

I want to adjust the tone myself

- Use the BASS, TREBLE and BALANCE knobs to adjust the sound as desired. (👉 p. 28)

I want sound playback that is faithful to the original sound

- Set the source direct mode on. (👉 p. 28)

I want to turn the display off

- Press the DIMMER button to turn the display off. (👉 p. 31)

I want to use bi-wiring compatible speakers

- This unit is compatible with bi-wiring connections. Enjoy high quality playback by using bi-wiring connections. (👉 p. 17)

I want to operate a Marantz Network CD player using the remote control of this unit

- Marantz Network CD Players can also be operated with the remote control of this unit. Also refer to the Network CD player's instruction manuals. (👉 p. 11)

I want to use this unit as a power amplifier

- Connect a pre-amplifier to the POWER AMP IN connectors of this unit and switch the input source to "PWR AMP". (👉 p. 21)

I want to use this unit as a pre-amplifier

- Connect a power amplifier to the PRE OUT connectors of this unit. (👉 p. 21)

I want to use more than one unit in one location

- Set individual remote control codes for each combination of devices and remote control. (👉 p. 33)



Troubleshooting

If a problem should arise, first check the following:

1. **Are the connections correct?**
2. **Is the set being operated as described in the owner's manual?**
3. **Are the other devices operating properly?**



If this unit does not operate properly, check the corresponding symptoms in this section.

If the symptoms do not match any of those described here, consult your dealer as it could be due to a fault in this unit. In this case, disconnect the power immediately and contact the store where you purchased this unit.



Power does not turn on / Power is turned off

Power is not turned on.

- Check whether the power plug is correctly inserted into the power outlet. (👉 p. 24)
- This unit is in standby mode. Press the  button on the unit or the AMP  button on the remote control. (👉 p. 26)

Power automatically turns off.

- The Auto Standby mode is on. When approx. 15 minutes pass with no audio input and no operations on the unit, this unit automatically enters the standby mode. To turn off the Auto Standby mode, press the AMP  button for 5 seconds or longer. (👉 p. 32)
- When this unit and a Marantz audio device compatible with the power synchronization function are connected using a remote connection cable, the power of this unit turns off (standby) in synchronization with the power off operation of the device connected to this unit. (👉 p. 22)

The power turns off and the protection circuit indicator shows one long blink and two short blinks in orange.

- Stop playback on the playback device, and then turn the power off and on again.
- If the problem is not solved by turning the power off and on again, this unit's amplifier circuit has failed. Unplug the power cord and contact our customer service center.

The power turns off and the protection circuit indicator shows one long blink and three short blinks in orange.

- This unit's power circuit has failed. Unplug the power cord and contact our customer service center.



The power turns off and the protection circuit indicator shows one long blink and four short blinks in orange.

- The protection circuit has been activated due to a rise in temperature within this unit. Turn the power off, wait about an hour until this unit cools down sufficiently, and then turn the power on again.
- Please re-install this unit in a place having good ventilation.
- Stop playback on the playback device, and then turn the power off and on again.

The power turns off and the protection circuit indicator shows one long blink and five short blinks in orange.

- Check the speaker connections. The protection circuit may have been activated because speaker cable core wires came in contact with each other or a core wire was disconnected from the connector and came in contact with the rear panel of this unit. After unplugging the power cord, take corrective action such as firmly re-twisting the core wire or taking care of the connector, and then reconnect the wire. (👉 p. 14)
- Stop playback on the playback device, and then turn the power off and on again.
- If the problem is not solved by turning the power off and on again, this unit's amplifier circuit or power circuit has failed. Unplug the power cord and contact our customer service center.



Operations cannot be performed through the remote control unit

Operations cannot be performed through the remote control unit.

- Batteries are worn out. Replace with new batteries. (👉 p. 5)
- Operate the remote control unit within a distance of about 23 ft/7 m from this unit and at an angle of within 30°. (👉 p. 5)
- Remove any obstacle between this unit and the remote control unit.
- Insert the batteries in the proper direction, checking the ⊕ and ⊖ marks. (👉 p. 5)
- The set's remote control sensor is exposed to strong light (direct sunlight, inverter type fluorescent bulb light, etc.). Move the set to a place in which the remote control sensor will not be exposed to strong light.
- When using a 3D video device, the remote control unit of this unit may not function due to effects of infrared communications between units (such as TV and glasses for 3D viewing). In this case, adjust the direction of units with the 3D communications function and their distance to ensure they do not affect operations from the remote control unit of this unit.
- The remote control code of the volume buttons on the remote control (VOLUME + - and 🔊) is set to the mode for operating a Marantz Network CD player. If the volume of this unit cannot be adjusted using the remote control, press and hold ENTER and the number 1 button together for 5 seconds or more to change the remote control code to AMP operation mode.
- When the remote control code setting is set to "AMP1" (Default), the INPUT ^ v buttons on the remote control cannot be used to switch the input source to "PWR AMP" or switch from "PWR AMP" to another input source. To make remote control operations, change the remote control code setting to "AMP2" or "AMP3". (👉 p. 33)
- The remote control code between this unit and the remote control is different. Set this unit and the remote control to the same remote control code. (👉 p. 33)
- When using this unit independently, set the switch to INTERNAL. (👉 p. 22)



Display on this unit shows nothing

Display is off.

- Press the DIMMER button, and change the setting to anything other than off. (👉 p. 31)

No sound comes out

No sound comes out of speakers.

- Check the connections for all devices. (👉 p. 13)
- Insert connection cables all the way in.
- Check that input connectors and output connectors are not reversely connected.
- Check cables for damage.
- Check that speaker cables are properly connected. Check that cable core wires come in contact with the metal part on speaker terminals. (👉 p. 14)
- Securely tighten the speaker terminals. Check speaker terminals for looseness. (👉 p. 14)
- Check that the proper input source is selected. (👉 p. 27)
- The volume is set to the minimum level. Adjust the volume to a suitable level. (👉 p. 27)
- Cancel the muting mode. (👉 p. 28)
- Make sure that the settings for the speakers that output audio are appropriate. (👉 p. 27)



Desired sound does not come out

No sound comes out of a specific speaker.

- Check that speaker cables are properly connected. (🔗 p. 14)
- Adjust the BALANCE control knob. (🔗 p. 28)

No sound is produced from subwoofer.

- Check the subwoofer connections. (🔗 p. 18)
- Turn on the subwoofer's power.

The settings of the BASS, TREBLE and BALANCE knobs are not applied.

- Press the SOURCE DIRECT button to turn off source direct mode. (🔗 p. 28)

The left and right of stereo sound is reversed.

- Check whether the left and right speakers are connected to the correct speaker terminals. (🔗 p. 16)

Sound is not correctly output from the power amplifier connected to the PRE OUT connectors.

- Check the power amplifier connections. (🔗 p. 21)
- The audio signal is not outputted from the PRE OUT connectors when the speaker output setting is off. Set the speakers A/B output. (🔗 p. 27)
- The volume of the audio signal from the PRE OUT connectors is linked to the speakers A/B volume. Adjust the volume to a suitable level. (🔗 p. 27)

Sound is not correctly output from the pre amplifier connected to the POWER AMP IN connectors.

- Check the pre amplifier connections. (🔗 p. 21)
- Check the the input source of this unit is set to "PWR AMP". (🔗 p. 27)



Sound is interrupted or noise occurs

When playing a record, the sound is distorted.

- Adjust to a proper needle pressure.
- Check the tip of the needle.
- Replace the cartridge.

When playing a record, a humming noise comes out of the speakers.

- Check that the turntable is connected correctly. (👉 p. 19)
- If there is a TV or AV device near the turntable, such devices may affect the playback sound. Install the turntable in a location as far away as possible from the TV or other AV devices.

When playing a record, a humming noise comes out of the speakers when the volume is high. (Howling phenomenon)

- Install the turntable and speakers as far from each other as possible. (👉 p. 19)
- The vibrations from the speakers are being transmitted to the player through the floor. Use cushions, etc., to absorb the speakers' vibrations.



Explanation of terms

Source direct

Playback with higher fidelity to the source becomes possible, as input audio signals are output by bypassing the tone control circuits (BASS/TREBLE/BALANCE).

Speaker impedance

This is an AC resistance value, indicated in Ω (ohms). Greater power can be obtained when this value is smaller.

Protection circuit

This is a function to prevent damage to devices within the power supply when an abnormality such as an overload, excess voltage occurs or over temperature for any reason.



Specifications

• RMS Power output (20 Hz – 20 kHz simultaneous drive of both channels) :	70 W x 2 (8 Ω/ohms load) 100 W x 2 (4 Ω/ohms load)
• Total harmonic distortion (20 Hz – 20 kHz simultaneous drive of both channels, 8 Ω/ohms load) :	0.02 %
• Frequency response (CD, 1 W, 8 Ω/ohms load) :	5 Hz – 100 kHz ±3 dB
• Damping factor (8 Ω/ohms load, 20 Hz – 20 kHz) :	100 and over
• Input sensitivity/impedance:	PHONO (MM): 1.4 mV / 47 kΩ/kohms CD, TUNER, LINE, RECORDER: 185 mV/16 kΩ/kohms POWER AMP IN: 1.5 V/15 kΩ/kohms
• Output voltage:	PRE OUT: 1.5 V SUBWOOFER OUT: 220 mV
• Maximum allowable PHONO input level (1 kHz) MM :	80 mV
• RIAA deviation (20 Hz – 20 kHz) :	±0.5 dB
• S/N (IHF-A, 8 Ω/ohms load) :	PHONO (MM): 87 dB (5 mV input) CD, TUNER, LINE, RECORDER: 113 dB (rated output) POWER AMP IN: 125 dB (rated output)
• Tone Control :	BASS (50 Hz): ±10 dB TREBLE (15 kHz): ±10 dB
• Operating temperature:	41 °F - 95 °F (5 °C - 35 °C)
• Power supply :	AC 120 V, 60 Hz
• Power consumption :	220 W
• Power consumption in standby mode :	0.3 W

For the purpose of improvement, the specifications and design are subject to change without notice.



■ Dimensions (Unit : in. (mm))

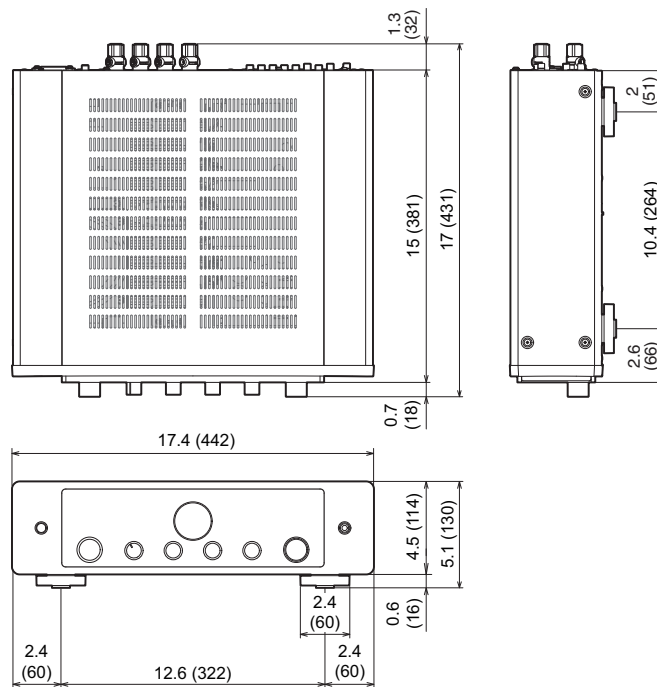

■ Weight : 31 lb 12 oz (14.4 kg)



Index

A		
Auto Standby mode	32	
B		
Blu-ray Disc player	19	
C		
CD player	19, 28	
F		
Front panel	6	
I		
Input source	27	
M		
Muting	28	
N		
Network audio player	19	
P		
Power amplifier	21	
Pre-amplifier	21	
Protection circuit	44	
R		
Rear panel	8	
Recording device	20	
Remote control codes settings	34	
Remote control unit	10	
S		
Source direct	28, 44	
Speaker impedance	44	
Speakers	14	
T		
Tips	36	
Tone	28	
Troubleshooting	37	
Tuner	19	
Turntable	19	
V		
Volume	27	



marantz

3520 10943 00AS

© 2023 DEI Sales, Inc. All Rights Reserved.